

# Modular Matrix Switcher

## FDX-S Series

FDX-S08U/S16U/S32U/S64U

<User Guide>

Ver.4.15.0

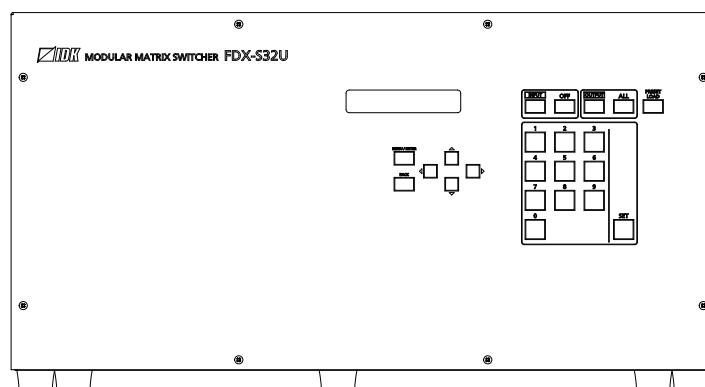
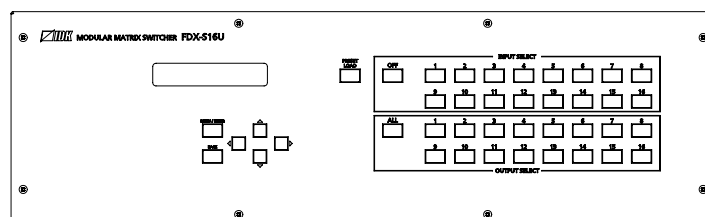

- Thank you for choosing our product.
- To ensure the best performance of this product, please read this user guide fully and carefully before using it and keep this manual together with the product for future reference as needed.

## Trademarks

- HDBaseT™ and the HDBaseT Alliance Logo are trademarks of the HDBaseT Alliance.
- The terms HDMI and HDMI High-Definition Multimedia Interface, and the HDMI Logo are trademarks or registered trademarks of HDMI Licensing Administrator, Inc. in the United States and other countries.
- SDVoE™ and SDVoE logo are trademarks of SDVoE Alliance.
- Audinate® is a registered trademark of Audinate Pty Ltd. Dante® is a registered trademark of Audinate Pty Ltd.
- All other company and product names mentioned in this document are either registered trademarks or trademarks of their respective owners. In this document, the “®” or “™” marks may not be specified.
- ©2020 IDK Corporation, all rights reserved.

# Before reading this manual

- All rights reserved.
- Some information contained in this user guide such as exact product appearance, diagrams, menu operations, and so on may differ depending on the product version.
- This user guide is subject to change without notice. You can download the latest version from IDK's website at: [www.idkav.com](http://www.idkav.com)

The reference manual consists of the following two volumes:

- User guide (this document):  
Provides explanations and procedures for operations, installation, connections among devices, I/O adjustment and settings.
- Command guide: Please download the command guide from the website above.  
Provides explanations and procedures for external control using RS-232C and LAN communications.

**FCC STATEMENT**

**Note:** This equipment has been tested and found to comply with the limits for a Class A digital device, pursuant to part 15 of the FCC Rules. These limits are designed to provide reasonable protection against harmful interference when the equipment is operated in a commercial environment. This equipment generates, uses, and can radiate radio frequency energy and, if not installed and used in accordance with the instruction manual, may cause harmful interference to radio communications. Operation of this equipment in a residential area is likely to cause harmful interference, in which case the user will be required to correct the interference at his own expense.

(Class A)

**Supplier's Declaration of Conformity  
47 CFR § 2.1077 Compliance Information**

**Unique Identifier**

Type of Equipment: MODULAR MATRIX SWITCHER

Model Name: FDX-S08U, FDX-S16U, FDX-S32U, FDX-S64U

- FDX-S Input Board: FDX-SIV4UH, FDX-SIV4UC, FDX-SIV4UT, FDX-SIV4US, FDX-SIV4S
- FDX-S Output Board: FDX-SOV4UH, FDX-SOV4UC, FDX-SOV4UT, FDX-SOV4US, FDX-SOV2UHS, FDX-SOV1UHM, FDX-SOV4HS, FDX-SOV4TS
- FDX-S Analog Audio Board: FDX-SAB4A, FDX-SOA12A
- FDX-S Network Audio Board: FDX-SAB64D
- Redundant Power Supply Unit: FDX-SRP08, FDX-SRP16, FDX-SRP32, FDX-SRP64

**Responsible Party – U.S. Contact Information**

Company Name: IDK America Inc.

Address: 72 Grays Bridge Road Suite 1-C, Brookfield, CT 06804

Telephone number: +1-203-204-2445

URL: www.idkav.com

**FCC Compliance Statement**

This device complies with Part 15 of the FCC Rules. Operation is subject to the following two conditions: (1) This device may not cause harmful interference, and (2) this device must accept any interference received, including interference that may cause undesired operation.

(FCC SDoC)

**CE MARKING**

This equipment complies with the essential requirements of the relevant European health, safety and environmental protection legislation.

**WEEE MARKING**



Waste Electrical and Electronic Equipment (WEEE), Directive 2002/96/EC

(This directive is only valid in the EU.)



This equipment complies with the WEEE Directive (2002/96/EC) marking requirement.







The left marking indicates that you must not discard this electrical/electronic equipment in domestic household waste.

# Safety Instructions

Read all safety and operating instructions before using this product. Follow instructions and heed warnings/cautions.

Instructions and warnings/cautions for all products are provided. Some of them may not be applicable to your product.

	<h2 style="margin: 0;">Warning</h2>	Indicates the presence of a hazard that may result in death or serious personal injury if the warning is ignored or the product is handled incorrectly.
	<h2 style="margin: 0;">Caution</h2>	Indicates the presence of a hazard that may cause minor personal injury or property damage if the caution is ignored or the product is handled incorrectly.

Symbol	Description	Example
 Caution	This symbol is intended to alert the user. (Warning and caution)	 Hot surfaces Caution
 Prohibited	This symbol is intended to prohibit the user from specified actions.	 Do not disassemble
 Instruction	This symbol is intended to instruct the user.	 Unplug

## Warning

### For lifting heavy products:

 Instruction	<ul style="list-style-type: none"> <li>• <b>Lifting must be done by two or more personnel.</b></li> </ul> <p>To avoid injury: When lifting the product, bend your knees, keep your back straight and get close to it with two or more persons.</p>
--	--





### For installing and connecting products:

 Prohibited	<ul style="list-style-type: none"> <li>• <b>Do not place the product in unstable place.</b></li> </ul> <p>Install the product in a horizontal and stable place, as this may fall or tip over and cause injury.</p> <ul style="list-style-type: none"> <li>• <b>Secure the product if installing in the locations with vibration.</b></li> </ul> <p>Vibration may move or tip over the product unexpectedly, resulting in injury.</p>
---	--

# Warning

 <b>Instruction</b>	<ul style="list-style-type: none"> <li>● <b>Installation work must be performed by professionals.</b> The product is intended to be installed by skilled technicians. For installation, please contact a system integrator or IDK. Improper installation may lead to the risk of fire, electric shock, injury, or property damage.</li> <li>● <b>Insert the power plug into an outlet that is unobstructed.</b> Unobstructed access to the plug enables unplugging the product in case of any extraordinary failure, abnormal situation or for easy disconnection during extended periods of non-use.</li> <li>● <b>Insert the power plug into an appropriate outlet completely.</b> If the plug is partially inserted, arcing may cause the connection to overheat, increasing the risk of electric shock or fire. Do not use a damaged plug or connect to a loose outlet.</li> <li>● <b>Unplug the product from an AC power source during installation or service.</b> When connecting peripheral devices to this product, unplug all involved devices from outlets. Ground potential differences may cause fire or other difficulties.</li> <li>● <b>The product must be electrically earthed/grounded.</b> To reduce the risk of electric shock, ensure the product is connected to a mains socket outlet with a protective earthing connection.</li> <li>● <b>For powering/powered functions, compatible cables must be used.</b> Otherwise, it may cause problems or a fire.</li> </ul>
---	---

**For operating products:**

 <b>Prohibited</b>	<ul style="list-style-type: none"> <li>● <b>Keep out any foreign objects.</b> To avoid fire or electric shock, do not permit foreign objects, such as metal and paper, to enter the product from vent holes or other apertures.</li> <li>● <b>For power cable/plug and Category cable,</b> <ul style="list-style-type: none"> <li>• Do not scratch, heat, or modify, including splicing or lengthening them.</li> <li>• Do not pull, place heavy objects on them, or pinch them.</li> <li>• Do not bend, twist, tie or clamp them together forcefully.</li> </ul> </li> </ul> <p>Misuse of the power cable and plug may cause fire or electric shock. If power cables/plugs become damaged, contact your IDK representative.</p>
 <b>Do not disassemble</b>	<ul style="list-style-type: none"> <li>● <b>Do not repair, modify or disassemble.</b> Since the product includes circuitry that uses potentially lethal, high voltage levels, disassembly by unauthorized personnel may lead to the risk of fire or electric shock. For internal inspection or repair, contact your IDK representative.</li> </ul>
 <b>Do not touch</b>	<ul style="list-style-type: none"> <li>● <b>Do not touch the product and connected cables during electric storms.</b> Contact may cause electric shock.</li> </ul>
 <b>Instruction</b>	<ul style="list-style-type: none"> <li>● <b>Clean the power plug regularly.</b> If the plug is covered in dust, it may increase the risk of fire.</li> </ul>



**If the following problem occurs:**

 <b>Unplug</b>	<ul style="list-style-type: none"> <li>● <b>Unplug immediately if the product smokes, makes unusual noise, or produces a burning odor.</b></li> <li>● <b>Unplug immediately if the product is damaged by falling or having been dropped.</b></li> <li>● <b>Unplug immediately if water or other objects are directed inside.</b></li> </ul> <p>If you continue to use the product under these conditions, it may increase the risk of electric shock or fire. For maintenance and repair, contact your IDK representative.</p>
--	--







# Caution

## For installing and connecting products:

 <p><b>Prohibited</b></p>	<ul style="list-style-type: none"> <li>● <b>Do not place the product in a location where it will be subjected to high temperatures.</b> If the product is subjected to direct sunlight or high temperatures while under operation, it may affect the product's performance and reliability and may increase the risk of fire.</li> <li>● <b>Do not store or operate the product in dusty, oil smoke filled, or humid place.</b> Placing the product in such environment may increase the risk of fire or electric shock.</li> <li>● <b>Do not block the vent holes.</b> If ventilation slots are blocked, it may cause the product to overheat, affecting performance and reliability and may increase the risk of fire.</li> <li>● <b>Do not place or stack heavy items on the product.</b> Failure to observe this precaution may result in damage to the product itself as well as other property and may lead to the risk of personal injury.</li> <li>● <b>Do not exceed ratings of outlet and wiring devices.</b> Exceeding the rating of an outlet may increase the risk of fire and electric shock.</li> </ul>
 <p><b>No wet hands</b></p>	<ul style="list-style-type: none"> <li>● <b>Do not handle power plug with wet hands.</b> Failure to observe this precaution may increase the risk of electric shock.</li> </ul>
 <p><b>Instruction</b></p>	<ul style="list-style-type: none"> <li>● <b>Use and store the product within the specified temperature/humidity range.</b> If the product is used outside the specified range of temperature and humidity continuously, it may increase the risk of fire or electric shock.</li> <li>● <b>Do not place the product at elevations of 1.24 mi. (2,000 m) or higher above sea level.</b> Failure to do so may shorten the life of the internal parts and result in malfunctions.</li> <li>● <b>When mounting the product into the rack, provide sufficient cooling space.</b> Mount the product in a rack meeting EIA standards, and maintain spaces above and below for air circulation. For your safety as required, attach an L-shaped bracket in addition to the panel mount bracket kit to improve mechanical stability.</li> <li>● <b>Never insert screws without the rubber feet into the threaded holes on the bottom of the product.</b> Never insert screws alone into the threaded holes on the bottom of the product. Doing so may lead to damage when the screws contact electric circuitry or components inside the product. Reinstall the originally supplied rubber feet using the originally supplied screws only.</li> </ul>

**For operating products:**

 <p><b>Hot surfaces Caution</b></p>	<p><b>For products with the hot surfaces caution label only:</b></p> <ul style="list-style-type: none"> <li>● <b>Do not touch the product's hot surface.</b></li> </ul> <p>If the product is installed without enough space, it may cause malfunction of other products. If you touch product's hot surface, it may cause burns.</p>
 <p><b>Prohibited</b></p>	<ul style="list-style-type: none"> <li>● <b>Use only the supplied power cable and AC adapter.</b></li> <li>● <b>Do not use the supplied power cable and AC adapter with other products.</b></li> </ul> <p>If non-compliant adapter or power cables are used, it may increase the risk of fire or electric shock.</p>
 <p><b>Unplug</b></p>	<ul style="list-style-type: none"> <li>● <b>If the product won't be used for an extended period of time, unplug it.</b></li> </ul> <p>Failure to observe this precaution may increase the risk of fire.</p> <ul style="list-style-type: none"> <li>● <b>Unplug the product before cleaning.</b></li> </ul> <p>To prevent electric shock.</p>
 <p><b>Instruction</b></p>	<ul style="list-style-type: none"> <li>● <b>Do not prevent heat release.</b></li> </ul> <p>If cooling fan stops, power off the product and contact IDK. Failure to do so may raise internal temperature and increase the risk of malfunction, fire, or electric shock.</p> <ul style="list-style-type: none"> <li>● <b>Keep vents clear of dust.</b></li> </ul> <p>If the vent holes near the cooling fan or near the fan are covered with dust, internal temperatures increase and may increase the risk of malfunction. Clean the vent holes and near the fan as needed. If dust accumulates inside of the product, it may increase the risk of fire or electric shock. Periodic internal cleaning, especially before humid rainy season, is recommended. For internal cleaning, contact your IDK representative.</p>

## Table of Contents

1 About this Guide .....	14
2 Included items.....	16
3 About FDX-S Module Matrix Switchers .....	18
4 Features.....	20
5 Panels .....	22
5.1 Frame .....	22
5.1.1 FDX-S08U .....	22
5.1.2 FDX-S16U .....	24
5.1.3 FDX-S32U .....	26
5.1.4 FDX-S64U .....	29
5.2 I/O boards .....	32
5.3 Audio board.....	33
5.4 Redundant power supply unit .....	33
6 System Configuration Example .....	34
7 Installation.....	35
7.1 Precautions .....	35
7.2 Rack mounting brackets .....	35
8 Connection Details.....	36
8.1 Precautions .....	36
8.2 Connecting video devices .....	36
8.2.1 HDMI cable.....	37
8.2.2 Cable Lacing Bracket .....	37
8.2.3 HDBaseT input and output connectors .....	38
8.2.4 Category cable .....	39
8.2.5 Category cable for SDVoE .....	40
8.2.6 Coaxial cable .....	41
8.3 Connecting control devices.....	42
8.3.1 RS-232C communication .....	42
8.3.2 LAN communication .....	43
8.3.3 Alarm .....	43
8.4 Connecting audio devices.....	44
8.4.1 Analog audio connector.....	46
8.5 Connecting power cord .....	46
9 Operation .....	47
9.1 Powering on/off .....	47
9.2 Front panel operations .....	48
9.2.1 Selecting menu.....	48
9.2.2 Selecting output video .....	49
9.2.3 Recalling preset memory.....	53
9.2.4 Front panel security lockout .....	55
9.2.5 Initialization.....	55
9.3 WEB browser operations .....	56
9.3.1 Starting WEB browser .....	56
9.3.2 Setting account.....	57
9.3.3 Logging in WEB browser.....	58
9.3.4 Logging out WEB browser.....	59
9.3.5 Normal/Advanced menu.....	60

9.3.6	Setting login feature .....	61
9.3.7	Setting secure connection .....	63
9.3.8	Selecting server certificate .....	63
9.3.9	Selecting valid period of server certificate.....	64
9.3.10	Storing server certificate.....	64
9.3.11	Editing crosspoint name .....	65
9.3.12	Displaying HDBaseT information .....	66
9.3.13	Registering bitmap .....	69
9.3.14	Crosspoint menu for audio board.....	70
9.3.15	Automatic reload .....	71
9.3.16	Saving/Restoring settings.....	71
9.3.17	Initialization.....	73
9.4	Dante.....	74
9.4.1	Dante network connection.....	77
9.4.2	Dante Controller .....	78
9.5	Controlled by IP-NINJAR Configurator .....	78
10	Configuration and Control.....	79
10.1	Board channel configuration .....	79
10.2	Menu .....	80
10.2.1	Normal setting menu .....	81
10.2.2	Advanced setting menu.....	82
10.3	Displaying crosspoint .....	86
10.4	Output position, size, and masking .....	87
10.4.1	Output resolution .....	87
10.4.2	Aspect ratio for sink device .....	88
10.4.3	Image position .....	88
10.4.4	Image size .....	89
10.4.5	Background color .....	90
10.4.6	Test pattern .....	90
10.4.7	Videowall configuration .....	91
10.4.8	Videowall position.....	92
10.4.9	Frame delay.....	92
10.4.10	Synchronization mode.....	93
10.4.11	Video synchronization .....	94
10.5	Output .....	101
10.5.1	Disabling synchronous signal output when no video signal is input .....	101
10.5.2	Output video for when no input video.....	101
10.5.3	HDCP output .....	102
10.5.4	Output equalizer .....	103
10.5.5	Output format.....	104
10.5.6	Output RGB range.....	104
10.5.7	HDBaseT output long reach mode .....	105
10.5.8	Deep Color output .....	105
10.5.9	Window transition effect .....	106
10.5.10	Sink device EDID check.....	107
10.5.11	Hot plug ignoring duration .....	108
10.5.12	DDC power output when no signal is input .....	108
10.5.13	SDI output format conversion.....	109
10.5.14	SDI output gearbox mode .....	110
10.6	Input position, size, and cropping .....	113

10.6.1 Aspect ratio.....	113
10.7 Input.....	114
10.7.1 No-signal input monitoring.....	114
10.7.2 HDCP input.....	115
10.7.3 HDBaseT input long reach mode.....	116
10.7.4 3G-SDI Dual Stream signal input.....	116
10.7.5 SDI input gearbox mode.....	117
10.8 Input timing.....	122
10.8.1 Horizontal start position.....	122
10.8.2 Horizontal active area.....	123
10.8.3 Vertical start position.....	123
10.8.4 Vertical active area.....	123
10.9 Picture controls.....	124
10.9.1 Output brightness.....	124
10.9.2 Output contrast.....	124
10.9.3 Output gamma.....	124
10.9.4 Output video correction initialization.....	125
10.9.5 Input sharpness.....	125
10.9.6 Input brightness.....	125
10.9.7 Input contrast.....	125
10.9.8 Input hue.....	126
10.9.9 Input saturation.....	126
10.9.10 Input video correction initialization.....	126
10.10 Output audio.....	127
10.10.1 Mute.....	127
10.10.2 Output Lip Sync.....	127
10.10.3 Audio embedding.....	128
10.10.4 Audio de-embedding.....	129
10.10.5 Audio setting.....	130
10.10.6 SDI output audio group.....	130
10.11 Input audio.....	131
10.11.1 Stable audio input wait.....	131
10.11.2 SDI input audio group.....	131
10.12 EDID.....	132
10.12.1 Resolution.....	133
10.12.2 Copying EDID.....	136
10.12.3 External EDID.....	136
10.12.4 HDMI/DVI.....	136
10.12.5 Frame rate.....	137
10.12.6 Deep Color.....	137
10.12.7 LPCM audio.....	137
10.12.8 AAC audio.....	138
10.12.9 Dolby Digital audio.....	138
10.12.10 Dolby Digital Plus audio.....	138
10.12.11 Dolby TrueHD audio.....	139
10.12.12 DTS audio.....	139
10.12.13 DTS-HD audio.....	139
10.12.14 Speaker configuration.....	140
10.13 RS-232C.....	141
10.13.1 RS-232C communication.....	141

10.14 LAN .....	141
10.14.1 IP address .....	141
10.14.2 Subnet mask .....	141
10.14.3 Gateway address .....	142
10.14.4 MAC address.....	142
10.14.5 TCP port number.....	142
10.14.6 Output LAN of extension connector .....	142
10.14.7 Input LAN of extension connector .....	142
10.14.8 Sending SDVoE device detection packet (Output) .....	143
10.14.9 Sending SDVoE device detection packet (Input) .....	143
10.14.10 Automatic disconnection time (Timeout).....	143
10.15 Preset memory.....	144
10.15.1 Recalling crosspoint .....	144
10.15.2 Saving crosspoint .....	144
10.15.3 Editing crosspoint .....	145
10.15.4 Recalling preset memory.....	146
10.15.5 Saving preset memory .....	146
10.15.6 Start-up setting .....	147
10.16 Bitmap .....	148
10.16.1 Bitmap image output .....	149
10.16.2 Background color .....	149
10.16.3 Aspect ratio.....	149
10.16.4 Image position .....	150
10.16.5 Start-up bitmap output.....	150
10.16.6 Memory mode of bitmap file .....	151
10.17 Multi window output .....	152
10.17.1 Window position .....	154
10.17.2 Window size .....	155
10.17.3 Aspect Ratio .....	155
10.17.4 Image position .....	156
10.17.5 Image size .....	157
10.17.6 Window background color .....	158
10.17.7 Window layer order .....	159
10.17.8 Window transition effect .....	159
10.17.9 Window ON/OFF .....	160
10.17.10 Overlay text position.....	160
10.17.11 Overlay text size .....	161
10.17.12 Window border size.....	161
10.17.13 Window border color .....	161
10.17.14 Window video synchronization.....	162
10.17.15 Recalling multi window memory.....	163
10.17.16 Saving multi window memory.....	164
10.18 Configuring FDX-S.....	165
10.18.1 Grouping front panel security lockout.....	165
10.18.2 Beep .....	165
10.18.3 Alarm .....	166
10.18.4 Displaying advanced menu .....	167
10.18.5 Power saving.....	167
10.18.6 Top page .....	168
10.18.7 Channel selection mode.....	172

10.19 Status indication.....	173
10.19.1 Input signal status .....	173
10.19.2 Sink device status .....	173
10.19.3 Viewing sink device EDID .....	173
10.19.4 System status.....	174
10.19.5 Viewing board status.....	175
10.19.6 Fan status.....	177
10.19.7 Power supply voltage status.....	177
10.19.8 Device information.....	177
10.20 Factory default list.....	178
11 License .....	182
12 Product specification.....	183
12.1 FDX-S08U.....	183
12.2 FDX-S16U.....	184
12.3 FDX-S32U.....	185
12.4 FDX-S64U.....	186
12.5 FDX-SIV4UH.....	187
12.6 FDX-SIV4UT .....	187
12.7 FDX-SIV4US.....	188
12.8 FDX-SIV4UC.....	188
12.9 FDX-SIV4S.....	189
12.10 FDX-SOV4UH.....	189
12.11 FDX-SOV4UT .....	190
12.12 FDX-SOV4US.....	191
12.13 FDX-SOV4UC.....	192
12.14 FDX-SOV4UHS.....	193
12.15 FDX-SOV2UHS.....	194
12.16 FDX-SOV1UHM.....	195
12.17 FDX-SOV4HS.....	196
12.18 FDX-SOV4TS.....	197
12.19 FDX-SAB4A.....	198
12.20 FDX-SOA12A.....	198
12.21 FDX-SAB64D.....	198
12.22 FDX-SRP08.....	199
12.23 FDX-SRP16.....	199
12.24 FDX-SRP32.....	199
12.25 FDX-SRP64.....	199
13 Troubleshooting.....	200

# 1 About this Guide

This guide contains installation, setting, and operating information for the FDX-S series Modular Matrix Switchers (hereafter referred to as “FDX-S”).

The FDX-S consists of the modular matrix switcher, redundant power supply unit, Input/Output boards, and audio boards.

[Table 1.1] FDX-S series

[1/2]

Item	Model	FDX			
		S08U	S16U	S32U	S64U
Max. input resolution		4K@60 (4:4:4)			4K@60 (4:2:0)
Max. output resolution		4K@60 (4:4:4)			
HDCP		1.4/2.2			
Max. inputs		8	16	32	64
Max. outputs		8	16	32	64
Redundant power supply (Optional) (FDX-SRP08/SRP16/SRP32/SRP64)		✓ (SRP08)	✓ (SRP16)	✓ (SRP32)	✓ (SRP64)
The number of mounted audio boards		1			2
I/O boards (4 I/Os per board)					
Input					
	4K@60 HDMI/DVI (FDX-SIV4UH)	✓	✓	✓	✓
	4K@60 HDBaseT (FDX-SIV4UT)	✓	✓	✓	✓
	12G-SDI/6G-SDI/3G-SDI/HD-SDI (FDX-SIV4US)	✓	✓	✓	✓
	4K@60 SDVoE (FDX-SIV4UC)	✓	✓	✓	✓
	3G-SDI/HD-SDI/SD-SDI (FDX-SIV4S)	✓	✓	✓	✓
Output					
	4K@60 HDMI/DVI (FDX-SOV4UH)	✓	✓	✓	✓
	4K@60 HDBaseT (FDX-SOV4UT)	✓	✓	✓	✓
	12G-SDI/6G-SDI/3G-SDI/HD-SDI (FDX-SOV4US)	✓	✓	✓	✓
	4K@60 SDVoE (FDX-SOV4UC)	✓	✓	✓	✓

Item	Model	FDX			
		S08U	S16U	S32U	S64U
I/O boards (4 I/Os per board) (Cont'd)					
Output					
4K@60 HDMI/DVI scan converter (FDX-SOV4UHS)		✓	✓	✓	✓
4K@60 HDMI/DVI scan converter (FDX-SOV2UHS)		✓	✓	✓	✓
<b>Note:</b> 2 outputs per board					
4K@60 HDMI/DVI scan converter multiview (FDX-SOV1UHM)		✓	✓	✓	N/A
<b>Note:</b> 1 output per board					
1080p HDMI/DVI scan converter (FDX-SOV4HS)		✓	✓	✓	✓
1080p HDBaseT scan converter (FDX-SOV4TS)		✓	✓	✓	✓
Audio boards					
Analog audio					
4 inputs Unbalanced 4 outputs Balanced/Unbalanced (FDX-SAB4A)		✓	✓	✓	✓
12 outputs Unbalanced (FDX-SOA12A)		✓	✓	✓	✓
Network audio					
1 input/output 64 Dante protocol channels (32 stereo channels) (FDX-SAB64D)		✓	✓	✓	✓

## 2 Included items

Ensure that all items illustrated below are included in the package.

If any items are missing or damaged, please contact IDK.

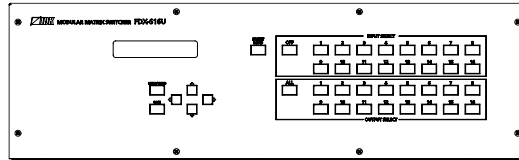

Frame (Example: FDX-S16U)

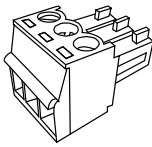

3-pin captive screw connector

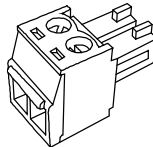

2-pin captive screw connector

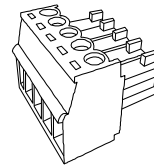

5-pin captive screw connector

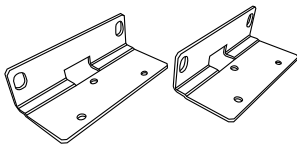

Rack mounting brackets  
(For FDX-S08U)

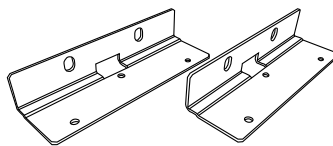

Rack mounting brackets  
(For FDX-S16U)

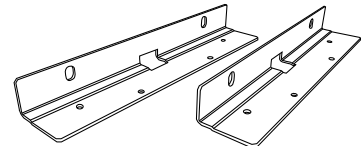

Rack mounting brackets  
(For FDX-S32U)

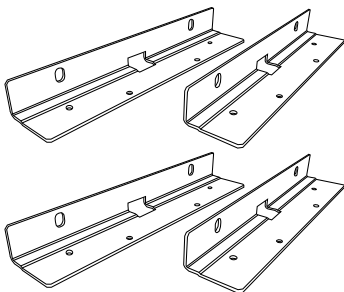

Rack mounting brackets  
(For FDX-S64U)



M4 screw

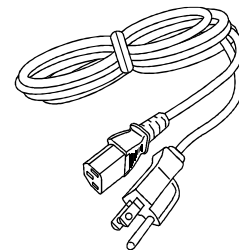

Power cord, 6 ft. (1.8 m)  
(For FDX-S08U/S16U)  
Power cord, 7 ft. (2.0 m)  
(For FDX-S32U/S64U)

**[Table 2.1] Included items**

Item	FDX		
	S08U/S16U	S32U	S64U
Frame	1	1	1
3-pin captive screw connector for RS-232C	1	1	1
2-pin captive screw connector for ALARM	1	1	1
3-pin/5-pin captive screw connectors for analog audio	Depends on the number of analog audio connectors		
Rack mounting brackets/M4 screw	Two (2) brackets/ 6 screws	Two (2) brackets/ 8 screws	Four (4) brackets/ 16 screws
Power cord, 6 ft. (1.8 m) for frame	1	–	–
Power cord, 6 ft. (1.8 m) for redundant power supply unit	1	–	–
Power cord, 7 ft. (2.0 m) for frame	–	1	1
Power cord, 7 ft. (2.0 m) for redundant power supply unit	–	1	1

### 3 About FDX-S Module Matrix Switchers

---

The FDX-S is an HDCP-compliant modular digital matrix switcher that supports resolutions up to 4K@60. It provides up to 64 inputs and 64 outputs. Video and embedded audio can be switched simultaneously.

With audio boards, input digital audio signals can be converted into output analog audio or Dante network audio signals. Input analog audio signals and Dante network audio signals can be converted into digital audio signals and embedded to desired output video channels.

The FDX-S features RS-232C/LAN ports for remote control, redundant power supply, and system check that outputs an alarm in case an abnormality is detected in power supply voltage, fans, internal temperature, board, or audio board.

WEB browser communication supports the TLS.

The redundant power supply ensures constant availability and minimizes the chance of a failure even for mission-critical environments.

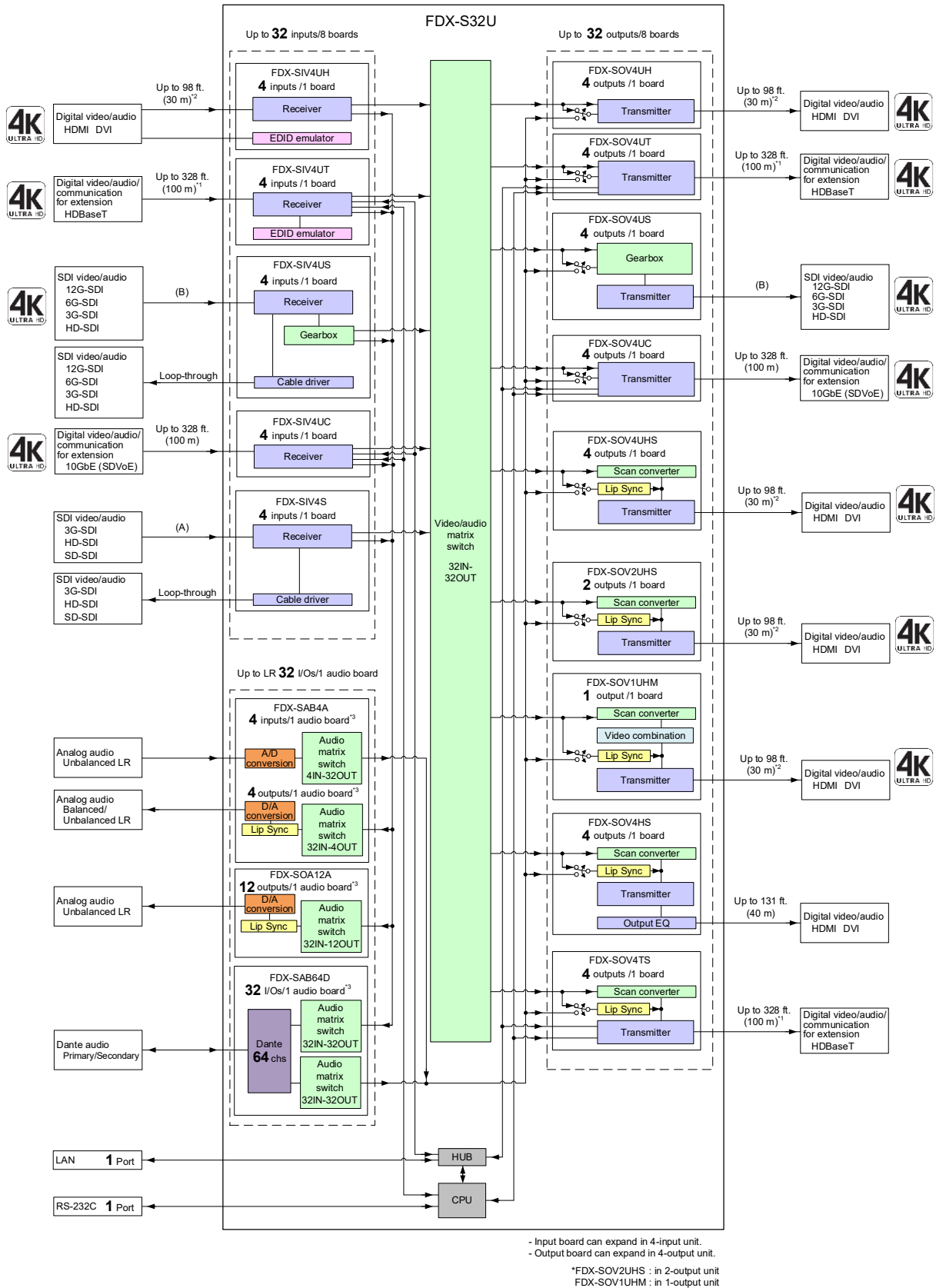

(A) SD-SDI : Up to 1312 ft. (400 m)/  
HD-SDI : Up to 787 ft. (240 m)/  
3G-SDI : Up to 459 ft. (140 m)  
over 1694A (BELDEN RG-6) cable

(B) HD-SDI : Up to 820 ft. (250 m)/  
3G-SDI : Up to 525 ft. (160 m)/  
6G-SDI : Up to 262 ft. (80 m)/  
12G-SDI : Up to 197 ft. (60 m)  
over 1694A (BELDEN RG-6) cable

<sup>1</sup> Up to 328 ft. (100 m) : 4K@60 (FDX-SIV4UT/FDX-SOV4UT)  
QWXA, 1080p (FDX-SOV4TS)  
Up to 492 ft. (150 m) : 1080p (24 bit) in Long reach mode  
For long reach mode, video signals up to 1080p (24 bit) can be transmitted to 492 ft. (150 m) at maximum  
if using with IDK's HDBaseT products supporting 328 ft. (100 m) transmission.

<sup>2</sup> Up to 98 ft. (30 m) : 1080p@60  
Up to 39 ft. (12m) : 4K@60 (when cable supporting 18 Gbps transmission is used)

<sup>3</sup> The number of inputs/outputs: the number of stereo L/R audio signal channels

[Fig. 3.1] Diagram (Example: FDX-S32U)

## 4 Features

[1/2]

Features		Remarks
Video	Maximum input resolution 4K@60 (4:4:4)	For FDX-S64U, up to 4K@60 (4:2:0)
	Maximum output resolution 4K@60 (4:4:4)	
	HDCP 1.4/2.2	
	HDR*1	FDX-SIV4UH, FDX-SIV4UT, FDX-SOV4UH, FDX-SOV4UT
	3D*1	
	x.v.Color*1	
	3G-SDI/HD-SDI/SD-SDI input	FDX-SIV4S
	12G-SDI/6G-SDI/3G-SDI/HD-SDI input	FDX-SIV4US For FDX-S64U, up to 6G-SDI
	12G-SDI/6G-SDI/3G-SDI/HD-SDI output	FDX-SOV4US
	Automatic signal equalization Output 131 ft. (40 m)	FDX-SOV4HS
	Up to 328 ft. (100 m) over Cat6 cable	FDX-SIV4UC, FDX-SOV4UC
	Up to 492 ft. (150 m) over Cat6 cable in Long reach mode*2	FDX-SIV4UT, FDX-SOV4UT, FDX-SOV4TS
	Up to 984 ft. (300 m) over coaxial cable	FDX-SIV4S
	Motion adaptive interlaced/progressive conversion	FDX-SOV4UHS, FDX-SOV2UHS, FDX-SOV1UHM, FDX-SOV4HS, FDX-SOV4TS
	Aspect ratio control	
	Seamless switching with one black frame	
	Anti-snow	FDX-SOV4UHS, FDX-SOV2UHS, FDX-SOV1UHM, FDX-SOV4HS, FDX-SOV4TS
	Scaling	FDX-SOV4UHS, FDX-SOV2UHS, FDX-SOV1UHM, FDX-SOV4HS, FDX-SOV4TS
	SDI Loop-through output connector	FDX-SIV4US, FDX-SIV4S
	SDI gearbox feature	FDX-SOV4US For FDX-S64U, this feature is not supported.
Videowall output	FDX-SOV4UHS, FDX-SOV2UHS, FDX-SOV1UHM, FDX-SOV4HS, FDX-SOV4TS	

\*1 If HDR/3D/x.v.Color video is input to the FDX-SOV4UHS, FDX-SOV2UHS, FDX-SOV1UHM, FDX-SOV4US, FDX-SIV4UC, FDX-SOV4HS, and FDX-SOV4TS, correct video signal is not output.

\*2 For long reach mode, video signals up to 1080p (24 bit) can be transmitted to 492 ft. (150 m) at maximum if using with IDK's HDBaseT products supporting 328 ft. (100 m) transmission.

[2/2]

Features		Remarks
Audio	Lip Sync	FDX-SOV4UHS, FDX-SOV2UHS, FDX-SOV1UHM, FDX-SOV4HS, FDX-SOV4TS, FDX-SAB4A, FDX-SOA12A
	Embedding	FDX-SAB4A
	De-embedding	FDX-SAB4A, FDX-SOA12A
	Dante I/O	FDX-SAB64D
Control input	RS-232C	
	LAN	
Others	EDID emulation	Input boards other than SDI input boards
	I/O board, CPU board, audio board, fan unit, and power unit can be replaced without removing from rack	
	Alarm output (Monitoring power supply voltage, fans, internal temperature, board, and audio board status)	
	Preset memory	
	Last memory	
	Connection Reset	Output boards other than SDI output boards and SDVoE output boards
	Button security lockout	
	System check	
	WEB browser control	
	Redundant power supply (Optional)	
	LAN and RS-232C transmission	FDX-SIV4UT, FDX-SIV4UC, FDX-SOV4UT, FDX-SOV4UC, FDX-SOV4TS
	Status notification	
	HDBaseT status display	FDX-SIV4UT, FDX-SOV4UT, FDX-SOV4TS

## 5 Panels

### 5.1 Frame

#### 5.1.1 FDX-S08U

● Front panel

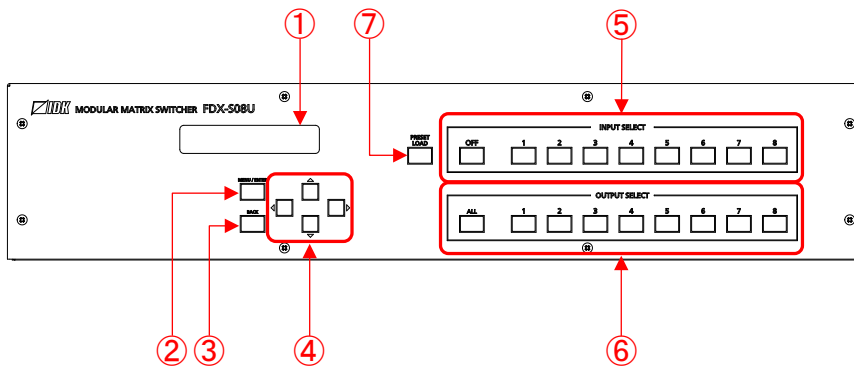

● Rear panels

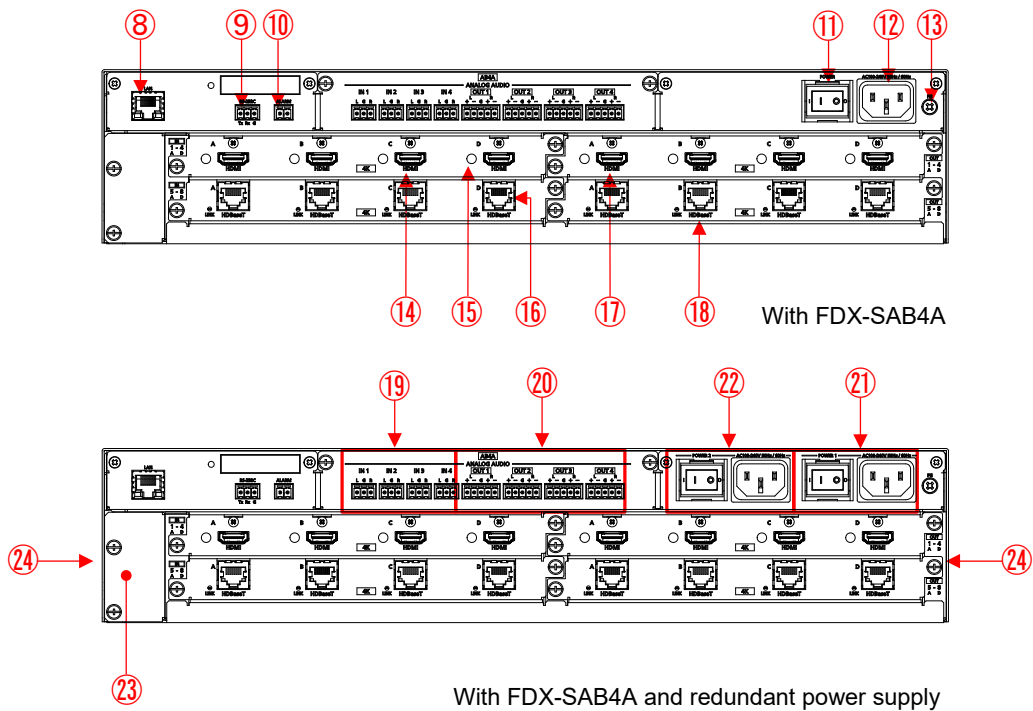

[Fig. 5.1] Drawings

**[Table 5.1] Features**

#	Feature	Description
<b>Front panel</b>		
①	Front display	Displays menus and settings.
②	MENU/ENTER button	Selects menus, edits, controls, and saves settings.
③	BACK button	Available only in menu pages. Goes back to the previous page.
④	Navigation buttons	Navigates menu or changes values of adjustable features.
⑤	INPUT SELECT button	Selects an input. Selects the preset memory number (in loading preset mode).
⑥	OUTPUT SELECT button	Selects an output.
⑦	PRESET LOAD button	Enables preset memory load mode.
<b>Rear panel</b>		
⑧	LAN connector	For external control by communication commands or web browsers
⑨	RS-232C connector	3-pin captive screw connector for RS-232C serial control
⑩	ALARM connector	Outputs an alert for abnormalities of power supply unit, cooling fan, internal temperature, board, and audio board status. Connector type is 2-pin captive screw connector.
⑪	Power switch (POWER)	Controls the power.
⑫	Power supply connector	For use with supplied power cable
⑬	Frame ground	Use for bonding chassis to local ground. An M4 screw is used.
⑭	HDMI input connectors	Input connectors for HDMI and DVI signals to interface source devices, such as Blu-ray players and computers.
⑮	HDMI cable fixing holes (Not used)	Not used.
⑯	HDBaseT input connector	Input connector for HDBaseT signals Connects to a transmitter over a category cable.
⑰	HDMI output connectors	Output connectors for HDMI and DVI signals, interfaces sink devices such as LC monitors and projectors
⑱	HDBaseT output connectors	Output connector for HDBaseT signal Connects to a receiver over a category cable.
⑲	Analog audio input connector	Input connectors (3-pin captive screw connector) for analog audio signals
⑳	Analog audio output connector	Output connectors (5-pin captive screw connector) for analog audio signals
㉑	Power supply unit (Primary)	Primary power supply unit for redundant power supply
㉒	Power supply unit (Secondary)	Secondary power supply unit for redundant power supply
㉓	Fan unit	Replaceable fan unit
<b>Side panel</b>		
㉔	Ventilation holes	Prevents internal temperature from rising. Do not block ventilation holes.

## 5.1.2 FDX-S16U

### ● Front panel

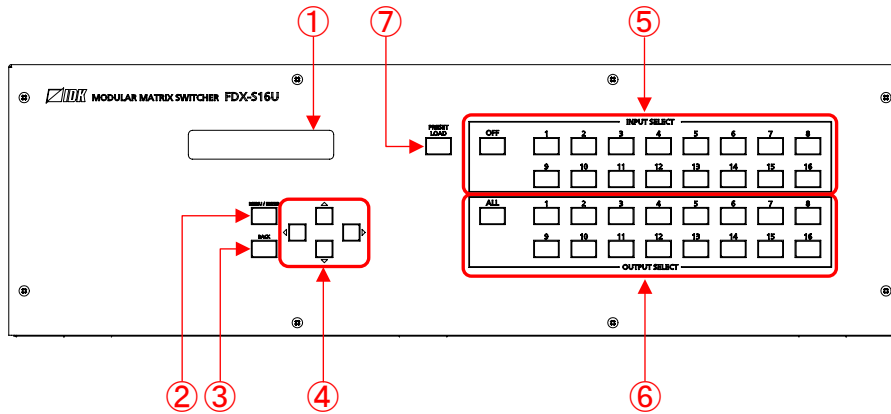

### ● Rear panels

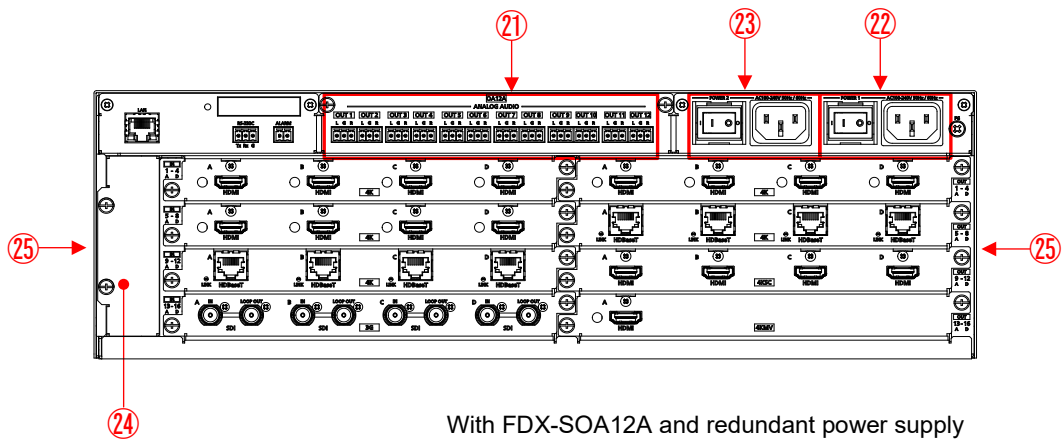
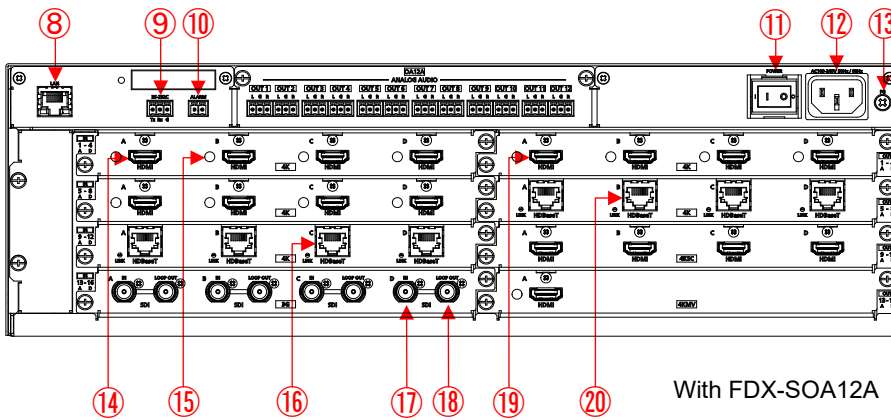

[Fig. 5.2] Drawings

**[Table 5.2] Features**

#	Feature	Description
<b>Front panel</b>		
①	Front display	Displays menus and settings.
②	MENU/ENTER button	Selects menus, edits, controls, and saves settings.
③	BACK button	Available only in menu pages. Goes back to the previous page.
④	Navigation buttons	Navigates menu or changes values of adjustable features.
⑤	INPUT SELECT button	Selects an input. Selects the preset memory number (in loading preset mode).
⑥	OUTPUT SELECT button	Selects an output.
⑦	PRESET LOAD button	Enables preset memory load mode.
<b>Rear panel</b>		
⑧	LAN connector	For external control by communication commands or web browsers
⑨	RS-232C connector	3-pin captive screw connector for RS-232C serial control
⑩	ALARM connector	Outputs an alert for abnormalities of power supply unit, cooling fan, internal temperature, board, and audio board status. Connector type is 2-pin captive screw connector.
⑪	Power switch (POWER)	Controls the power.
⑫	Power supply connector	For use with supplied power cable
⑬	Frame ground	Use for bonding chassis to local ground. An M4 screw is used.
⑭	HDMI input connectors	Input connectors for HDMI and DVI signals to interface source devices, such as Blu-ray players and computers.
⑮	HDMI cable fixing holes (Not used)	Not used.
⑯	HDBaseT input connector	Input connector for HDBaseT signals Connects to a transmitter over a category cable.
⑰	3G-SDI input connector	Input connector for 3G-SDI/HD-SDI/SD-SDI signals For 3G-SDI signals, Level A and Level B are supported. Can be extended up to 984 ft. (300 m) (SD-SDI input).
⑱	3G-SDI loop-through output connector	If the FDX-S is powered on, the input SDI signals can be output from the SDI loop-through output connectors.
⑲	HDMI output connectors	Output connectors for HDMI and DVI signals, interfaces sink devices such as LC monitors and projectors
⑳	HDBaseT output connectors	Output connector for HDBaseT signal Connects to a receiver over a category cable.
㉑	Analog audio output connector	Output connectors (3-pin captive screw connector) for analog audio signals
㉒	Power supply unit (Primary)	Primary power supply unit for redundant power supply
㉓	Power supply unit (Secondary)	Secondary power supply unit for redundant power supply
㉔	Fan unit	Replaceable fan unit
<b>Side panel</b>		
㉕	Ventilation holes	Prevents internal temperature from rising. Do not block ventilation holes.

### 5.1.3 FDX-S32U

● Front panel

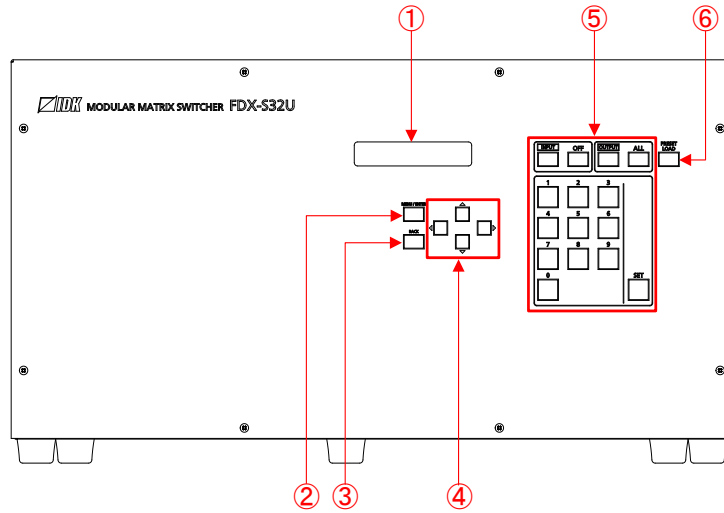

● Rear panels

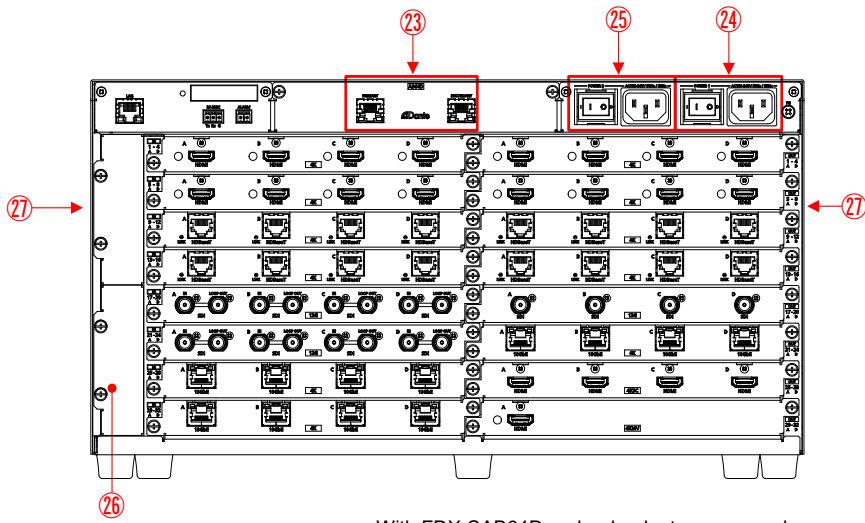
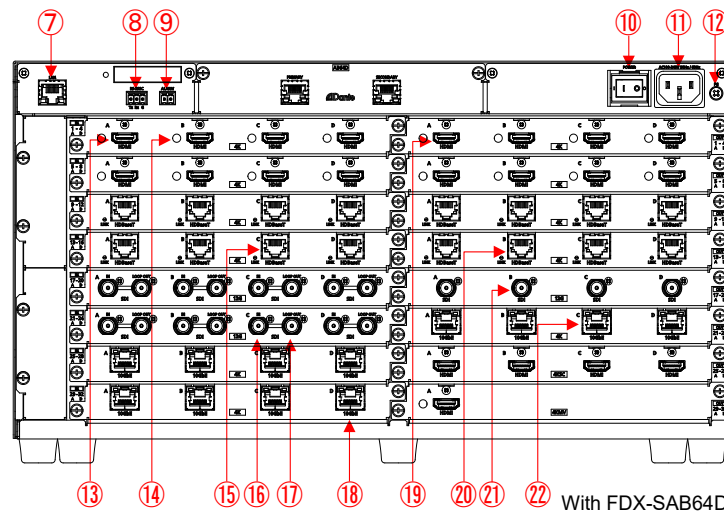

With FDX-SAB64D and redundant power supply

[Fig. 5.3] Drawings

**[Table 5.3] Features**

[1/2]

#	Feature	Description														
<b>Front panel</b>																
①	Front display	Displays menus and settings.														
②	MENU/ENTER button	Selects menus, edits, controls, and saves settings.														
③	BACK button	Available only in menu pages. Goes back to the previous page.														
④	Navigation buttons	Navigates menu or changes values of adjustable features.														
⑤	I/O channel selection buttons	<table border="1"> <thead> <tr> <th>Buttons</th> <th>Description</th> </tr> </thead> <tbody> <tr> <td>Numeric buttons (0 to 9)</td> <td>Enters number. Selects the preset memory number (in loading preset mode).</td> </tr> <tr> <td>SET</td> <td>Applies settings.</td> </tr> <tr> <td>INPUT</td> <td>Specifies input channel.</td> </tr> <tr> <td>OFF</td> <td>Does not output video.</td> </tr> <tr> <td>OUTPUT</td> <td>Specifies output channel.</td> </tr> <tr> <td>ALL</td> <td>Selects all output channels.</td> </tr> </tbody> </table>	Buttons	Description	Numeric buttons (0 to 9)	Enters number. Selects the preset memory number (in loading preset mode).	SET	Applies settings.	INPUT	Specifies input channel.	OFF	Does not output video.	OUTPUT	Specifies output channel.	ALL	Selects all output channels.
Buttons	Description															
Numeric buttons (0 to 9)	Enters number. Selects the preset memory number (in loading preset mode).															
SET	Applies settings.															
INPUT	Specifies input channel.															
OFF	Does not output video.															
OUTPUT	Specifies output channel.															
ALL	Selects all output channels.															
⑥	PRESET LOAD button	Enables preset memory load mode.														
<b>Rear panels</b>																
⑦	LAN connector	For external control by communication commands or web browsers														
⑧	RS-232C connector	3-pin captive screw connector for RS-232C serial control														
⑨	ALARM connector	Outputs an alert for abnormalities of power supply unit, cooling fan, internal temperature, board, and audio board status. Connector type is 2-pin captive screw connector.														
⑩	Power switch (POWER)	Controls the power.														
⑪	Power supply connector	For use with supplied power cable														
⑫	Frame ground	Use for bonding chassis to local ground. An M4 screw is used.														
⑬	HDMI input connectors	Input connectors for HDMI and DVI signals to interface source devices, such as Blu-ray players and computers.														
⑭	HDMI cable fixing holes (Not used)	Not used.														
⑮	HDBaseT input connector	Input connector for HDBaseT signals Connects to a transmitter over a category cable.														
⑯	12G-SDI input connector	Input connector for 12G-SDI/6G-SDI/3G-SDI/HD-SDI signals For 3G-SDI signals, only Level A is supported. Multi link signal can be input. Can be extended up to 787 ft. (240 m) (HD-SDI input).														

#	Feature	Description
<b>Rear panels</b>		
⑰	12G-SDI loop-through output connector	If the FDX-S is powered on, the input SDI signals can be output from the SDI loop-through output connectors.
⑱	10GbE input connector	Input connector for SDVoE signal Connects to IDK's SDVoE supported product over a category cable.
⑲	HDMI output connectors	Output connectors for HDMI and DVI signals, interfaces sink devices such as LC monitors and projectors
⑳	HDBaseT output connectors	Output connector for HDBaseT signal Connects to a receiver over a category cable.
㉑	12G-SDI output connector	Output connector for 12G-SDI/6G-SDI/3G-SDI/HD-SDI signals For 3G-SDI signals, only Level A is supported. Multi link signal can be output.
㉒	10GbE output connector	Output connector for SDVoE signal Connects to IDK's SDVoE supported product over a category cable.
㉓	Dante connectors	I/O connector for network audio (Dante format) Connects to IP network.
㉔	Power supply unit (Primary)	Primary power supply unit for redundant power supply
㉕	Power supply unit (Secondary)	Secondary power supply unit for redundant power supply
㉖	Fan unit	Replaceable fan unit
<b>Side panel</b>		
㉗	Ventilation holes	Prevents internal temperature from raising. Do not block ventilation holes.

### 5.1.4 FDX-S64U

● Front panel

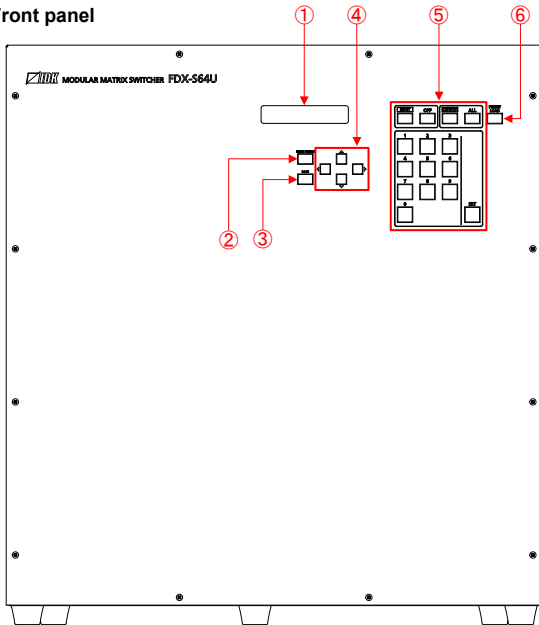

● Rear panels

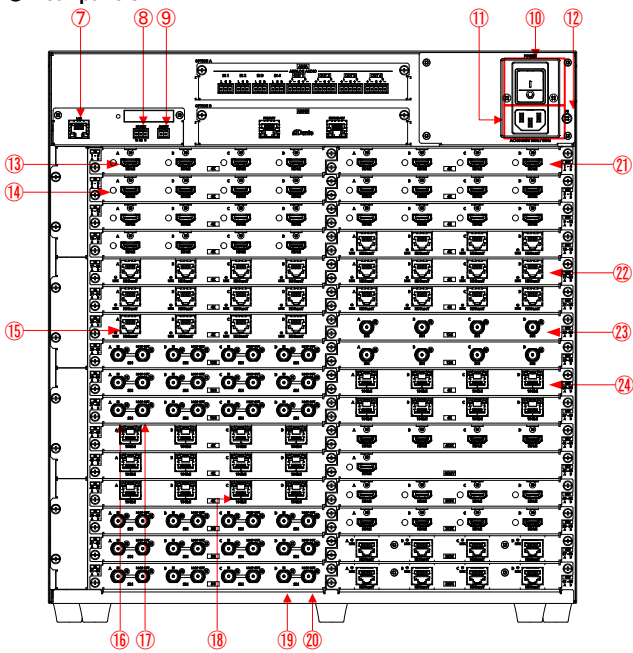

With FDX-SAB4A and FDX-SAB64D

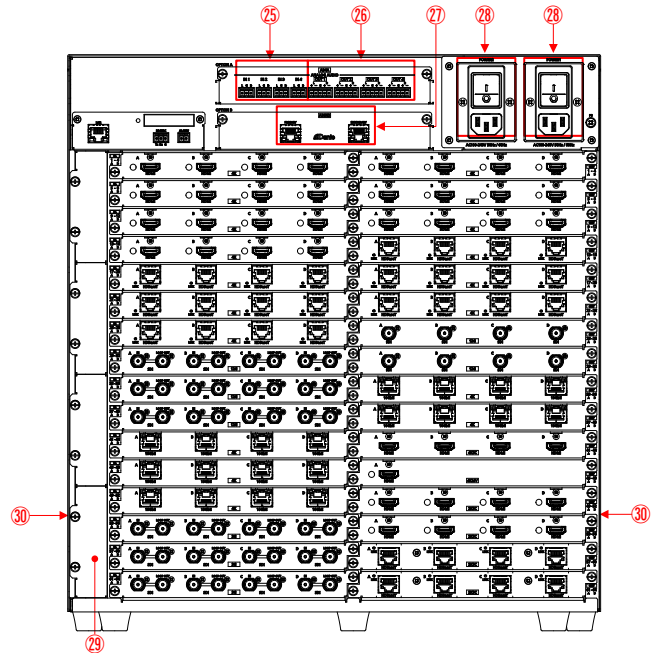

With FDX-SAB4A, FDX-SAB64D, and redundant power supply

[Fig. 5.4] Drawings

[Table 5.4] Features

[1/2]







#	Feature	Description														
<b>Front panel</b>																
①	Front display	Displays menus and settings.														
②	MENU/ENTER button	Selects menus, edits, controls, and saves settings.														
③	BACK button	Available only in menu pages. Goes back to the previous page.														
④	Navigation buttons	Navigates menu or changes values of adjustable features.														
⑤	I/O channel selection buttons	<table border="1"> <thead> <tr> <th>Buttons</th> <th>Description</th> </tr> </thead> <tbody> <tr> <td>Numeric buttons (0 to 9)</td> <td>Enters number. Selects the preset memory number (in loading preset mode).</td> </tr> <tr> <td>SET</td> <td>Applies settings.</td> </tr> <tr> <td>INPUT</td> <td>Specifies input channel.</td> </tr> <tr> <td>OFF</td> <td>Does not output video.</td> </tr> <tr> <td>OUTPUT</td> <td>Specifies output channel.</td> </tr> <tr> <td>ALL</td> <td>Selects all output channels.</td> </tr> </tbody> </table>	Buttons	Description	Numeric buttons (0 to 9)	Enters number. Selects the preset memory number (in loading preset mode).	SET	Applies settings.	INPUT	Specifies input channel.	OFF	Does not output video.	OUTPUT	Specifies output channel.	ALL	Selects all output channels.
		Buttons	Description													
		Numeric buttons (0 to 9)	Enters number. Selects the preset memory number (in loading preset mode).													
		SET	Applies settings.													
		INPUT	Specifies input channel.													
		OFF	Does not output video.													
		OUTPUT	Specifies output channel.													
ALL	Selects all output channels.															
⑥	PRESET LOAD button	Enables preset memory load mode.														
<b>Rear panels</b>																
⑦	LAN connector	For external control by communication commands or web browsers														
⑧	RS-232C connector	3-pin captive screw connector for RS-232C serial control														
⑨	ALARM connector	Outputs an alert for abnormalities of power supply unit, cooling fan, internal temperature, board, and audio board status. Connector type is 2-pin captive screw connector.														
⑩	Power switch (POWER)	Controls the power.														
⑪	Power supply connector	For use with supplied power cable														
⑫	Frame ground	Use for bonding chassis to local ground. An M4 screw is used.														
⑬	HDMI input connectors	Input connectors for HDMI and DVI signals to interface source devices, such as Blu-ray players and computers.														
⑭	HDMI cable fixing holes (Not used)	Not used.														
⑮	HDBaseT input connector	Input connector for HDBaseT signals. Connects to a transmitter over a category cable.														
⑯	12G-SDI input connector	Input connector for 6G-SDI/3G-SDI/HD-SDI signals. For 3G-SDI signals, only Level A is supported. Can be extended up to 787 ft. (240 m) (HD-SDI input).														

#	Feature	Description
<b>Rear panels</b>		
⑰	12G-SDI loop-through output connector	If the FDX-S is powered on, the input SDI signals can be output from the SDI loop-through output connectors.
⑱	10GbE input connector	Input connector for SDVoE signal Connects to IDK's SDVoE supported product over a category cable.
⑲	3G-SDI input connector	Input connector for 3G-SDI/HD-SDI/SD-SDI signals. For 3G-SDI signals, Level A and Level B are supported. Can be extended up to 984 ft. (300 m) (SD-SDI input).
⑳	3G-SDI loop-through output connector	If the FDX-S is powered on, the input SDI signals can be output from the SDI loop-through output connectors.
㉑	HDMI output connectors	Output connectors for HDMI and DVI signals, interfaces sink devices such as LC monitors and projectors
㉒	HDBaseT output connectors	Output connector for HDBaseT signal Connects to a receiver over a category cable.
㉓	12G-SDI output connector	Output connector for 12G-SDI/6G-SDI/3G-SDI/HD-SDI signals For 3G-SDI signals, only Level A is supported. Gearbox is supported.
㉔	10GbE output connector	Output connector for SDVoE signal Connects to IDK's SDVoE supported product over a category cable.
㉕	Analog audio input connector	Input connectors (3-pin captive screw connector) for analog audio signals
㉖	Analog audio output connector	Output connectors (5-pin captive screw connector) for analog audio signals
㉗	Dante connectors	I/O connector for network audio (Dante format) Connects to IP network.
㉘	Power supply unit (Primary)	Primary power supply unit for redundant power supply
㉙	Power supply unit (Secondary)	Secondary power supply unit for redundant power supply
㉚	Fan unit	Replaceable fan unit
<b>Side panel</b>		
㉛	Ventilation holes	Prevents internal temperature from raising. Do not block ventilation holes.

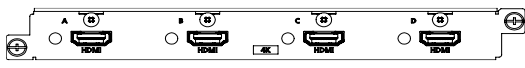
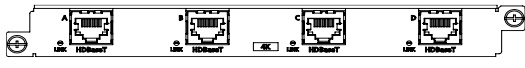
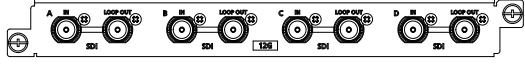
## 5.2 I/O boards

An input board cannot be installed to the output side and vice versa.

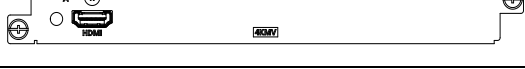
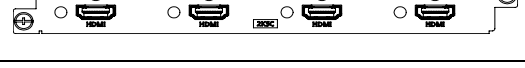

[Table 5.5] Boards for FDX-S

P/N	Input/ Output	Description	Drawings
FDX-SIV4UH	Input	4K@60 HDMI/DVI	
FDX-SOV4UH	Output		
FDX-SIV4UT	Input	4K@60 HDBaseT	
FDX-SOV4UT	Output		
FDX-SIV4US	Input	12G-SDI/6G-SDI/3G-SDI/HD-SDI	
FDX-SIV4UC	Input	4K@60 SDVoE	
FDX-SOV4UC	Output		
FDX-SOV4US	Output	12G-SDI/6G-SDI/3G-SDI/HD-SDI	
FDX-SOV4UHS	Output	4K@60 HDMI/DVI scan converter	
FDX-SOV2UHS	出力	4K@60 HDMI / DVI Scan converter	
FDX-SOV1UHM	Output	4K@60 HDMI/DVI scan converter multiview	
FDX-SOV4HS	Output	1080p HDMI/DVI scan converter	
FDX-SOV4TS	Output	1080p HDBaseT scan converter	
FDX-SIV4S	Input	3G-SDI/HD-SDI/SD-SDI	

### 5.3 Audio board

Up to two audio boards can be installed to the FDX-S64U.

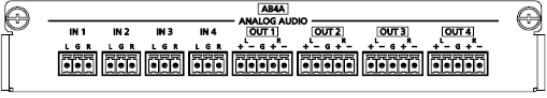
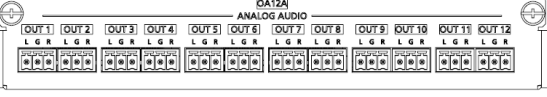
[Table 5.6] Audio boards for FDX-S

P/N	Input/Output	Description	Drawings
FDX-SAB4A	Input	4-input analog audio Unbalanced Stereo LR	
	Output	4-output analog audio Balanced/Unbalanced Stereo LR	
FDX-SOA12A	Output	12-output analog audio Unbalanced Stereo LR	
FDX-SAB64D	Input	1-input network audio 64 Dante* channels (32 stereo channels)	
	Output	1-input network audio 64 Dante* channels (32 stereo channels)	

\*See "9.4 Dante" for details of Dante.

### 5.4 Redundant power supply unit

■ Redundant power supply units

[Table 5.7] Redundant power supply units

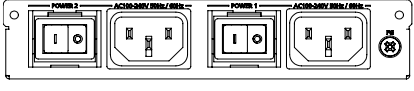
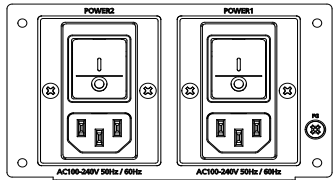
P/N	For	Drawing
FDX-SRP08	FDX-S08U	
FDX-SRP16	FDX-S16U	
FDX-SRP32	FDX-S32U	
FDX-SRP64	FDX-S64U	

## 6 System Configuration Example

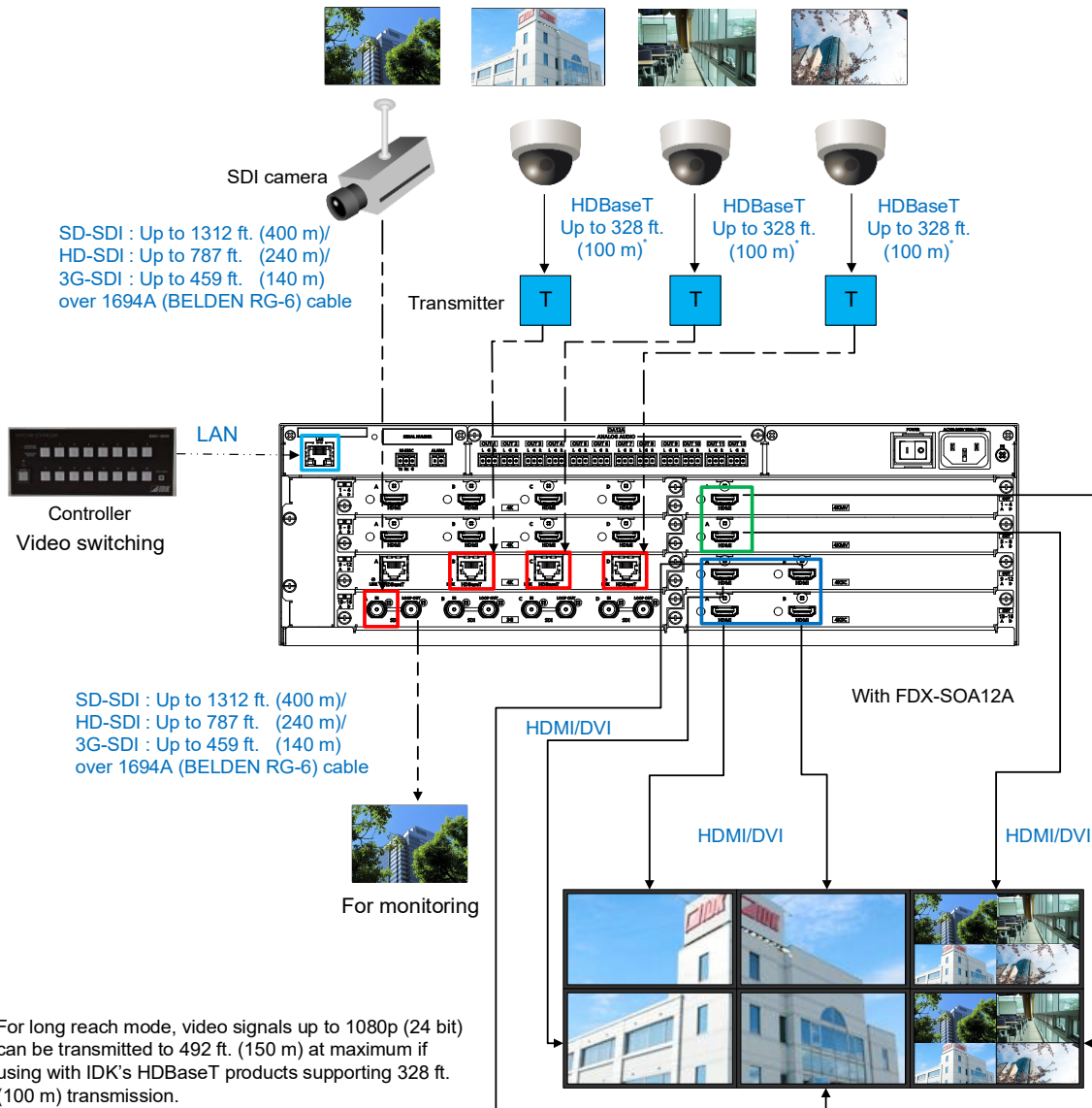

[Fig. 6.1] System configuration example (Example: FDX-S16U)

## 7 Installation

### 7.1 Precautions

When installing the FDX-S, observe the following precautions; otherwise, the internal temperature might increase and it may affect the product lifetime and operation.

- Do not stack or place one FDX-S directly on top of another FDX-S.
- Do not block vent holes.
- To provide adequate ventilation, maintain sufficient clearances around the FDX-S (1.2 in. (30 mm) or more).
- Consider installing the FDX-S in an environment compatible with the maximum temperature indicated in the specification sheet 32°F to 104°F (0°C to +40°C).

### 7.2 Rack mounting brackets

Attach the rack mounting brackets to the FDX-S chassis using the supplied M4 screws.

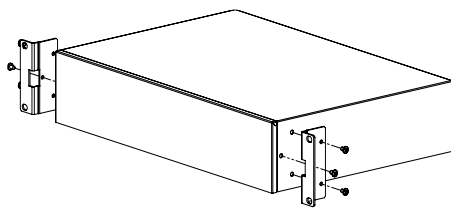

For FDX-S08U

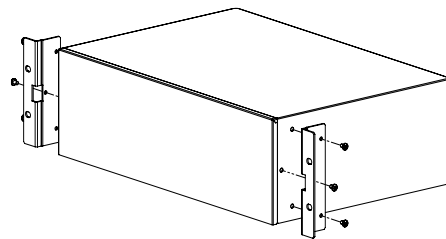

For FDX-S16U

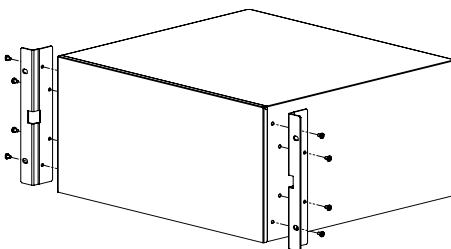

For FDX-S32U

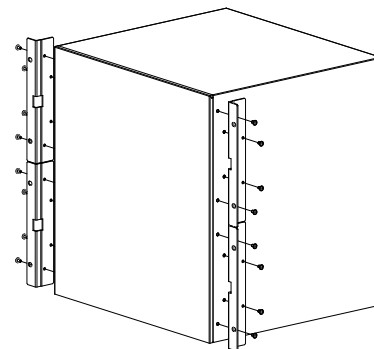

For FDX-S64U

[Fig. 7.1] Attaching rack mounting brackets

**Note:**

The standard screw tightening torque is 1.47 N·m (about 15.0 kgf·cm).

## 8 Connection Details

### 8.1 Precautions

When connecting the FDX-S to external devices, observe the following precautions.

- Read the manuals for all external devices.
- Before connecting cables to the FDX-S or an external device, dissipate static electricity by touching grounded metal such as equipment racks before handling signal cables. Failure to observe this precaution may result in ESD (electrostatic discharge) damage.
- Power all units off before connecting cables.
- Be sure to fully seat all plugs and connections and dress cables to reduce stress on connectors.

### 8.2 Connecting video devices

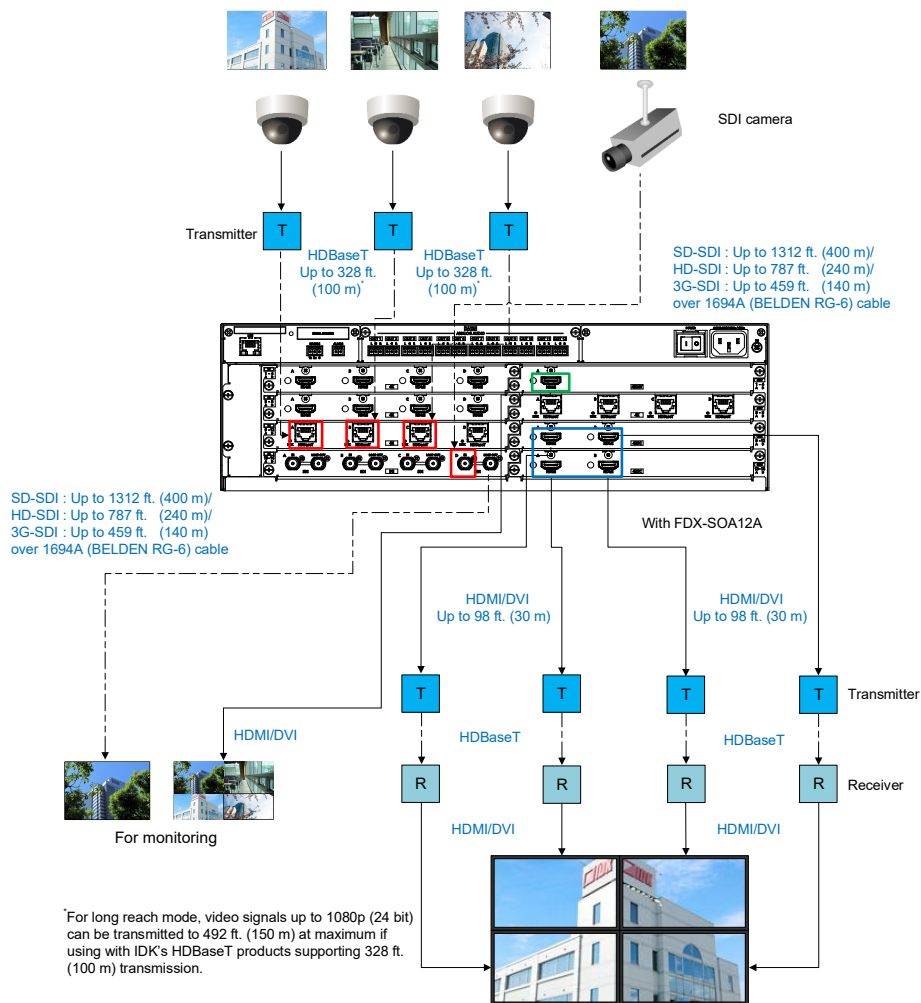

[Fig. 8.1] Connecting video devices (Example: FDX-S08U)

## 8.2.1 HDMI cable

When the video is 4K format, the maximum TMDS data rate (transmission speed) is 18 Gbps. If a high-speed HDMI cable is used, the maximum TMDS data rate of 10.2 Gbps can be transferred, and the video cannot be displayed stably.

Please select an 18 Gbps high-speed cable depending on the 4K format. The maximum transmission distance depends on the cable type, source and sink devices. You are recommended to use high quality cables.

[Table 8.1] 18 Gbps high-speed cable for 4 K format

	TMDS data rate (Gbps)								
	RGB, YCbCr 4:4:4			YCbCr 4:2:2			YCbCr 4:2:0		
4K format	24 bit	30 bit	36 bit	24 bit	30 bit	36 bit	24 bit	30 bit	36 bit
3840x2160p (24/25/30)	10.2 Gbps	18 Gbps	18 Gbps	10.2 Gbps	10.2 Gbps	10.2 Gbps	N/A	N/A	N/A
4096x2160 (24/25/30)	10.2 Gbps	18 Gbps	18 Gbps	10.2 Gbps	10.2 Gbps	10.2 Gbps	N/A	N/A	N/A
3840x2160p (50/59.94/60)	18 Gbps	N/A	N/A	18 Gbps	18 Gbps	18 Gbps	10.2 Gbps	18 Gbps	18 Gbps
4096x2160 (50/59.94/60)	18 Gbps	N/A	N/A	18 Gbps	18 Gbps	18 Gbps	10.2 Gbps	18 Gbps	18 Gbps

18 Gbps: 18 Gbps high-speed cable; 10.2 Gbps: 10.2 Gbps cable

### Note:

If a cable is extended and a cable joint (JJ) is used, video may be interrupted or may not be output.

## 8.2.2 Cable Lacing Bracket

Use the cable lacing bracket to secure a standard HDMI cable as shown.

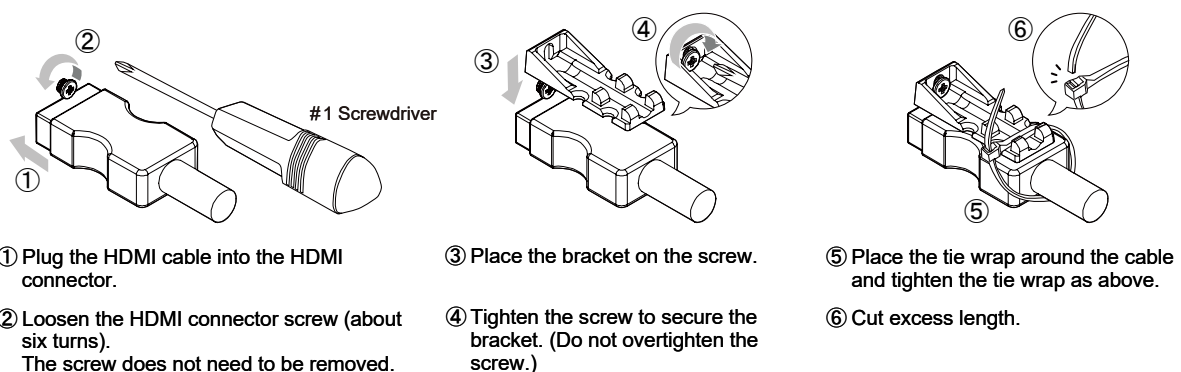

[Fig. 8.2] Cable Lacing Bracket (FB-01 For IDK products only)

## 8.2.3 HDBaseT input and output connectors

---

Both HDBaseT input and output connector support long reach mode.

With long reach mode, video signals up to 1080p (24 bit) can be transmitted to 492 ft. (150 m) at maximum if using with IDK's HDBaseT products supporting 328 ft. (100 m) transmission.

Enable the HDBaseT Long reach mode from following menus:

### For HDBaseT input

- 10.7.3 HDBaseT input long reach mode
- 10.12.1 Resolution
- 10.12.6 Deep Color

### For HDBaseT output

- 10.4.1 Output resolution
- 10.5.7 HDBaseT output long reach mode
- 10.5.8 Deep Color output

## 8.2.4 Category cable

To ensure the best performance with category cables, select a high quality category cable type, ensuring that proper pinning and pairing requirements are observed.

- Cat5e UTP/STP and Cat6 UTP/STP can be used, but we recommend CAT.5E HDC cable\* for optimal performance.
- If using STP cables, connect the FG connector to a local electrical ground bonding point. Without bonding FG to ground, the shielding feature may not effectively eliminate interference. If using UTP cables, it is still recommended that the FG connector be used.
- STP cables are less affected by interference or external noise than UTP cables.
- Connectors for long-haul transmission are the same as that of the eight-core modular connector used for Ethernet, but the transmission system is not the same so it cannot be connected to Ethernet.
- The maximum transmission distance of a category cables is the shorter distance of the maximum transmission distances of transmitter/receiver/sink device connected to the FDX-S.
- Pin assignments: T568A or T568B straight
- Do not pull the cable using excessive force.
- Do not bend the cable at a sharp angle. Keep the bend radius four times of the cable diameter or larger.
- Do not clamp or tie the cable tightly; leave some space allowing the cable to move slightly.
- If you use multiple category cables, keep a distance between the cables or not to place the cables closely in parallel.
- Keep the category cable running as straight as possible. Looping or coiling the cable causes it to be more easily affected by noise; especially when using longer cable run lengths.
- Do not place the cable in an electrically noisy environment, since high-speed impulsive noise may couple into the category cable. Use of a high-output radio transmission device near the FDX-S or remote receivers may interfere with or interrupt video and or audio signals.
- If the total transmission distance from the transmitter to receiver is 328 ft. (100 m) or less, up to two cable interconnection points can be used. Cable joint supporting Cat6A (10GBase-T) are recommended. For high resolution, such as 4K, video transmission distance may be shortened by about 10%.
- The table below shows supported transmission distance for each category.  
If signals are transmitted for a long haul or with noise from other devices, use a broadband cable or cable that has high shielding performance.

Note that specified distances may shorten depending on the conditions within the actual environment.

**[Table 8.2] Transmission distance**

Noise influence	Category		Transmission distance	TMDS clock	Recommended cable
Easily affected	UTP	Cat5e	164 ft. (50 m)	$\leq$ 225 MHz	For 164 ft. (50 m) or longer: CAT.5E HDC, Cat5e STP, and Cat6 UTP/STP cables
		Cat6	328 ft. (100 m)		
				230 ft. (70 m)	
Easily affected	STP	Cat5e*	328 ft. (100 m)	Long reach mode $\leq$ 148 MHz (1080p (24 bit) or less)	For 4K format 230 ft. (70 m) or longer: CAT.5E HDC, Cat5e STP, and Cat6 STP cables
		Cat6	492 ft. (150 m)		

- \* The CAT.5E HDC cable is a double-shielded category cable optimized for video signal transmission. The double-shielded structure protects the video signal from external interference. It supports 500 MHz bandwidth at distances up to 328 ft. (100 m).

## 8.2.5 Category cable for SDVoE

---

To ensure the best performance with category cables, select a high quality category cable type, ensuring that proper pinning and pairing requirements are observed.

- CAT.5E HDC cable is recommended.
- If using STP cables, connect the FG connector to a local electrical ground bonding point. Without bonding FG to ground, the shielding feature may not effectively eliminate interference. If using UTP cables, it is still recommended that the FG connector be used.
- STP cables are less affected by interference or external noise than UTP cables.
- Pin assignments: T568A or T568B straight
- Do not pull the cable using excessive force (allowable cable tension: 110 N or less).
- Do not bend the cable at a sharp angle. Keep the bend radius four times of the cable diameter or larger.
- Do not clamp or tie the cable tightly; leave some space allowing the cable to move slightly.
- If you use multiple category cables, keep a distance between the cables or not to place the cables closely in parallel.
- Keep the category cable running as straight as possible. Looping or coiling the cable causes it to be more easily affected by noise; especially when using longer cable run lengths.
- Do not place the cable in an electrically noisy environment, since high-speed impulsive noise may couple into the category cable. Use of a high-output radio transmission device near the FDX-S or remote receivers may interfere with or interrupt video and or audio signals.

## 8.2.6 Coaxial cable

---

Select the appropriate coaxial cable by referring to the following table.

**[Table 8.3] Maximum transmission distances when using BELDEN cable**

SDI type	Cable	Max. transmission distances	
		FDX-SIV4US/FDX-SOV4US	FDX-SIV4S
12G-SDI	1694A (BELDEN RG-6)	197 ft. (60 m)	-
6G-SDI	1694A (BELDEN RG-6)	262 ft. (80 m)	-
3G-SDI	1505A (BELDEN RG-59)	5.1 ft. (130 m)	394 ft. (120 m)
	1694A (BELDEN RG-6)	525 ft. (160 m)	459 ft. (140 m)
HD-SDI	1505A (BELDEN RG-59)	7.9 ft. (200 m)	656 ft. (200 m)
	1694A (BELDEN RG-6)	820 ft. (250 m)	787 ft. (240 m)
SD-SDI	1505A (BELDEN RG-59)	-	1083 ft. (330 m)
	1694A (BELDEN RG-6)	-	1312 ft. (400 m)

**Note:**

Maximum transmission distance depends on the characteristics of each source device and quality of each cable.

## 8.3 Connecting control devices

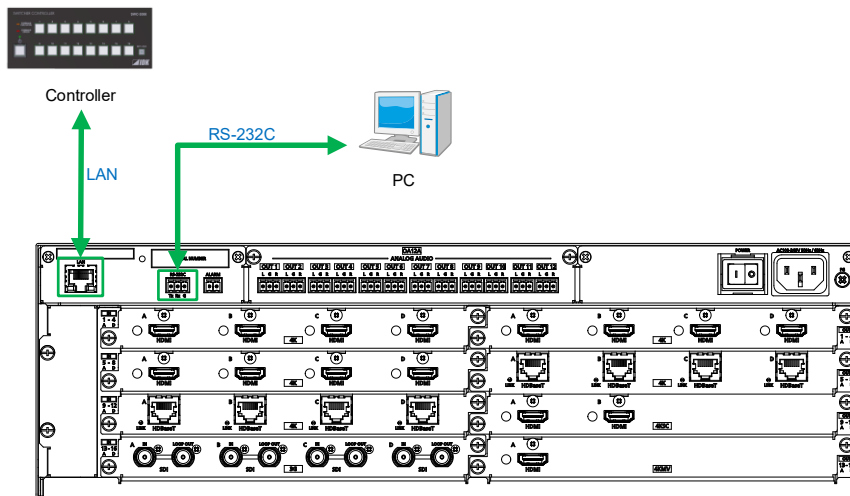

With FDX-SOA12A

[Fig. 8.3] Application example for control devices (Example: FDX-S16U)

### 8.3.1 RS-232C communication

Set RS-232C communication in “10.13.1 RS-232C communication”.

Since the FDX-S supports RS-232C transmission from HDBaseT/SDVoE I/O boards, source and sink devices that are connected to FDX-S HDBaseT/SDVoE I/O connectors via HDC series can be controlled.

#### ■ Connecting RS-232C cable

The FDX-S’s RS-232C connection is supported by a 3-pin captive screw connector.

Insert and secure the wires from the RS-232C cable into the supplied 3-pin captive screw connector, and then insert the captive screw connector into the mating connector on the FDX-S.

24 AWG to 16 AWG conductor gauge is recommended.

The recommended wire strip length is 0.28 in. (7 mm).

Short RTS/CTS and DTR/DSR as needed.

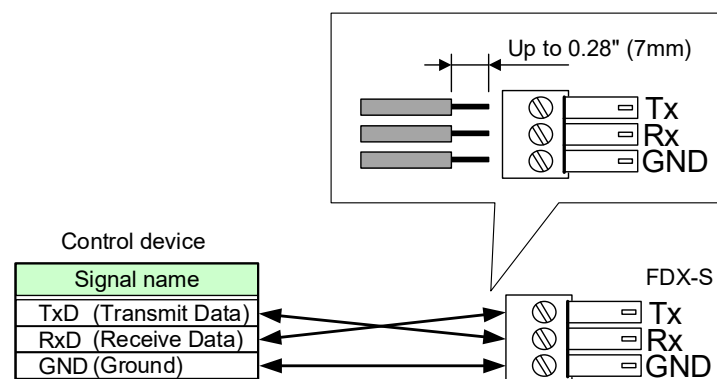

[Fig. 8.4] Connecting RS-232C cable to 3-pin captive screw connector

## 8.3.2 LAN communication

---

The FDX-S includes the function that is equivalent to those of switching hub. It enables LAN communication between the LAN connectors of the FDX-S and the HDC series that are connected to the HDBaseT/SDVoE I/O connector.

【See: 10.14.6 Output LAN of extension connector】

【See: 10.14.7 Input LAN of extension connector】

### Notes:

#### ■ LAN loop problem

If the HDBaseT/SDVoE I/O connector LAN function is enabled and products including a switching hub are connected to FDX-S HDBaseT connectors, the network may be down due to loop problem. In case the loop problem occurs, check the LAN setting and LAN connection.

#### ■ DHCP

The FDX-S does not support automatic acquisition of IP address using DHCP (Dynamic Host Configuration Protocol).

## 8.3.3 Alarm

---

Connect the provided 2-pin captive screw connector to the "ALARM" connector in order to detect problems in the power supply voltage, cooling fans, internal temperature, board, and audio board.

24 AWG to 16 AWG conductor gauge is recommended.

The recommended wire strip length is 0.28 in. (7 mm).

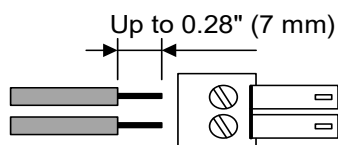

**[Fig. 8.5] Connecting cable to 2-pin captive screw connector**

## 8.4 Connecting audio devices

See “9.4 Dante” for details of Dante network connection.

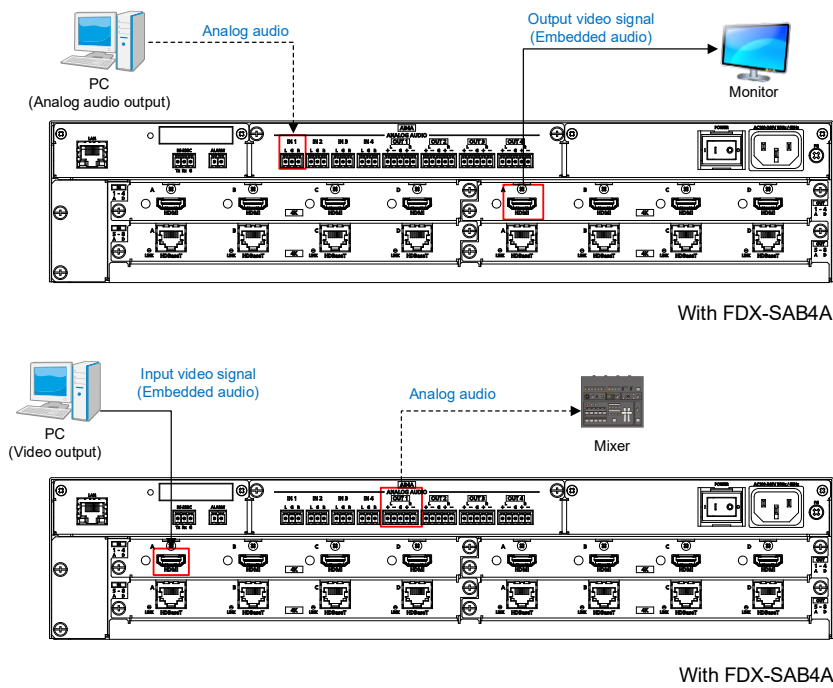

[Fig. 8.6] Connecting audio devices (Example: Installing FDX-SAB4A to FDX-S08U)

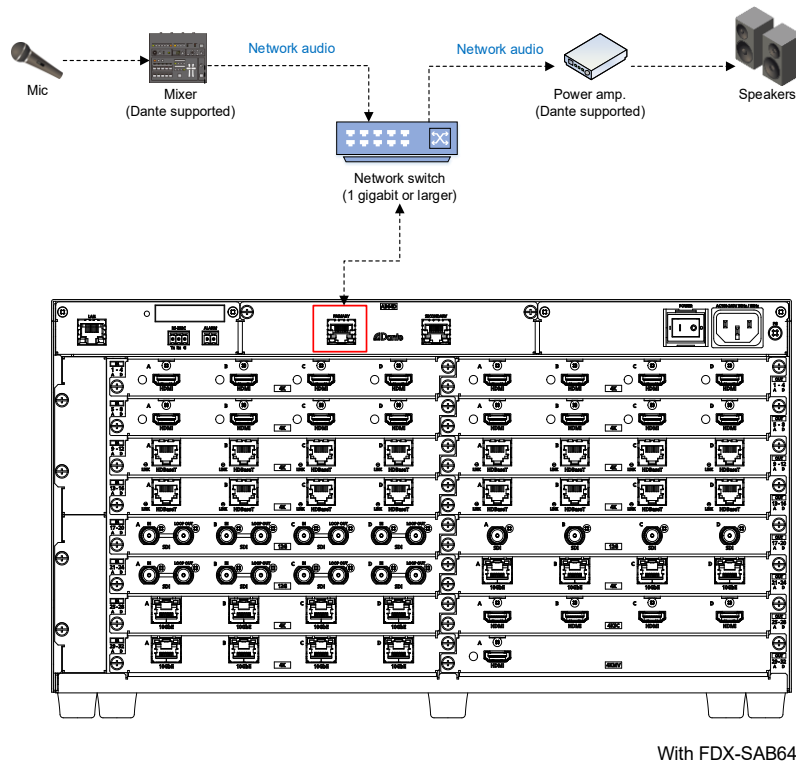

[Fig. 8.7] Connecting audio devices (Example: Installing FDX-SAB64D to FDX-S32U)

**Note:**

Audio cannot be transmitted from input to output in an audio board.

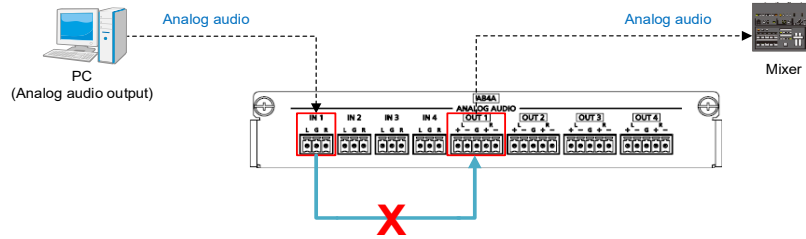

**[Fig. 8.8] Audio cannot be transmitted from input to output in an audio board**

Two audio boards can be installed to the FDX-S64U, but audio cannot be transmitted between an installed audio boards.

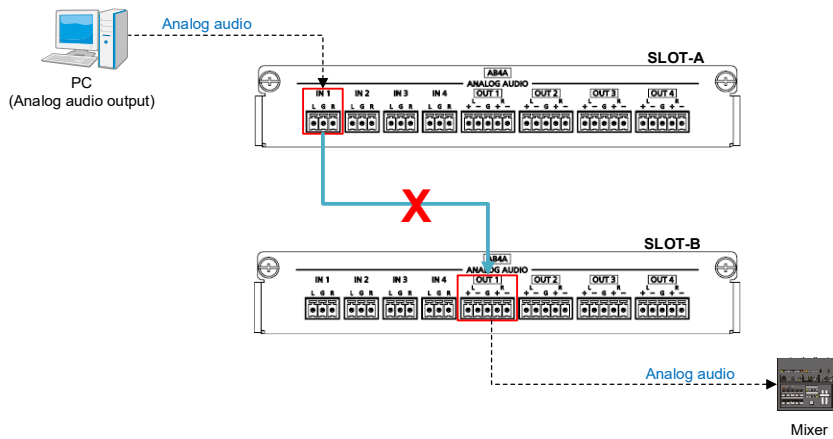

**[Fig. 8.9] Audio cannot be transmitted between an audio boards between installed audio boards**

### 8.4.1 Analog audio connector

Connect the supplied 3-pin/5-pin captive screw connector to the FDX-S.

3-pin captive screw connector supports unbalanced signal.

5-pin captive screw connector supports both balanced and unbalanced signal.

24 AWG to 16 AWG conductor gauge and a strip length of 0.28 in. (7 mm) are recommended.

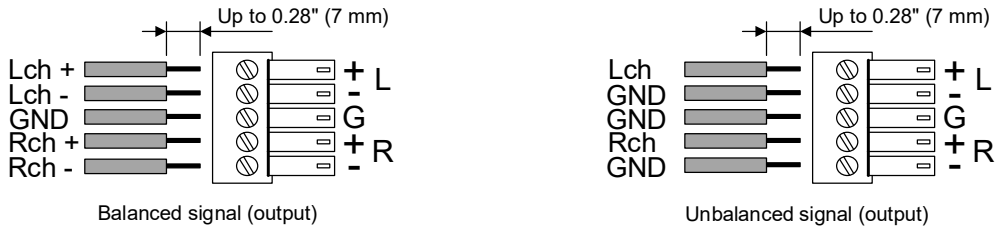

[Fig. 8.10] Connecting audio cable to 5-pin captive screw connector

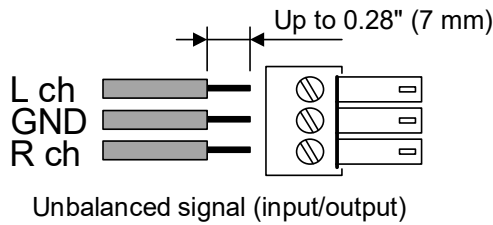

[Fig. 8.11] Connecting audio cable to 3-pin captive screw connector

### 8.5 Connecting power cord

For redundant power supply, connect power cords to “POWER 1” and “POWER 2”.

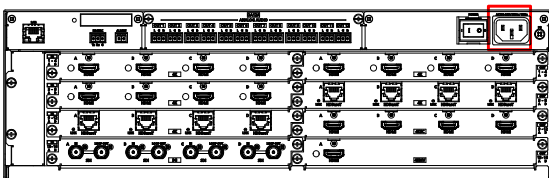

With FDX-SOA12A

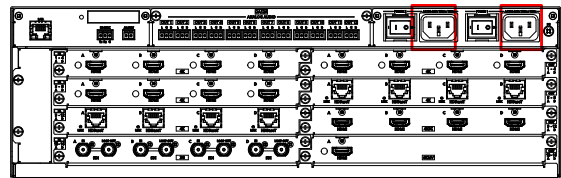

With FDX-SOA12A and redundant power supply

[Fig. 8.12] Connecting power cord

## 9 Operation

### 9.1 Powering on/off

Turn on the “POWER” switch of the rear panel to power on the FDX-S.

If rebooting the FDX-S, wait three seconds or longer after powering off the FDX-S.

For redundant power supply unit, turn on one of “POWER 1” and “POWER 2” switches and then turn on the other switch within five seconds. If turning on the other switch after six seconds past, it is detected as an alarm and the front display flashes. To stop the alarm, power on both of “POWER 1” and “POWER 2” switches.

To shut down the FDX-S, turn off both switches within five seconds.

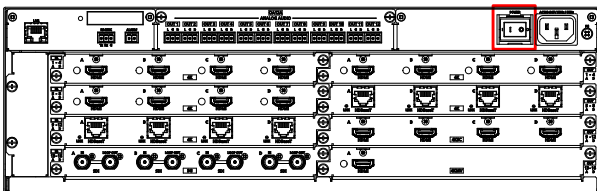

With FDX-SOA12A

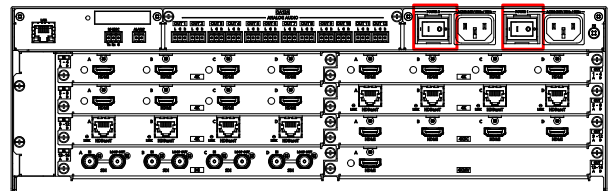

With FDX-SOA12A and redundant power supply

After powering on the FDX-S, there is a short initialization delay before the first communication command can be received and executed.

**[Table 9.1] Power up period**

Operation	Delay period
Receiving front panel operation	15 seconds or longer
Control from WEB browser	15 seconds or longer
Receiving communication command	15 seconds or longer

## 9.2 Front panel operations

### 9.2.1 Selecting menu

**To select a menu:**

1. Press the “MENU/ENTER” button.
2. Select the desired menu using “arrow” buttons.
3. Press the “MENU/ENTER” button again to proceed to the following hierarchy.

For some menus, if the LED flashes. You need to press the “MENU/ENTER” button to apply settings.

Illuminated buttons can be selected.

- “MENU/ENTER” button : Displays menu on the front display.
- “Arrow” buttons (▲ · ▼ · ◀, and ▶) : Navigates menu.
- “BACK” button : Returns to the previous hierarchy.

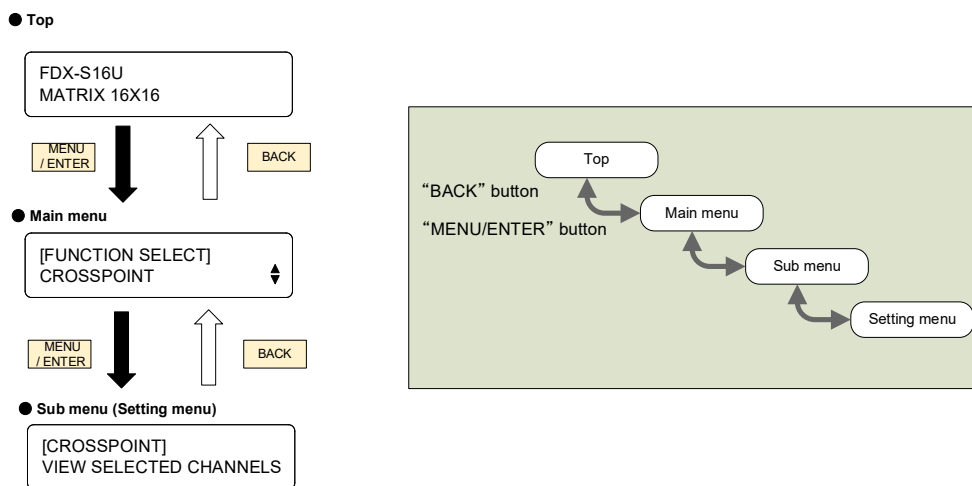

**Notes:**

- The FDX-S menu consists of setting menus and advanced setting menus. 【See: 10.2 Menu】
- The valid input/output channels depend on the output boards installed. 【See: 10.1 Board channel configuration】
- To avoid losing settings, do not interrupt power to the FDX-S while “NOW UPDATE” or “Saving” is displayed; otherwise, the setting information may be lost.

## 9.2.2 Selecting output video

FDX-S08U  
FDX-S16U

To output video by selecting an output channel from an input channel or vice versa:

1. Set [ADVANCED MENU] of [SYSTEM SETTINGS] to [ON].
2. Select "MENU/ENTER" > [FUNCTION SELECT] > [SYSTEM SETTINGS] > [SELECT MODE].
3. Select the desired switching.

For channel selection, "OFF" is set by default.

If no operation is performed for 60 seconds, the FDX-S enters energy-saving mode and the front display goes back to the top page.

【See: 10.18.7 Channel selection mode】

【See: 10.18.5 Power saving】

### ■ [SELECT MODE]: [INPUT] → [OUTPUT]:

Select an input channel and then output channel.

Example: FDX-S16U

Example 1: Displaying IN1 video at OUT3

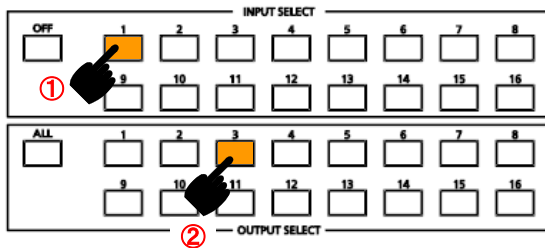

The selected "OUTPUT SELECT" button flashes.

Example 2: Hiding OUT3 video

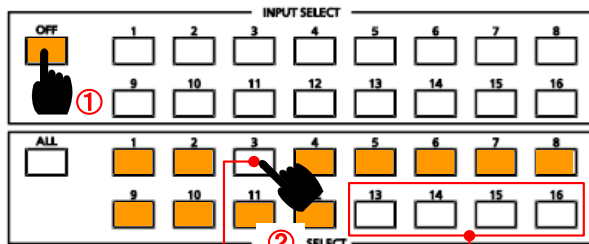

The output channel that does not have output board cannot be selected.

Input channels have been assigned.

No output board is installed.

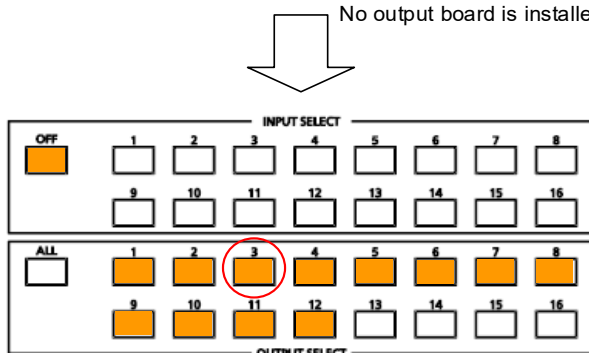

Video that is output from OUT3 is OFF.

■ [SELECT MODE]: [OUTPUT] → [INPUT]

Select an output channel and then input channel.

Example: FDX-S16U

Example 1: Displaying IN1 video to OUT3

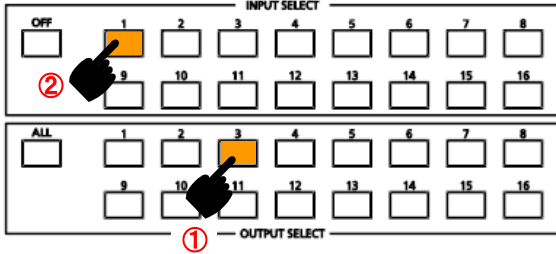

The selected "INPUT SELECT" button flashes.

Example 2: Displaying IN5 video to all output channels

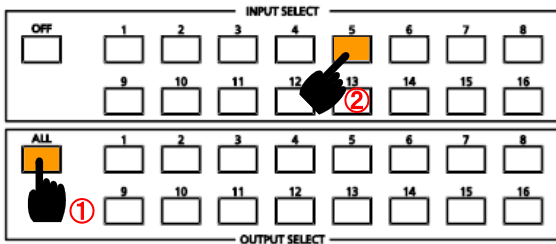

The output channel that does not have board cannot be selected.

Example 3: Hiding video of all output channels

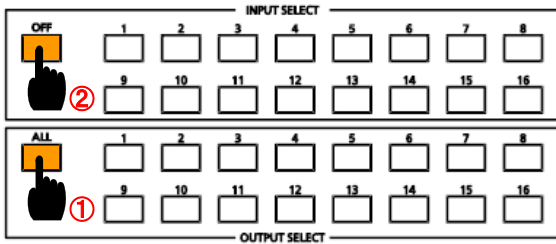

All output channel videos are not displayed.

FDX-S32U  
FDX-S64U

Output video by selecting an output channel from an input channel or vice versa.

For crosspoint, "OFF" is set by default.

If no operation is performed for 10 seconds, the FDX-S becomes in energy-saving mode.

**■ To select channel (Input channel → Output channel):**

Select an input channel and then output channel.

Example 1: Displaying IN1 video at OUT3

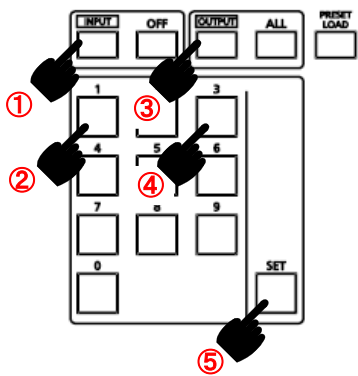

**[Table 9.2] Buttons**

Buttons	Description
Numeric buttons (0 to 9)	Enters numbers.
SET	Applies the setting.
INPUT	Specifies input channel.
OFF	Does not output video.
OUTPUT	Specifies output channel.
ALL	Selects all output channels.

The output channel that does not have board cannot be selected.

Example 2: Hiding OUT9 video

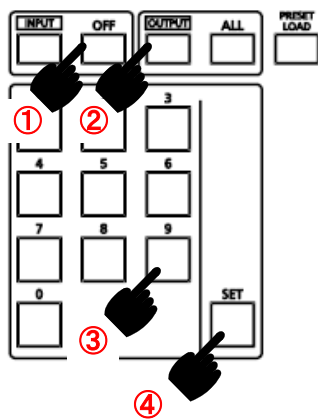

Video that is output from OUT9 is OFF.

■ To select channel (Output channel → Input channel)

Select an output channel and then input channel.

Example 1: Displaying IN9 video to OUT13

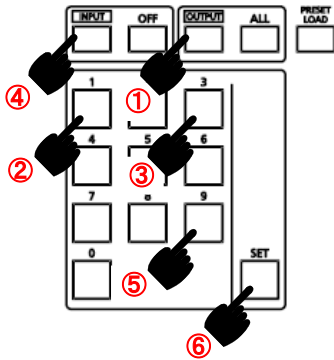

Example 2: Displaying IN5 video to all output channels

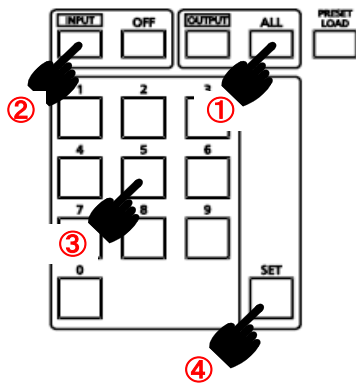

The output channel that does not have board cannot be selected.

Example 3: Hiding video of all output channels

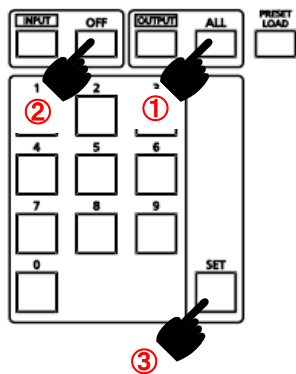

All output channel videos are not displayed.

### 9.2.3 Recalling preset memory

Up to 32 crosspoint configurations can be saved in the preset memory (including crosspoint memory) that can be loaded from the menu.

Part of the FDX-S08U and FDX-S16U preset memories are assigned to “INPUT SELECT” button and can be loaded by operating front buttons.

All FDX-S32U and FDX-S64U preset memories can be loaded by operating front buttons.

If no operation is performed for 60 or 10 seconds (60 seconds for FDX-S08U and FDX-S16U; 10 seconds for FDX-S32U and FDX-S64U), the FDX-S enters in energy-saving mode and the front display goes back to the top page.

【See: 10.18.5 Power saving】

**[Table 9.3] Preset memory loaded from input channel selection and/or I/O channel setting buttons**

P/N	Memory number
FDX-S08U	No.01 to No.08
FDX-S16U	No.01 to No.16
FDX-S32U	No.01 to No.32
FDX-S64U	No.01 to No.32

【See: 10.15 Preset memory】

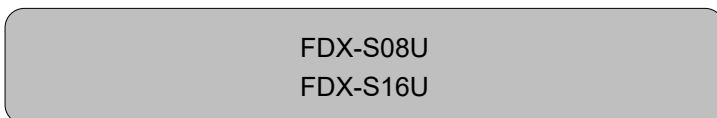

**Example: Loading preset memory No.07**

Example: FDX-S16U

Step 1: Set the mode for loading preset memory.

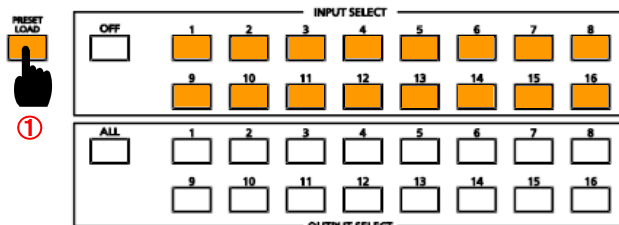

“PRESET LOAD” button. All input channel selection buttons flash.

Step 2: Load a preset memory.

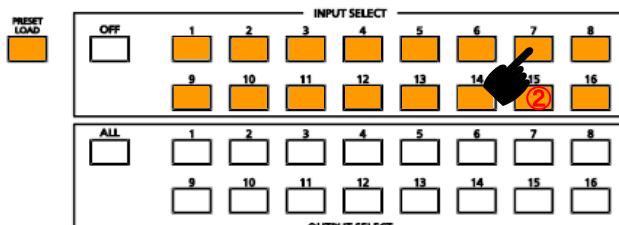

Press “INPUT SELECT 7” button to load preset memory No.07.

Step 3: Escape from the mode.

Press “PRESET LOAD” button.

FDX-S32U  
FDX-S64U

Press the "PRESET LOAD" button and preset memory registration number from "I/O channel selection" buttons (0 to 9).

**Example: Selecting preset memory (No.01)/(No.15)**

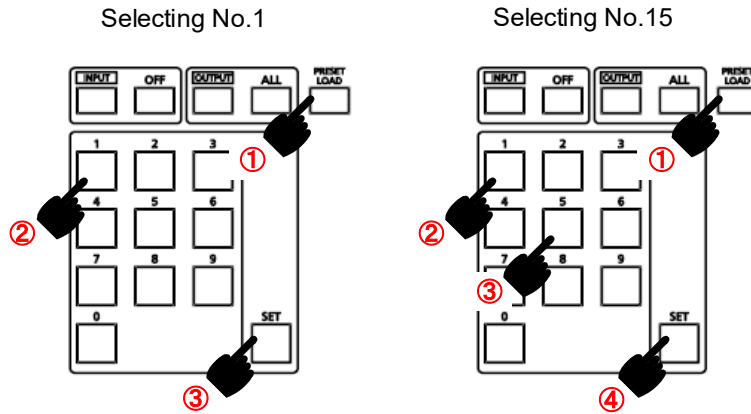

## 9.2.4 Front panel security lockout

The front panel security lockout limits operation of the FDX-S from the front panel to prevent accidental changes.

【See: 10.18.1 Grouping front panel security lockout】

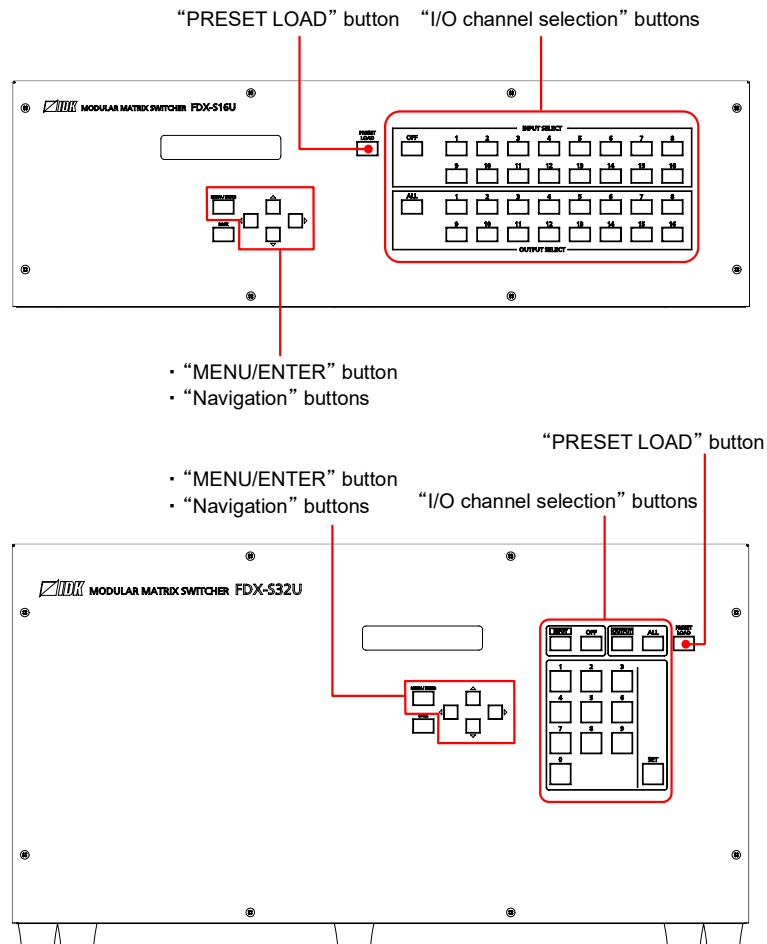

To enable/disable the button security lockout, press and hold the "BACK" button for four seconds or longer. The "MENU/ENTER" button flashes two seconds after pressing and then a message below is displayed on the front display when it is enabled/disabled.

Lockout enabled : BUTTON LOCKED !

Lockout disabled : BUTTON LOCK RELEASED !

## 9.2.5 Initialization

All user configurable settings can be reset to their factory default values except for bitmap memory mode setting by powering the FDX-S on while simultaneously depressing the "BACK" button. Press and hold the "BACK" button until you hear a beep tone.

【See: 10.20 Factory default list】

## 9.3 WEB browser operations

---

The FDX-S can be controlled, monitored, or configured remotely also using an WEB browser.

### 9.3.1 Starting WEB browser

---

**To connect to the FDX-S using an WEB browser:**

1. Start the WEB browser. Maximizing the window size is recommended.
2. Enter the IP address that is programmed into the FDX-S in the address bar of the WEB browser.

Note that the default IP address is `http://192.168.1.199`

**【See: 10.14 LAN】**

## 9.3.2 Setting account

---

For the first access to the FDX-S WEB browser, you need to create an account.

Set the user ID and password.

[USER ID]: ASCII 30 to 39, 41 to 5A, 5F, 61 to 7A (0 to 9, A to Z, \_, a to z) Up to 24 characters

[PASSWORD]: ASCII 21 to 7D 8 to 24 characters

[CONFIRM PASSWORD]: ASCII 21 to 7D

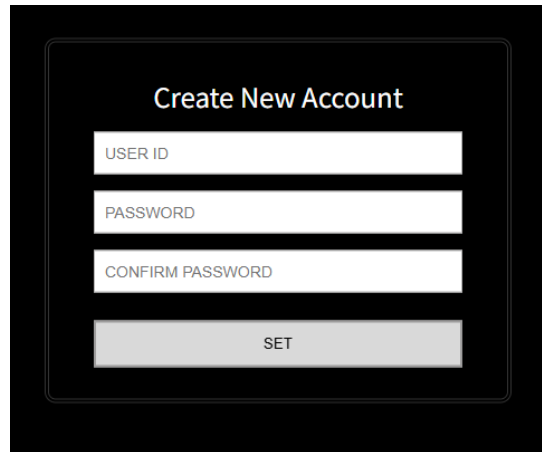

The image shows a screenshot of a web form titled "Create New Account". The form is contained within a dark rectangular frame. It features three input fields stacked vertically, each with a label above it: "USER ID", "PASSWORD", and "CONFIRM PASSWORD". Below these fields is a single button labeled "SET".

### 9.3.3 Logging in WEB browser

If the log-in feature of the WEB browser is enabled (enabled by default), you need to enter the user ID and password.

#### To log in WEB browser of the FDX-S:

1. Access to the WEB browser.
2. Enter the user ID and password.
3. Click the [LOGIN] button.  
[LOGOUT] button appears at the upper right.

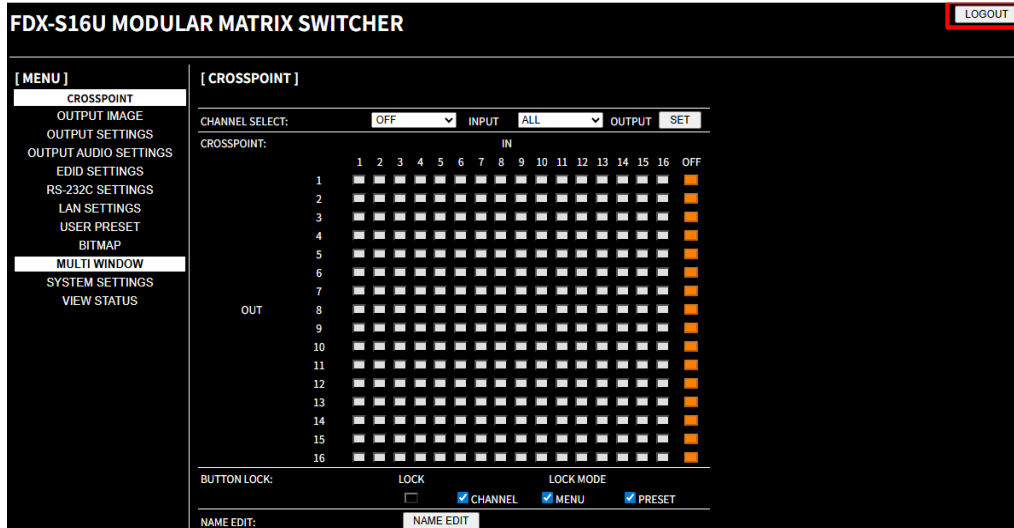
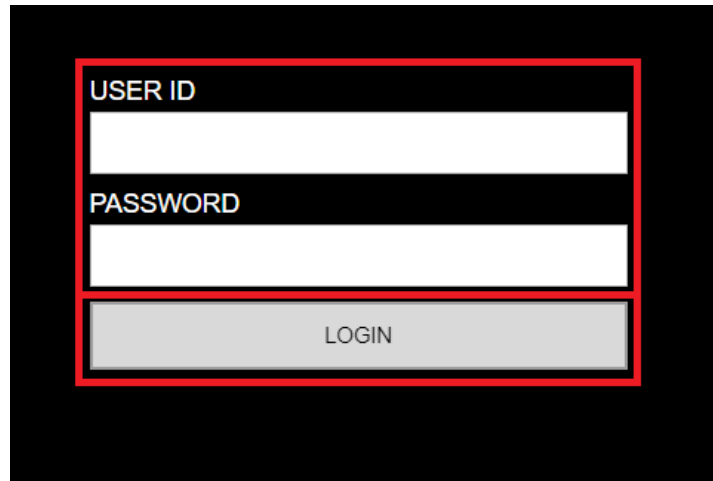

## 9.3.4 Logging out WEB browser

To log out WEB browser of the FDX-S:

1. Click the [LOGOUT] button.
2. As a confirmation message is displayed, select [OK].

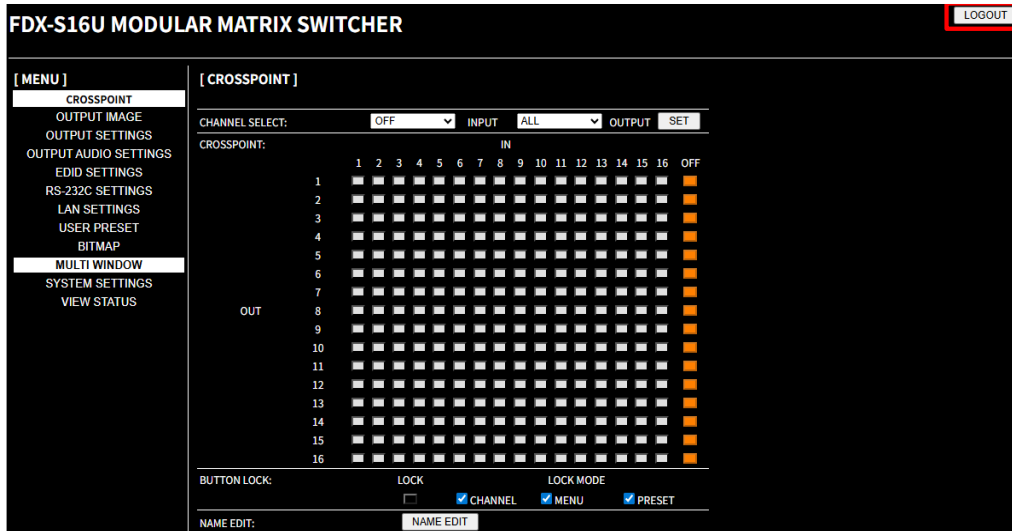

### 9.3.5 Normal/Advanced menu

The FDX-S menus consist of normal setting menus and advanced setting menus.

**To display advanced setting menus:**

1. Select [SYSTEM SETTINGS] from [MENU].
2. Set [ADVANCED MENU] to [ON]. It is set to [OFF] by default.

【See: 10.2 Menu】

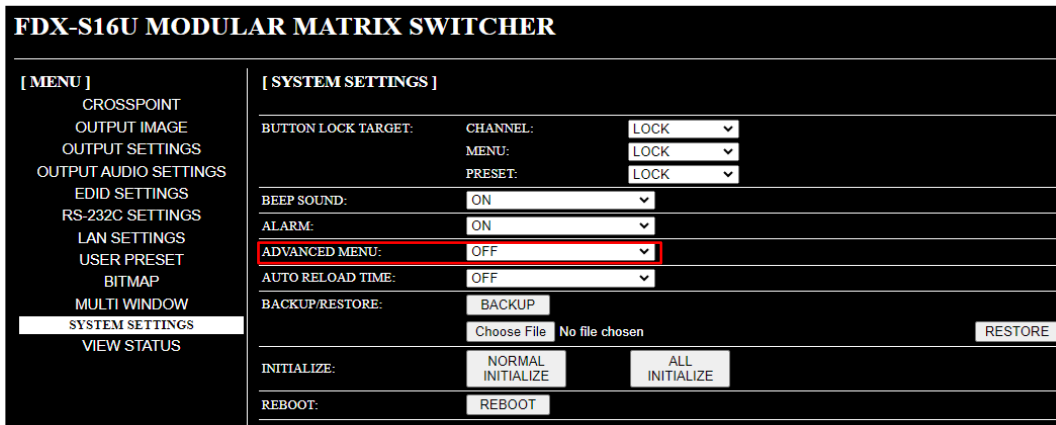

## 9.3.6 Setting login feature

You can improve security by using the login feature.

**To set login feature:**

1. Select [SYSTEM SETTINGS] from [MENU].
2. Click the [LOGIN SETTING] button.

The screenshot shows the web interface for the FDX-S16U MODULAR MATRIX SWITCHER. The title bar includes the device name and a LOGOUT button. A left-hand menu lists various settings categories, with 'SYSTEM SETTINGS' currently selected. The main content area displays the 'SYSTEM SETTINGS' page, which includes several configuration options such as 'BUTTON LOCK TARGET', 'BEEP SOUND', 'COMPATIBLE MODE', 'ALARM', 'ADVANCED MENU', 'POWER SAVE MODE', 'TOP PAGE', 'SELECT MODE', and 'AUTO RELOAD TIME'. The 'LOGIN SETTING' button is highlighted with a red box, indicating the next step in the process.

3. Enter the user ID and password.
4. Click the [LOGIN] button.

The screenshot shows a login form with two input fields: 'USER ID' and 'PASSWORD'. Both fields are highlighted with a red box. Below the input fields is a 'LOGIN' button.

5. To change the user ID and password, enter the desired ID and password. (If you do not intend to change them, you can skip this procedure.)

[USER ID]: ASCII 30 to 39, 41 to 5A, 5F, 61 to 7A (0 to 9, A to Z, \_, a to z) Up to 24 characters

[PASSWORD]: ASCII 21 to 7D 8 to 24 characters

[CONFIRM PASSWORD]: ASCII 21 to 7D 8 to 24 characters

6. To disable the login feature, set [LOGIN] to [OFF]. [ON] is set by default.

[ LOGIN SETTING ]

NEW USER ID

NEW PASSWORD  SET

CONFIRM PASSWORD

LOGIN ON ▾

END

**Notes**

- For the first-time setup, change the user ID and password.
- Multiple users cannot login at the same time. Only the last (subsequent) user can login.
- Once a user logs in, the session is kept until the user logs out or closes the browser.
- User ID and password are not saved to the backup file.
- Only if initialization command (@CLR,0) is initiated, the user ID and password are initialized.

### 9.3.7 Setting secure connection

To set secure connection (encrypted link that protects data):

1. Select [ON] or [OFF] from the [LAN SETTINGS] menu > [SECURE CONNECTION].  
[ON] is set by default.

The screenshot shows the web interface for the FDX-S16U Modular Matrix Switcher. The left sidebar contains a menu with options like CROSSPOINT, OUTPUT IMAGE, and LAN SETTINGS. The main area is titled '[ LAN SETTINGS ]' and contains various configuration fields. A red box highlights the 'SECURE CONNECTION' dropdown menu, which is currently set to 'ON'. Other visible settings include IP ADDRESS (192.168.0.34), SUBNET MASK (255.255.255.0), MAC ADDRESS (60-96-45-45-FF-00), and CONTROL PORT (1100).

### 9.3.8 Selecting server certificate

Types of the server certificate used for HTTPS:

[INTERNAL CERTIFICATE]: The internal server certificate is used.

[IMPORTED CERTIFICATE01]: The stored server certificate that was issued by another authority is used.

This screenshot is similar to the previous one, showing the same web interface. In this view, the 'SELECT CERTIFICATE' dropdown menu is highlighted with a red box and set to 'INTERNAL CERTIFICATE'. The 'SECURE CONNECTION' dropdown is also visible and set to 'ON'. The rest of the interface, including the menu and other settings, remains the same.

### 9.3.9 Selecting valid period of server certificate

To select a valid period from:

- [1 month]
- [3 months]
- [1 year + 1 month]
- [10 years]

**Notes**

- If the certificate expires, it cannot communicate with the FDX-S.
- When you updated the certificate, import the updated certificate to the server.

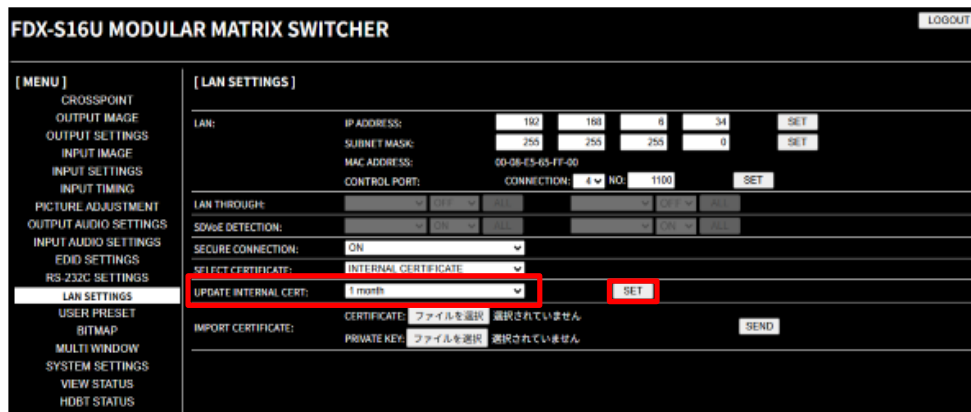

### 9.3.10 Storing server certificate

To store the server certificate and private key issued by another authority:

1. Select a file you want to store.
2. Click the [SEND] button.

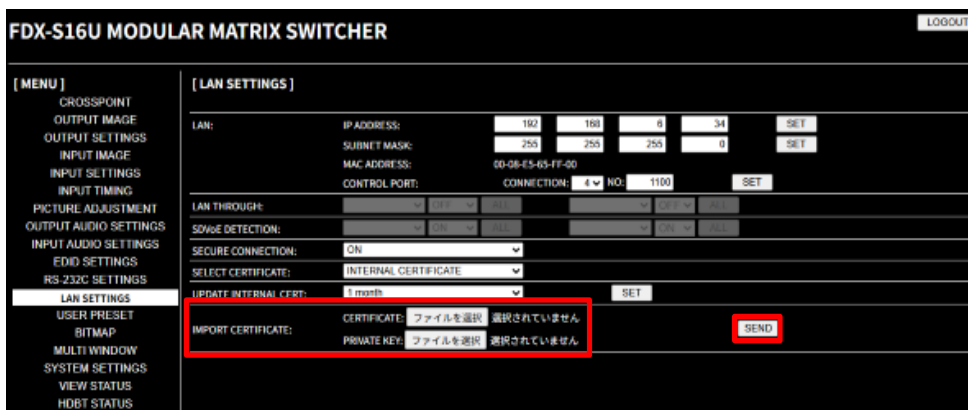

### 9.3.11 Editing crosspoint name

---

**To edit crosspoint name:**

1. Click the [NAME EDIT] button from [CROSSPOINT] to open the [NAME EDIT] window.
2. You can edit the following names:
  - Input channel name in the “Setting” tab
  - Output channel name in the “Setting” tab
  - Model number

Enter up to 10 one-byte characters for channel name while up to 40 one-byte characters for model number and product name.

The input channel name is also used for overlay text display of the 4K@60 scan conversion multiview output board.

**【See: 10.17.10 Overlay text position】**

### 9.3.12 Displaying HDBaseT information

The [HDBT STATUS] menu displays connected HDBaseT information.

To display this menu, switch menu display mode to Advanced setting menu.

【See: 10.18.4 Displaying advanced menu】

**FDX-S16U MODULAR MATRIX SWITCHER**

<p>[ MENU ]</p> <ul style="list-style-type: none"> <li>CROSSPOINT</li> <li>OUTPUT IMAGE</li> <li>OUTPUT SETTINGS</li> <li>INPUT IMAGE</li> <li>INPUT SETTINGS</li> <li>INPUT TIMING</li> <li>PICTURE ADJUSTMENT</li> <li>OUTPUT AUDIO SETTINGS</li> <li>INPUT AUDIO SETTINGS</li> <li>EDID SETTINGS</li> <li>RS-232C SETTINGS</li> <li>LAN SETTINGS</li> <li>USER PRESET</li> <li>BITMAP</li> <li>MULTIWINDOW</li> <li>SYSTEM SETTINGS</li> <li>VIEW STATUS</li> <li><b>HDBT STATUS</b></li> </ul>	<p>[ HDBT STATUS ]</p> <p>IN13-IN16</p> <table border="1" style="width: 100%; border-collapse: collapse;"> <tr> <td colspan="2"><b>[ SIGNAL STATUS ]</b></td> <td>IN13</td> <td>IN14</td> <td>IN15</td> <td>IN16</td> </tr> <tr> <td>VIDEO FORMAT</td> <td>:</td> <td>1920x1080p 59.93Hz</td> <td>1920x1080p 59.93Hz</td> <td>1920x1080p 59.93Hz</td> <td>1920x1080p 59.93Hz</td> </tr> <tr> <td>COLOR SPACE</td> <td>:</td> <td>YCbCr 4:4:4</td> <td>YCbCr 4:4:4</td> <td>YCbCr 4:4:4</td> <td>YCbCr 4:4:4</td> </tr> <tr> <td>DEEP COLOR</td> <td>:</td> <td>24 BIT COLOR</td> <td>24 BIT COLOR</td> <td>24 BIT COLOR</td> <td>24 BIT COLOR</td> </tr> <tr> <td>LINK STATUS</td> <td>:</td> <td>ON</td> <td>ON</td> <td>ON</td> <td>ON</td> </tr> <tr> <td>SOURCE STATUS</td> <td>:</td> <td>ON</td> <td>ON</td> <td>ON</td> <td>ON</td> </tr> </table> <table border="1" style="width: 100%; border-collapse: collapse;"> <tr> <td colspan="2"><b>[ DEVICE STATUS ]</b></td> <td>IN13</td> <td>IN14</td> <td>IN15</td> <td>IN16</td> </tr> <tr> <td>LOCAL DEV TYPE</td> <td>:</td> <td>VS100RX</td> <td>VS100RX</td> <td>VS100RX</td> <td>VS100RX</td> </tr> <tr> <td>LOCAL VERSION ID</td> <td>:</td> <td>13 07 21 00</td> <td>13 07 21 00</td> <td>13 07 21 00</td> <td>13 07 21 00</td> </tr> <tr> <td>LOCAL OPERATION MDOE</td> <td>:</td> <td>HDBT MODE</td> <td>HDBT MODE</td> <td>HDBT MODE</td> <td>HDBT MODE</td> </tr> <tr> <td>REMOTE DEV TYPE</td> <td>:</td> <td>VS100TX</td> <td>VS100TX</td> <td>VS100TX</td> <td>VS100TX</td> </tr> <tr> <td>REMOTE VERSION ID</td> <td>:</td> <td>13 07 21 10</td> <td>13 07 21 10</td> <td>13 07 21 10</td> <td>13 07 21 10</td> </tr> <tr> <td>REMOTE OPERATION MDOE</td> <td>:</td> <td>HDBT MODE</td> <td>HDBT MODE</td> <td>HDBT MODE</td> <td>HDBT MODE</td> </tr> </table> <table border="1" style="width: 100%; border-collapse: collapse;"> <tr> <td colspan="2"><b>[ CABLE STATUS ]</b></td> <td>IN13</td> <td>IN14</td> <td>IN15</td> <td>IN16</td> </tr> <tr> <td>CABLE LENGTH</td> <td>:</td> <td>&lt;20m</td> <td>&lt;20m</td> <td>&lt;20m</td> <td>&lt;20m</td> </tr> <tr> <td>VIDEO BER</td> <td>:</td> <td>10e-10</td> <td>10e-10</td> <td>10e-10</td> <td>10e-10</td> </tr> <tr> <td>FMSEERR (dB)</td> <td>:</td> <td>A B C D</td> <td>A B C D</td> <td>A B C D</td> <td>A B C D</td> </tr> <tr> <td>CURRENT VALUE</td> <td>:</td> <td>-21 -19 -20 -21</td> <td>-20 -20 -20 -21</td> <td>-20 -20 -22 -22</td> <td>-20 -19 -21 -21</td> </tr> <tr> <td>MAX VALUE</td> <td>:</td> <td>-21 -19 -20 -21</td> <td>-20 -19 -20 -21</td> <td>-20 -20 -22 -21</td> <td>-20 -18 -21 -21</td> </tr> <tr> <td>FMAXERR</td> <td>:</td> <td>A B C D</td> <td>A B C D</td> <td>A B C D</td> <td>A B C D</td> </tr> <tr> <td>CURRENT VALUE</td> <td>:</td> <td>0.65 0.75 0.65 0.59</td> <td>0.68 0.75 0.71 0.62</td> <td>0.71 0.71 0.62 0.65</td> <td>0.65 0.81 0.62 0.62</td> </tr> <tr> <td>MAXVALUE</td> <td>:</td> <td>0.65 0.75 0.65 0.59</td> <td>0.68 0.75 0.71 0.62</td> <td>0.71 0.71 0.62 0.65</td> <td>0.65 0.81 0.62 0.62</td> </tr> </table> <p> <span style="color: green;">■</span>:NORMAL  <span style="color: orange;">■</span>:CAUTION  <span style="color: red;">■</span>:WARNING         </p> <p style="text-align: center;"><input type="button" value="RESET MAX VALUES"/></p>	<b>[ SIGNAL STATUS ]</b>		IN13	IN14	IN15	IN16	VIDEO FORMAT	:	1920x1080p 59.93Hz	1920x1080p 59.93Hz	1920x1080p 59.93Hz	1920x1080p 59.93Hz	COLOR SPACE	:	YCbCr 4:4:4	YCbCr 4:4:4	YCbCr 4:4:4	YCbCr 4:4:4	DEEP COLOR	:	24 BIT COLOR	24 BIT COLOR	24 BIT COLOR	24 BIT COLOR	LINK STATUS	:	ON	ON	ON	ON	SOURCE STATUS	:	ON	ON	ON	ON	<b>[ DEVICE STATUS ]</b>		IN13	IN14	IN15	IN16	LOCAL DEV TYPE	:	VS100RX	VS100RX	VS100RX	VS100RX	LOCAL VERSION ID	:	13 07 21 00	13 07 21 00	13 07 21 00	13 07 21 00	LOCAL OPERATION MDOE	:	HDBT MODE	HDBT MODE	HDBT MODE	HDBT MODE	REMOTE DEV TYPE	:	VS100TX	VS100TX	VS100TX	VS100TX	REMOTE VERSION ID	:	13 07 21 10	13 07 21 10	13 07 21 10	13 07 21 10	REMOTE OPERATION MDOE	:	HDBT MODE	HDBT MODE	HDBT MODE	HDBT MODE	<b>[ CABLE STATUS ]</b>		IN13	IN14	IN15	IN16	CABLE LENGTH	:	<20m	<20m	<20m	<20m	VIDEO BER	:	10e-10	10e-10	10e-10	10e-10	FMSEERR (dB)	:	A B C D	A B C D	A B C D	A B C D	CURRENT VALUE	:	-21 -19 -20 -21	-20 -20 -20 -21	-20 -20 -22 -22	-20 -19 -21 -21	MAX VALUE	:	-21 -19 -20 -21	-20 -19 -20 -21	-20 -20 -22 -21	-20 -18 -21 -21	FMAXERR	:	A B C D	A B C D	A B C D	A B C D	CURRENT VALUE	:	0.65 0.75 0.65 0.59	0.68 0.75 0.71 0.62	0.71 0.71 0.62 0.65	0.65 0.81 0.62 0.62	MAXVALUE	:	0.65 0.75 0.65 0.59	0.68 0.75 0.71 0.62	0.71 0.71 0.62 0.65	0.65 0.81 0.62 0.62
<b>[ SIGNAL STATUS ]</b>		IN13	IN14	IN15	IN16																																																																																																																																
VIDEO FORMAT	:	1920x1080p 59.93Hz	1920x1080p 59.93Hz	1920x1080p 59.93Hz	1920x1080p 59.93Hz																																																																																																																																
COLOR SPACE	:	YCbCr 4:4:4	YCbCr 4:4:4	YCbCr 4:4:4	YCbCr 4:4:4																																																																																																																																
DEEP COLOR	:	24 BIT COLOR	24 BIT COLOR	24 BIT COLOR	24 BIT COLOR																																																																																																																																
LINK STATUS	:	ON	ON	ON	ON																																																																																																																																
SOURCE STATUS	:	ON	ON	ON	ON																																																																																																																																
<b>[ DEVICE STATUS ]</b>		IN13	IN14	IN15	IN16																																																																																																																																
LOCAL DEV TYPE	:	VS100RX	VS100RX	VS100RX	VS100RX																																																																																																																																
LOCAL VERSION ID	:	13 07 21 00	13 07 21 00	13 07 21 00	13 07 21 00																																																																																																																																
LOCAL OPERATION MDOE	:	HDBT MODE	HDBT MODE	HDBT MODE	HDBT MODE																																																																																																																																
REMOTE DEV TYPE	:	VS100TX	VS100TX	VS100TX	VS100TX																																																																																																																																
REMOTE VERSION ID	:	13 07 21 10	13 07 21 10	13 07 21 10	13 07 21 10																																																																																																																																
REMOTE OPERATION MDOE	:	HDBT MODE	HDBT MODE	HDBT MODE	HDBT MODE																																																																																																																																
<b>[ CABLE STATUS ]</b>		IN13	IN14	IN15	IN16																																																																																																																																
CABLE LENGTH	:	<20m	<20m	<20m	<20m																																																																																																																																
VIDEO BER	:	10e-10	10e-10	10e-10	10e-10																																																																																																																																
FMSEERR (dB)	:	A B C D	A B C D	A B C D	A B C D																																																																																																																																
CURRENT VALUE	:	-21 -19 -20 -21	-20 -20 -20 -21	-20 -20 -22 -22	-20 -19 -21 -21																																																																																																																																
MAX VALUE	:	-21 -19 -20 -21	-20 -19 -20 -21	-20 -20 -22 -21	-20 -18 -21 -21																																																																																																																																
FMAXERR	:	A B C D	A B C D	A B C D	A B C D																																																																																																																																
CURRENT VALUE	:	0.65 0.75 0.65 0.59	0.68 0.75 0.71 0.62	0.71 0.71 0.62 0.65	0.65 0.81 0.62 0.62																																																																																																																																
MAXVALUE	:	0.65 0.75 0.65 0.59	0.68 0.75 0.71 0.62	0.71 0.71 0.62 0.65	0.65 0.81 0.62 0.62																																																																																																																																

**[Table 9.4] HDBaseT information**

[1/2]

Item	Value to be displayed	Description
<b>Video signal information</b>		
● Resolution I/O status		
VIDEO FORMAT	1920x1080p 60.00Hz	Video signal information (1920x1080p 60 Hz)
	NO SIGNAL	No input signal
● Color space I/O status		
COLOR SPACE	YCbCr4:2:0	YCbCr 4:2:0
● Color depth I/O status		
DEEP COLOR	24 BIT COLOR	24 bit/pixel (8bit/component)
● Link status		
LINK STATUS	ON	Connected to transmitter or receiver
	OFF	Not connected
● Source status		
SOURCE STATUS	ON	Connected to source device
	OFF	Not connected
● Sink status		
SINK STATUS	ON	Connected to sink device
	OFF	Not connected
<b>Device information</b>		
● Device type		
LOCAL DEV TYPE	VS100RX	Example: VS100RX
● Version ID		
LOCAL VERSION ID	13 07 21 00	Example: 13.07.21.00
● Operation mode		
LOCAL OPERATION MODE	HDBaseT MODE	HDBaseT mode
	LONG REACH MODE	Long reach mode
	LPPF1 MODE	LOW POWER mode 1
	LPPF2 MODE	LOW POWER mode 2
● Connected device type		
REMOTE DEV TYPE	VS100TX	Example: VS100TX
	UNCONNECTED	Not connected
● Connected version ID		
REMOTE VERSION ID	13 07 21 10	Example: 13.07.21.10

Item	Value to be displayed	Description
<b>Device information (Cont'd)</b>		
● Operation mode of remote device		
REMOTE OPERATION MODE	HDBaseT MODE	HDBaseT mode
	LONG REACH MODE	Long reach mode
	LPPF1 MODE	LOW POWER mode 1
	LPPF2 MODE	LOW POWER mode 2
<b>Category cable information</b>		
● Category cable length		
CABLE LENGTH	85m	Category cable length Example: 279 ft. (85 m)
	<20m	66 ft. (20 m) or shorter
	100m<	328 ft. (100 m) or longer
	UNCONNECTED	Not connected
● Bit error rate		
VIDEO BER	10e-11	Signal bit error rate Example: 10e-11
	UNCONNECTED	Not connected
● Signal quality		
FMSEERR (dB) CURRENT VALUE	A : -22 B : -20 C : -21 D : -22	Example: A-22dB, B-20dB, C-21dB, D-22dB
	---	Not connected
● Maximum signal quality		
FMSEERR (dB) MAX VALUE	A : -22 B : -20 C : -21 D : -22	Example: A-22dB, B-20dB, C-21dB, D-22dB
	---	Not connected or [RESET MAX VALUES] is selected.
● Residual gap		
FMAXERR CURRENT VALUE	A : 0.34 B : 0.35 C : 0.32 D : 0.33	Example: A0.34, B0.35, C0.32, D0.33
	---	Not connected
● Maximum residual gap		
FMAXERR MAX VALUE	A : 0.34 B : 0.35 C : 0.32 D : 0.33	Example: A0.34, B0.35, C0.32, D0.33
	---	Not connected or [RESET MAX VALUES] is selected.

**Note:**

The displayed values may differ from real value depending on environment.

### 9.3.13 Registering bitmap

Bitmap files can be registered if a scan converter output board is installed.

- 1080p scan conversion output board:  
Up to four 2048x1152 or smaller bitmaps can be registered.
- 4K@60 scan conversion output board and 4K@60 scan conversion multiview output board:  
2K mode : Up to four 2048x1152 or smaller bitmaps can be registered.  
4K mode : One 4096x2160 or smaller bitmaps can be registered.

**To register bitmap file:**

1. Select [SYSTEM SETTINGS] from [MENU]. 【See: 10.18.4 Displaying advanced menu】
2. Set [ADVANCED MENU] to [ON].
3. 2K mode (2048x1152 or less) is set by default for 4K@60 scan conversion output board and 4K@60 scan conversion multiview output board. To register a bigger bitmap, change [MEMORY MODE] to [4K (1 BITMAP)].
4. Select the bitmap number (②). Click [BITMAP] > [Choose File] and select the desired bitmap file (③).
5. Click the [SEND] button (④) to register the bitmap file to the bitmap number.  
Do not operate WEB browser or power off the FDX-S until it is completed.
6. A message “Bitmap file has been saved.” appears if it is registered correctly.  
An error message appears if registration fails.

【See: 10.16 Bitmap】

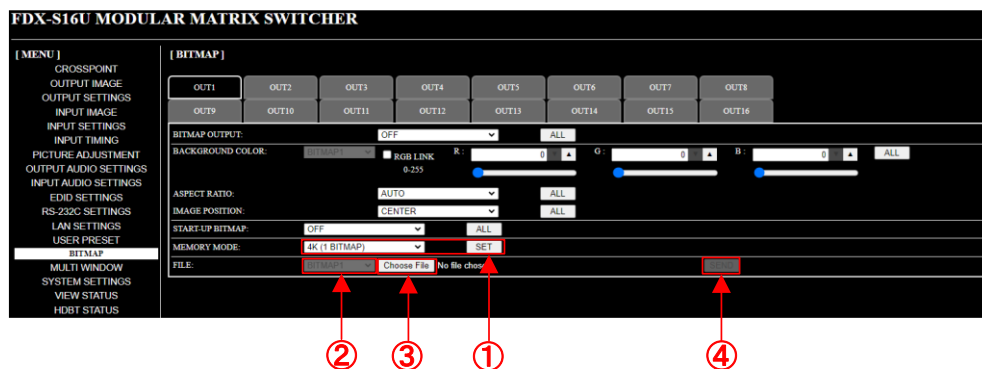

**[Table 9.5] Error message**

Message	Description
File Name is invalid.	The specified file name is not correct.
File Format Error has occurred.	The FDX-S does not support this file.
File Size exceeds the capacity.	The file exceeds the maximum resolution.
Memory Allocation Error has occurred.	The memory for temporarily saving bitmap file could not be reserved. The error may possibly be solved by turning off the “POWER” switch, turning on the switch again, and sending the bitmap file again.

### 9.3.14 Crosspoint menu for audio board

To display the crosspoint menu in another window.

1. Select [OUTPUT AUDIO SETTINGS].
2. Select [DIGITAL OUTPUT] or [ANALOG OUTPUT].
3. Click [CROSSPOINT] to display the list of all outputs in another window.

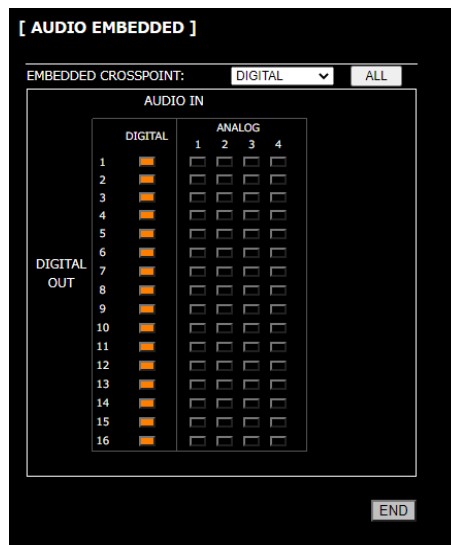
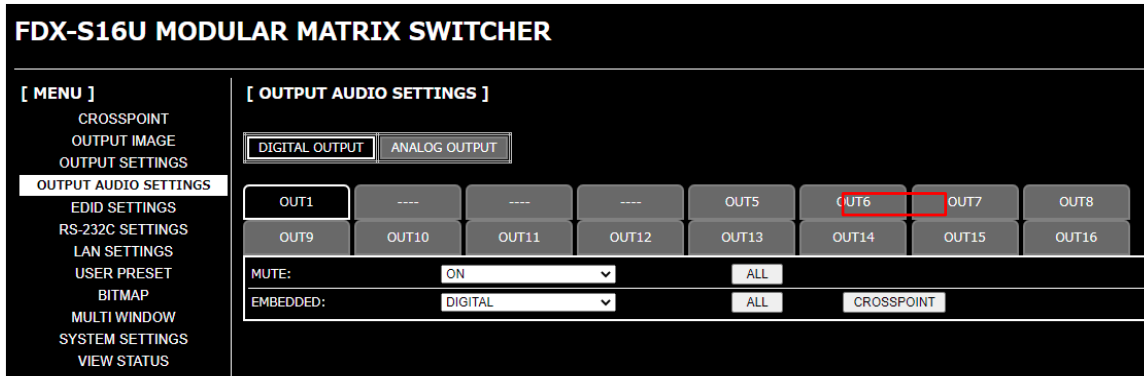

### 9.3.15 Automatic reload

To set automatic reload interval of [CROSSPOINT], [VIEW STATUS], [HDBT STATUS] windows, and crosspoint menu windows of [EMBEDDED] and [DE-EMBEDDED]:

1. Select [SYSTEM SETTINGS] from [MENU].
2. Select the desired interval in 5-seconds increments (5 to 60 seconds) for [AUTO RELOAD TIME].  
[OFF] (default) for [AUTO RELOAD TIME]: [CROSSPOINT] and [VIEW STATUS] windows are not updated automatically.

FDX-S16U MODULAR MATRIX SWITCHER	
<b>[ MENU ]</b> CROSSPOINT OUTPUT IMAGE OUTPUT SETTINGS OUTPUT AUDIO SETTINGS EDID SETTINGS RS-232C SETTINGS LAN SETTINGS USER PRESET BITMAP MULTI WINDOW <b>SYSTEM SETTINGS</b> VIEW STATUS	<b>[ SYSTEM SETTINGS ]</b> BUTTON LOCK TARGET: CHANNEL: LOCK MENU: LOCK PRESET: LOCK BEEP SOUND: ON ALARM: ON ADVANCED MENU: OFF <b>AUTO RELOAD TIME: OFF</b> BACKUP/RESTORE: BACKUP Choose File No file chosen RESTORE INITIALIZE: NORMAL INITIALIZE ALL INITIALIZE REBOOT: REBOOT

### 9.3.16 Saving/Restoring settings

To save settings to a folder as a backup file:

1. Select [SYSTEM SETTINGS] from [MENU].
2. Click the [BACKUP] button of [BACKUP/RESTORE].

Back-up file name can be edited.

If fails, an error message is displayed.

FDX-S16U MODULAR MATRIX SWITCHER	
<b>[ MENU ]</b> CROSSPOINT OUTPUT IMAGE OUTPUT SETTINGS OUTPUT AUDIO SETTINGS EDID SETTINGS RS-232C SETTINGS LAN SETTINGS USER PRESET BITMAP MULTI WINDOW <b>SYSTEM SETTINGS</b> VIEW STATUS	<b>[ SYSTEM SETTINGS ]</b> BUTTON LOCK TARGET: CHANNEL: LOCK MENU: LOCK PRESET: LOCK BEEP SOUND: ON ALARM: ON ADVANCED MENU: OFF AUTO RELOAD TIME: OFF <b>BACKUP/RESTORE: BACKUP</b> Choose File No file chosen RESTORE INITIALIZE: NORMAL INITIALIZE ALL INITIALIZE REBOOT: REBOOT

**To restore settings from PC:**

1. Select [SYSTEM SETTINGS] from [MENU].
2. Select a file from [Choose File].
3. Click the [RESTORE] button of [BACKUP/RESTORE]. The FDX-S reboots automatically.  
Do not perform other WEB operations or power off the FDX-S during the operation.
4. If the restoration fails, an alert dialog appears during the operation.

**Note:**

Do not power off the FDX-S or perform WEB menu operation until restoring finishes.

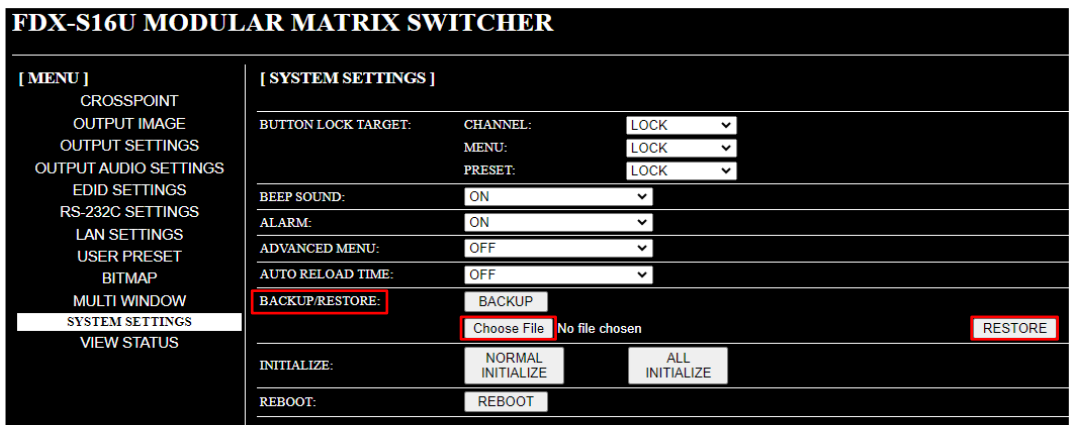

**[Table 9.6] Error message**

Message	Description
File Name is invalid.	The specified file name is not correct.
Memory Allocation Error has occurred.	The memory for temporarily saving setting file could not be reserved. The error may possibly be solved by turning on the “POWER” switch and then power on the FDX-S.

## 9.3.17 Initialization

### To initialize settings:

1. Select [SYSTEM SETTINGS] from [MENU].
2. For initializing settings except for the bitmap memory mode and LAN communication settings: Click the [NORMAL INITIALIZE] button.

For initializing all settings except for the bitmap memory mode setting: Click the [ALL INITIALIZE] button.

【See: 10.20 Factory default list】

FDX-S16U MODULAR MATRIX SWITCHER	
<b>[ MENU ]</b> CROSSPOINT OUTPUT IMAGE OUTPUT SETTINGS OUTPUT AUDIO SETTINGS EDID SETTINGS RS-232C SETTINGS LAN SETTINGS USER PRESET BITMAP MULTI WINDOW <b>SYSTEM SETTINGS</b> VIEW STATUS	<b>[ SYSTEM SETTINGS ]</b> BUTTON LOCK TARGET: CHANNEL: LOCK MENU: LOCK PRESET: LOCK BEEP SOUND: ON ALARM: ON ADVANCED MENU: OFF AUTO RELOAD TIME: OFF BACKUP/RESTORE: BACKUP Choose File No file chosen RESTORE <b>INITIALIZE: NORMAL INITIALIZE ALL INITIALIZE</b> REBOOT: REBOOT

### Note:

The user ID, security settings, password for the web login function are not initialized.

## 9.4 Dante

---

Dante (Digital Audio Network Through Ethernet) is an audio networking technology developed by Audinate. The FDX-S separates audio that is embedded to input video signal and converts the audio to Dante format (48 kHz; 24 bits) in order to output it as network audio. The FDX-S also can embed input Dante audio to output video signal.

【See: 10.10.3 Audio embedding】

【See: 10.10.4 Audio de-embedding】

The FDX-SAB64D can transmit up to 64 Dante input channels and 64 Dante output channels. Stereo L/R audio is assigned to two Dante audio channels. The multi-channel LPCM audio is down mixed to 2-channel audio signal and output. Use DANTE01 to 32. For audio boards installed to the FDX-S64U, [DANTE-A01 to A32] is displayed for OPTION A while [DANTE-B01 to B32] is displayed for OPTION B.

**[Table 9.7] FDX-S setting value and Dante Controller input channel**

FDX-S setting value	FDX-S assigned stereo audio	Dante Controller Receivers CH
DANTE IN1	Left	01
	Right	02
DANTE IN2	Left	03
	Right	04
DANTE IN3	Left	05
	Right	06
DANTE IN4	Left	07
	Right	08
DANTE IN5	Left	09
	Right	10
DANTE IN6	Left	11
	Right	12
DANTE IN7	Left	13
	Right	14
DANTE IN8	Left	15
	Right	16
DANTE IN9	Left	17
	Right	18
DANTE IN10	Left	19
	Right	20
DANTE IN11	Left	21
	Right	22
DANTE IN12	Left	23
	Right	24
DANTE IN13	Left	25
	Right	26
DANTE IN14	Left	27
	Right	28
DANTE IN15	Left	29
	Right	30
DANTE IN16	Left	31
	Right	32

FDX-S setting value	FDX-S assigned stereo audio	Dante Controller Receivers CH
DANTE IN17	Left	33
	Right	34
DANTE IN18	Left	35
	Right	36
DANTE IN19	Left	37
	Right	38
DANTE IN20	Left	39
	Right	40
DANTE IN21	Left	41
	Right	42
DANTE IN22	Left	43
	Right	44
DANTE IN23	Left	45
	Right	46
DANTE IN24	Left	47
	Right	48
DANTE IN25	Left	49
	Right	50
DANTE IN26	Left	51
	Right	52
DANTE IN27	Left	53
	Right	54
DANTE IN28	Left	55
	Right	56
DANTE IN29	Left	57
	Right	58
DANTE IN30	Left	59
	Right	60
DANTE IN31	Left	61
	Right	62
DANTE IN32	Left	63
	Right	64

**[Table 9.8] FDX-S setting value and Dante Controller output channel**

FDX-S setting value	FDX-S assigned stereo audio	Dante Controller Transmitters CH
DANTE OUT1	Left	01
	Right	02
DANTE OUT2	Left	03
	Right	04
DANTE OUT3	Left	05
	Right	06
DANTE OUT4	Left	07
	Right	08
DANTE OUT5	Left	09
	Right	10
DANTE OUT6	Left	11
	Right	12
DANTE OUT7	Left	13
	Right	14
DANTE OUT8	Left	15
	Right	16
DANTE OUT9	Left	17
	Right	18
DANTE OUT10	Left	19
	Right	20
DANTE OUT11	Left	21
	Right	22
DANTE OUT12	Left	23
	Right	24
DANTE OUT13	Left	25
	Right	26
DANTE OUT14	Left	27
	Right	28
DANTE OUT15	Left	29
	Right	30
DANTE OUT16	Left	31
	Right	32

FDX-S setting value	FDX-S assigned stereo audio	Dante Controller Transmitters CH
DANTE OUT17	Left	33
	Right	34
DANTE OUT18	Left	35
	Right	36
DANTE OUT19	Left	37
	Right	38
DANTE OUT20	Left	39
	Right	40
DANTE OUT21	Left	41
	Right	42
DANTE OUT22	Left	43
	Right	44
DANTE OUT23	Left	45
	Right	46
DANTE OUT24	Left	47
	Right	48
DANTE OUT25	Left	49
	Right	50
DANTE OUT26	Left	51
	Right	52
DANTE OUT27	Left	53
	Right	54
DANTE OUT28	Left	55
	Right	56
DANTE OUT29	Left	57
	Right	58
DANTE OUT30	Left	59
	Right	60
DANTE OUT31	Left	61
	Right	62
DANTE OUT32	Left	63
	Right	64

**Notes:**

- Compressed audio is not output as Dante audio and the audio will be muted.
- Dante I/O sampling frequency is 48 kHz. Only the same sampling frequency can be transmitted between Dante devices.

## 9.4.1 Dante network connection

Redundant connection and Daisy chain connection (Redundant connection is set by default) are supported for Dante devices.

The IP address for Dante connectors (Primary and Secondary) is automatically obtained over IP network. If two Dante audio boards are installed to the FDX-S64U, connect these Dante boards to the network. Use a Cat5e or better cable.

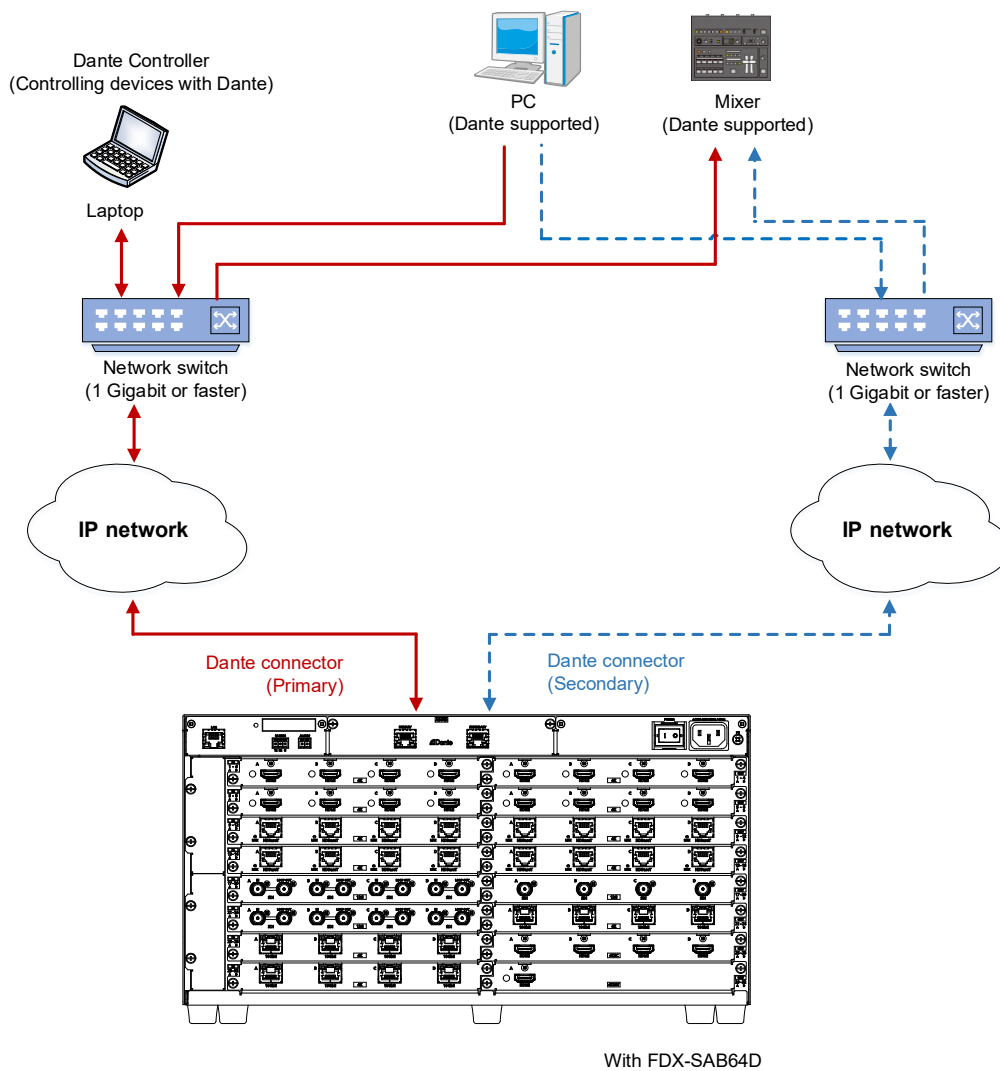

**Note:**

For redundant operation, do not connect the Dante primary and secondary connectors to the same IP network.

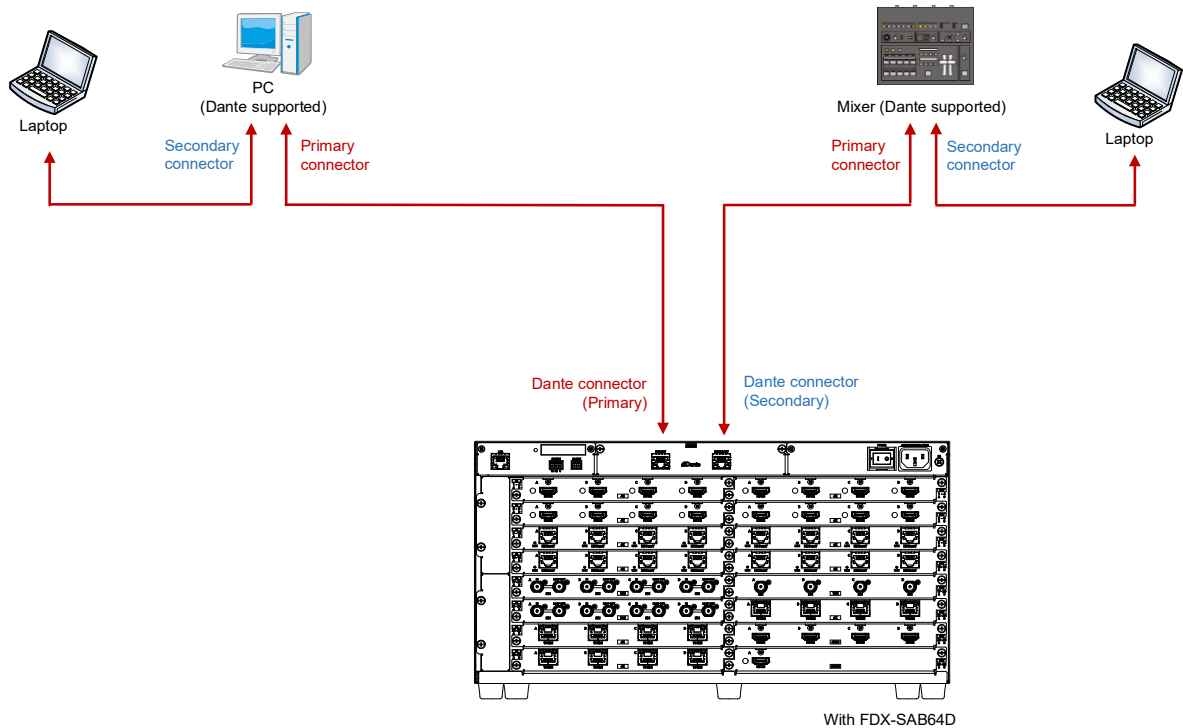

## 9.4.2 Dante Controller

Dante Controller is software released by Audinate for controlling Dante output functions and audio routing with Dante devices. These settings are saved in each Dante device.

For “Dante Controller” details and to download the software, visit the website below:  
<https://www.audinate.com/>

## 9.5 Controlled by IP-NINJAR Configurator

The FDX-S connected to LAN can be set from the IP-NINJAR Configurator remotely over LAN communication.

Refer to the IP-NINJAR Configurator User Guide for operations from the IP-NINJAR Configurator.

If the output detection function is disabled, the IP-NINJAR Configurator cannot detect the FDX-S and the Configurator cannot be used to control the FDX-S.

【See: 10.14.8 Sending SDVoE device detection packet (Output)】

【See: 10.14.9 Sending SDVoE device detection packet (Input)】

Please contact us to download the IP-NINJAR Configurator.

# 10 Configuration and Control

## 10.1 Board channel configuration

- Output channel configuration is changed depending on the output board type.
    - 4K@60 scan conversion output board : An output board has two channels.
    - 4K@60 scan conversion multiview output board : An output board has one channel.
    - Other output boards : An output board has four channels.
  - The channel numbers of 4K@60 scan conversion output board are the first two channels only; the remaining two channels cannot be set.
  - For the 4K@60 scan conversion multiview output board, the top channel number is valid. For some menus, four channels including the top channel are assigned as multi windows.
- 【See: 10.17 Multi window output】
- Example: Valid channels in the configuration below:
    - SLOT1 and 2 : An output board has four channels. No.1 to 8 are valid.
    - SLOT3 : For 4K@60 scan conversion multiview output board: No. 9 and No. 10 are valid; No.11 and No.12 cannot be selected.
    - SLOT4 : For 4K@60 scan conversion multiview output board: No.13 is valid; No.14 to No.16 cannot be used, but No.13 to No.16 are assigned as multi windows A to D in some menus.

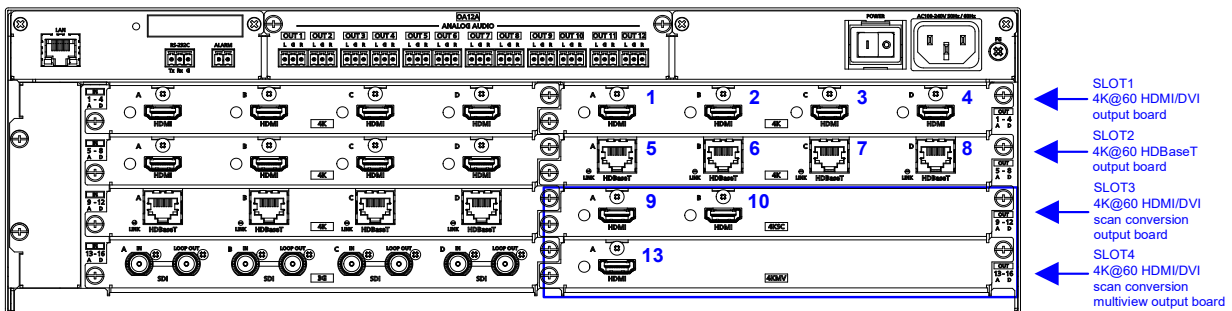

With FDX-SOA12A

## 10.2 Menu

---

The FDX-S menus consist of normal setting menus and advanced setting menus.

You can switch setting menu/advanced menu, using the “MENU/ENTER” button ([FUNCTION SELECT] → [SYSTEM SETTINGS] → [ADVANCED MENU]).

The number of I/O channels and boards vary depending on the model.

“n” in this section shows the number of channels.

“m” in this section shows the number of boards.

**[Table 10.1] The number of channels**

P/N	n (number of channels)	m (number of boards)
FDX-S08U	8	2
FDX-S16U	16	4
FDX-S32U	32	8
FDX-S64U	64	16

If I/O channels and board numbers to which no board is installed cannot be selected, “NO BOARD” is displayed.

## 10.2.1 Normal setting menu

### FDX-S Series

— CROSS POINT P.86	— RS-232C SETTINGS P.141
(CROSS POINT)	(RS-232C)
└─ VIEW SELECTED CHANNELS	└─ PARAMETERS
(Displaying crosspoint)	(RS-232C communication)
— OUTPUT IMAGE P.87	— LAN SETTINGS P.141
(Output position, size, and masking)	(LAN)
└─ RESOLUTION	└─ IP ADDRESS
(Output resolution)	(IP address)
└─ IMAGE POSITION	└─ SUBNET MASK
(Image position)	(Subnet mask)
└─ IMAGE SIZE	└─ GATEWAY ADDRESS
(Image size)	(Gateway address)
└─ BACKGROUND COLOR	└─ MAC ADDRESS
(Background color)	(MAC address)
└─ TEST PATTERN	└─ AUTO DISCONNECT
(Test pattern)	(Automatic disconnection time (Timeout))
— OUTPUT SETTINGS P.101	— USER PRESET P.144
(Output)	(Preset memory)
└─ NO SIGNAL IMAGE	└─ RECALL CROSSPOINT
(Output video for when no input video)	(Recalling crosspoint)
└─ SIGNAL EQUALIZATION	└─ STORE CROSSPOINT
(Output equalizer)	(Saving crosspoint)
└─ HDBT LONG REACH MODE	└─ RECALL PRESET SETTINGS
(HDBaseT output long reach mode)	(Recalling preset memory)
— OUTPUT AUDIO SETTINGS P.127	└─ STORE PRESET SETTINGS
(Output audio)	(Saving preset memory)
└─ MUTE	└─ START-UP
(Mute)	(Start-up setting)
└─ EMBEDDED	— BITMAP P.148
(Audio embedding)	(Bitmap)
└─ DE-EMBEDDED	└─ BITMAP OUTPUT
(Audio de-embedding)	(Bitmap image output)
└─ AUDIO OUT SELECT	— MULTI WINDOW P.154
(Audio setting)	(Multi window output)
— EDID SETTINGS P.131	└─ WINDOW POSITION
(EDID)	(Window position)
└─ RESOLUTION	└─ WINDOW SIZE
(Resolution)	(Window size)
└─ SINK DEVICE EDID COPY	└─ IMAGE POSITION
(Copying EDID)	(Image position)
└─ CH. FOR EXTERNAL MODE	└─ IMAGE SIZE
(External EDID)	(Image size)
└─ FRAME RATE	└─ RECALL PATTERN
(Frame rate)	(Recalling multi window memory)
	└─ STORE PATTERN
	(Saving multi window memory)

- SYSTEM SETTINGS P.165
  - | (Configuring FDX-S)
  - BUTTON LOCK TARGET
    - | (Grouping front panel security lockout)
  - BEEP SOUND
    - | (Beep)
  - ALARM
    - | (Alarm)
  - ADVANCED MENU
    - | (Displaying advanced menu)

- VIEW STATUS P.173
  - | (Status indication)
  - INPUT STATUS
    - | (Input signal status)
  - SINK DEVICE STATUS
    - | (Sink device status)
  - SINK DEVICE EDID
    - | (Viewing sink device EDID)
  - SYSTEM STATUS
    - | (System status)
  - VERSION
    - | (Device information)

## 10.2.2 Advanced setting menu

### FDX-S Series

- CROSS POINT P.86
  - | (CROSS POINT)
  - VIEW SELECTED CHANNELS
    - | (Displaying crosspoint)
- OUTPUT IMAGE P.87
  - | (Output position, size, and masking)
  - RESOLUTION
    - | (Output resolution)
  - ASPECT RATIO
    - | (Aspect ratio for sink device)
  - IMAGE POSITION
    - | (Image position)
  - IMAGE SIZE
    - | (Image size)
  - BACKGROUND COLOR
    - | (Background color)
  - TEST PATTERN
    - | (Test pattern)
  - VIDEO WALL TYPE
    - | (Videowall configuration)
  - VIDEO WALL POSITION
    - | (Videowall position)
  - VIDEO FRAME DELAY
    - | (Frame delay)
  - VIDEO SYNC MODE
    - | (Synchronization mode)
  - VIDEO SYNC PROCESSING
    - | (Video synchronization)

- OUTPUT SETTINGS P.101
  - | (Output)
  - SYNC. SIGNAL OUTPUT
    - | (Disabling synchronous signal output when no video signal is input)
  - NO SIGNAL IMAGE
    - | (Output video for when no input video)
  - HDCP OUTPUT MODE
    - | (HDCP output)
  - SIGNAL EQUALIZATION
    - | (Output equalizer)
  - SIGNAL FORMAT
    - | (Output format)
  - Output RGB range
    - | (Output RGB range)
  - HDBT LONG REACH MODE
    - | (HDBaseT output long reach mode)
  - DEEP COLOR
    - | (Deep Color output)
  - VIDEO SWITCHING EFFECT
    - | (Window transition effect)
  - EDID ERR. OUTPUT MODE
    - | (Sink device EDID check)
  - HOTPLUG MASK
    - | (Hot plug ignoring duration)
  - DDC POWER OUT
    - | (DDC power output when no signal is input)
  - SDI COLOR SPACE CONV.
    - | (SDI output format conversion)
  - SDI OUTPUT MODE
    - | (SDI output gearbox mode)
- INPUT IMAGE P.113
  - | (Input position, size, and cropping)
  - ASPECT RATIO
    - | (Aspect ratio)

**INPUT SETTINGS** P.114

(Input)

- NO INPUT MONITORING  
(No-signal input monitoring)
- HDCP INPUT MODE  
(HDCP input)
- HDBT LONG REACH MODE  
(HDBaseT input long reach mode)
- 3G-SDI DUAL STREAM  
(3G-SDI Dual Stream signal input)
- SDI INPUT MODE  
(SDI input gearbox mode)

**INPUT TIMING** P.122

(Input timing)

- H START POSITION  
(Horizontal start position)
- H ACTIVE  
(Horizontal active area)
- V START POSITION  
(Vertical start position)
- V ACTIVE  
(Vertical active area)

**PICTURE ADJUSTMENT** P.124

(Picture controls)

- OUTPUT BRIGHTNESS  
(Output brightness)
- OUTPUT CONTRAST  
(Output contrast)
- OUTPUT GAMMA  
(Output gamma)
- OUTPUT SETTING INIT.  
(Output video correction initialization)
- INPUT SHARPNESS  
(Input sharpness)
- INPUT BRIGHTNESS  
(Input brightness)
- INPUT CONTRAST  
(Input contrast)
- INPUT HUE  
(Input hue)
- INPUT SATURATION  
(Input saturation)
- INPUT SETTING INIT.  
(Input video correction initialization)

**OUTPUT AUDIO SETTINGS** P.127

(Output audio)

- MUTE  
(Mute)
- LIP SYNC  
(Output Lip Sync)
- EMBEDDED  
(Audio embedding)
- DE-EMBEDDED  
(Audio de-embedding)
- AUDIO OUT SELECT  
(Audio setting)
- SDI AUDIO GROUP  
(SDI output audio group)

**INPUT AUDIO SETTINGS** P.131

(Input audio)

- STABLE WAIT  
(Stable audio input wait)
- SDI AUDIO GROUP  
(SDI input audio group)

**EDID SETTINGS** P.131

(EDID)

- RESOLUTION  
(Resolution)
- SINK DEVICE EDID COPY  
(Copying EDID)
- CH. FOR EXTERNAL MODE  
(External EDID)
- SIGNAL FORMAT  
(HDMI/DVI)
- FRAME RATE  
(Frame rate)
- DEEP COLOR  
(Deep Color)
- Linear PCM  
(LPCM audio)
- AAC  
(AAC audio)
- Dolby Digital  
(Dolby Digital audio)
- Dolby Digital Plus  
(Dolby Digital Plus audio)
- Dolby TrueHD  
(Dolby TrueHD audio)
- DTS  
(DTS audio)
- DTS-HD  
(DTS-HD audio)
- SPEAKER CONFIGURATION  
(Speaker configuration)

**RS-232C SETTINGS** P.141

(RS-232C)

- PARAMETERS  
(RS-232C communication)

LAN SETTINGS P.141

- (LAN)
  - IP ADDRESS (IP address)
  - SUBNET MASK (Subnet mask)
  - GATEWAY ADDRESS (Gateway address)
  - MAC ADDRESS (MAC address)
  - PORT NUMBER (TCP port number)
  - OUTPUT LAN THROUGH (Output LAN of extension connector)
  - INPUT LAN THROUGH (Input LAN of extension connector)
  - OUTPUT SDVoE DETECTION (Sending SDVoE device detection packet (Output))
  - INPUT SDVoE DETECTION (Sending SDVoE device detection packet (Input))
  - AUTO DISCONNECT (Automatic disconnection time (Timeout))

USER PRESET P.144

- (Preset memory)
  - RECALL CROSSPOINT (Recalling crosspoint)
  - STORE CROSSPOINT (Saving crosspoint)
  - EDIT CROSSPOINT (Editing crosspoint)
  - RECALL PRESET SETTINGS (Recalling preset memory)
  - STORE PRESET SETTINGS (Saving preset memory)
  - START-UP (Start-up setting)

BITMAP P.148

- (Bitmap)
  - BITMAP OUTPUT (Bitmap image output)
  - BACKGROUND COLOR (Background color)
  - ASPECT RATIO (Aspect ratio)
  - IMAGE POSITION (Image position)
  - START-UP BITMAP (Start-up bitmap output)
  - MEMORY MODE (Memory mode of bitmap file)

MULTI WINDOW P.154

- (Multi window output)
  - WINDOW POSITION (Window position)
  - WINDOW SIZE (Window size)
  - ASPECT RATIO WINDOW SIZE (Aspect Ratio)
  - IMAGE POSITION (Image position)
  - IMAGE SIZE (Image size)
  - BACKGROUND COLOR (Window background color)
  - WINDOW PRIORITY (Window layer order)
  - VIDEO SWITCHING EFFECT (Window transition effect)
  - WINDOW ENABLE (Window ON/OFF)
  - OVERLAY TEXT POSITION (Overlay text position)
  - OVERLAY TEXT SIZE (Overlay text size)
  - BORDER SIZE (Window border size)
  - BORDER COLOR (Window border color)
  - VIDEO SYNC PROCESSING BORDER COLOR (Window video synchronizationWindow border color)
  - RECALL PATTERN (Recalling multi window memory)
  - STORE PATTERN (Saving multi window memory)

SYSTEM SETTINGS P.165

- (Configuring FDX-S)
  - BUTTON LOCK TARGET (Grouping front panel security lockout)
  - BEEP SOUND (Beep)
  - ALARM (Alarm)
  - ADVANCED MENU (Displaying advanced menu)
  - POWER SAVE MODE (Power saving)
  - TOP PAGE (Top page)
  - SELECT MODE (Channel selection mode)

## VIEW STATUS P.173

(Status indication)

— INPUT STATUS

(Input signal status)

— SINK DEVICE STATUS

(Sink device status)

— SINK DEVICE EDID

(Viewing sink device EDID)

— SYSTEM STATUS

(System status)

— BOARD STATUS

(Viewing board status)

— FAN STATUS

(Fan status)

— POWER STATUS

(Power supply voltage status)

— VERSION

(Device information)

## 10.3 Displaying crosspoint

---

Menu   Top→CROSS POINT→VIEW SELECTED CHANNELS

You can view crosspoint of input and output channels.

OFF: No channel is selected.

【See: 9.2.2 Selecting output video】

OUTPUT>	01	02	03	04
INPUT >	01	OFF	OFF	16↕

**[Fig. 10.1] Displaying selected I/O channels**

## 10.4 Output position, size, and masking

### 10.4.1 Output resolution

Scan conversion output only

Menu Top→OUTPUT IMAGE→RESOLUTION

Setting for CH01 to CHn

Setting value

- AT [Default]
- 4096x2160 60Hz\*
- 4096x2160 59.94Hz\*
- 4096x2160 50Hz\*
- 4096x2160 30Hz\*
- 4096x2160 29.97Hz\*
- 4096x2160 25Hz\*
- 4096x2160 24Hz\*
- 4096x2160 23.98Hz\*
- 2160p 60Hz (3840x2160)\*
- 2160p 59.94Hz (3840x2160)\*
- 2160p 50Hz (3840x2160)\*
- 2160p 30Hz (3840x2160)\*
- 2160p 29.97Hz (3840x2160)\*
- 2160p 25Hz (3840x2160)\*
- 2160p 24Hz (3840x2160)\*
- 2160p 23.98Hz (3840x2160)\*
- 1080p 60Hz
- 1080i 60Hz
- 720p 60Hz
- 1080p 59.94Hz
- 1080p 50Hz
- 1080i 59.94Hz
- 1080i 50Hz
- 720p 59.94Hz
- 720p 50Hz
- 576p 50Hz
- 480p 59.94Hz
- WQXGA (2560x1600)\*
- WQHD (2560x1440)\*
- QWXGA (2048x1152)
- WUXGA (1920x1200)
- VESAHD (1920x1080)
- WSXGA+ (1680x1050)
- UXGA (1600x1200)
- WXGA++ (1600x900)
- WXGA+ (1440x900)
- SXGA+ (1400x1050)
- WXGA (1366x768)
- WXGA (1360x768)
- SXGA (1280x1024)
- Quad-VGA (1280x960)
- WXGA (1280x800)
- WXGA (1280x768)
- XGA (1024x768)
- VGA (640x480)

\*Selectable for 4K@60 scan conversion output board and 4K@60 scan conversion multiview output board

You can set the output resolution.

If selecting "AT", the optimal resolution will be selected automatically. The current output resolution is displayed on the front display.

PC resolutions (XGA, WXGA, QWXGA, and others) support 60 Hz.

480p/576p/720p/1080i/1080p/2160p/4096x2160 are timing formats relating to the CTA-861 standard while output timings of other resolutions meet VESA DMT or VESA CVT.

VESAHD, WUXGA, QWXGA, WQHD, and WQXGA are output formats that incorporate Reduced Blanking.

Press the "MENU/ENTER" button to apply the setting.

### 10.4.2 Aspect ratio for sink device

Scan conversion output only

Menu	Top→OUTPUT IMAGE→ASPECT RATIO		
Setting for	OUT01 to OUTn		
Setting value	<ul style="list-style-type: none"> <li>• RESOLUTION* [Default]</li> <li>• 5:4</li> </ul>	<ul style="list-style-type: none"> <li>• 256:135</li> <li>• 5:3</li> </ul>	<ul style="list-style-type: none"> <li>• 16:10</li> <li>• 4:3</li> <li>• 16:9</li> </ul>

\* If you select “RESOLUTION”, the aspect ratio of the output resolution will be applied. If aspect ratios of the target sink device and the output resolution are different from each other, you can select one of the following aspect ratios for the sink device: “4:3”, “5:3”, “5:4”, “16:9”, “16:10”, and “256:135”.

【See: 10.4.1 Output resolution】

### 10.4.3 Image position

Scan conversion output only

Menu	Top→OUTPUT IMAGE→IMAGE POSITION		
Setting for	CH01 to CHn		
Setting value	Horizontal position : -2100.0% to +2100.0% [by 0.1%] [Default] 0.0% Vertical position : -2100.0% to +2100.0% [by 0.1%] [Default] 0.0% By 0.1% from the front menu By 0.01% from the WEB browser and command		

The image position is based on the output resolution (100%), and it starts from the upper left quadrant.

Images move to as below:

Setting + values : Rightward and downward

Setting – values : Leftward and upward

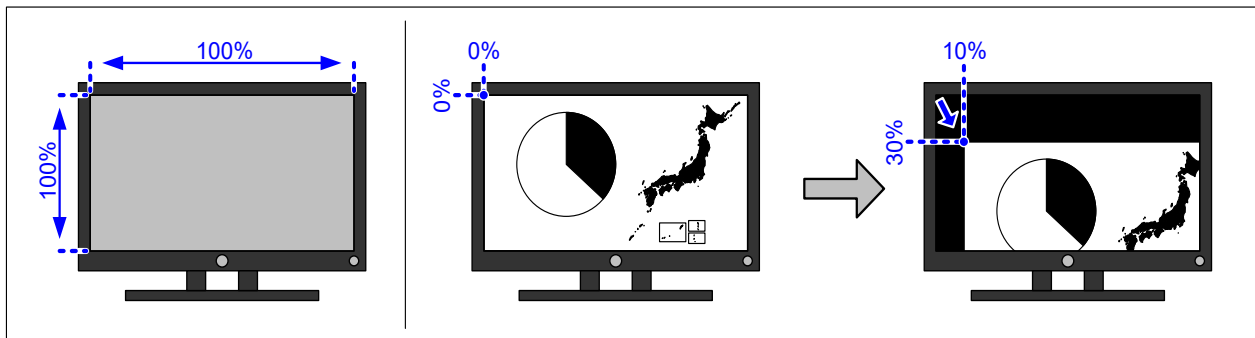

【Fig. 10.2】 Image position

The image position is automatically set when videowall position is set. If you want to adjust the image position after the videowall position is set, use this menu.

【See: 10.4.8 Videowall position】

## 10.4.4 Image size

Scan conversion output only

Menu	Top→OUTPUT IMAGE→IMAGE SIZE
Setting for	CH01 to CHn
Setting value	Horizontal size : 20.0% to 2100.0% [by 0.1%] [Default] 100.0% Vertical size : 20.0% to 2100.0% [by 0.1%] [Default] 100.0% By 0.1% from the front menu By 0.01% from the WEB browser and command

You can set the image size of output video.

The image size is based on the output resolution (100%), and it starts from the set image position.

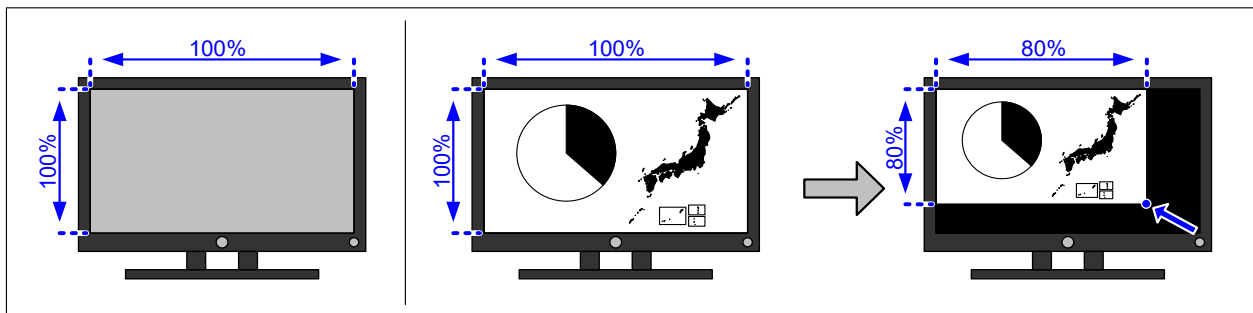

**[Fig. 10.3] Image size**

The image size is automatically set when videowall is set. If you want to adjust the image size after the videowall is set, use this menu.

**【See: 10.4.7 Videowall configuration】**

**Note:**

If the horizontal pixel of “**10.4.1 Output resolution**” is set to 2560 pixels or larger and the horizontal size is set to 1200.0% or higher, an input video signal with a pixel count of less than 1400 pixels may not be displayed correctly.

### 10.4.5 Background color

Scan conversion output only

Menu	Top→OUTPUT IMAGE→BACKGROUND COLOR
Setting for	ALL, OUT01 to OUTn
Setting value	R/G/B: 0 to 255 [Default] R/G/B: 0 (Black)

You can set the background color of output video signal.  
 Select “A” to change the settings of “R”, “G” and “B” relatively from the current setting values.



[Fig. 10.4] Background color

### 10.4.6 Test pattern

Scan conversion output only

Menu	Top→OUTPUT IMAGE→TEST PATTERN
Setting for	OUT01 to OUTn
Setting value	

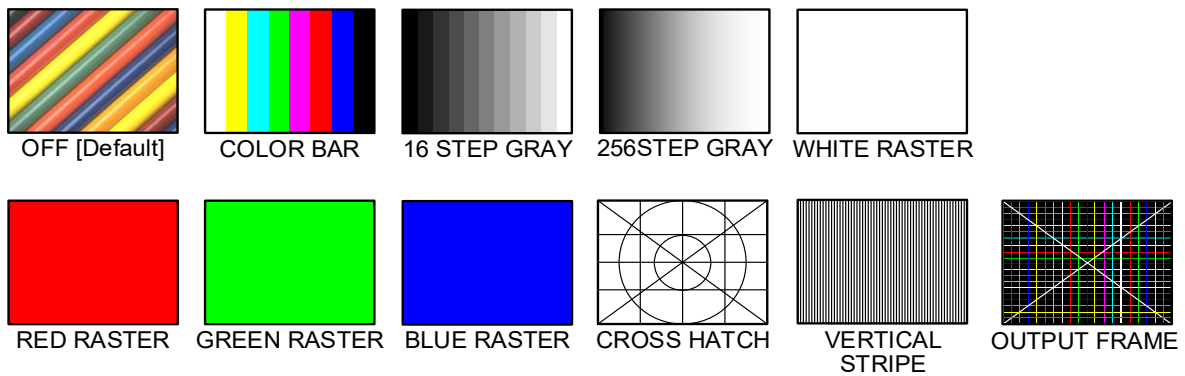

[Fig. 10.5] Test pattern

You can activate the FDX-S’s internal test pattern generator and direct its signal to each output connector.  
 “OUTPUT FRAME”: A test pattern for videowall configuration. This pattern is linked to image position, image size, videowall configuration, and videowall position settings.

For test patterns other than “OUTPUT FRAME”: Video is output on full screen with the resolution format as set in Output resolution and the settings of Image position, and Image size will be invalid.

【See: 10.4.1 Output resolution】

【See: 10.4.7 Videowall configuration】

【See: 10.4.8 Videowall position】

【See: 10.4.3 Image position】

【See: 10.4.4 Image size】

## 10.4.7 Videowall configuration

Scan conversion output only

Menu	Top→OUTPUT IMAGE→VIDEO WALL TYPE
Setting for	OUT01 to OUTn
Setting value	H: -- (Not control), 01 to 20 (The number of horizontal screens : 1 to 20) [Default] 01 V: -- (Not control), 01 to 20 (The number of vertical screens : 1 to 20) [Default] 01

You can set the videowall layout.

Press the “MENU/ENTER” button to apply the setting.

Once setting is reset, image size is automatically set based on the set number of windows. If you want to keep the image size settings, select “-- (Not control)”. Image position and videowall position settings are not reset automatically.

【See: 10.4.8 Videowall position】

【See: 10.4.3 Image position】

【See: 10.4.4 Image size】

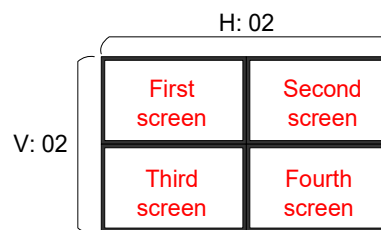

【Fig. 10.6】 2×2 videowall

### Note:

If the horizontal pixel of “**10.4.1 Output resolution**” is set to 2560 pixels or larger and the horizontal videowall type is set to 12 or more, the input video with horizontal pixel smaller than 1400 pixels may not be displayed correctly.

### 10.4.8 Videowall position

Scan conversion output only

Menu	Top→OUTPUT IMAGE→VIDEO WALL POSITION
Setting for	OUT01 to OUTn
Setting value	H: -- (Not control), 01 to 20 (Horizontal display position : First to 20th from left) [Default] 01 V: -- (Not control), 01 to 20 (Vertical display position : First to 20th from top) [Default] 01

You can set the horizontal and vertical display positions.  
Press the “MENU/ENTER” button to apply the setting.

Once setting is reset, settings of “10.4.3 Image position” are automatically set based on the set number of screens. If you want to keep the image position settings, select “-- (Not control)”. Image size and videowall configuration settings are not reset.

【See: 10.4.7 Videowall configuration】  
【See: 10.4.4 Image size】

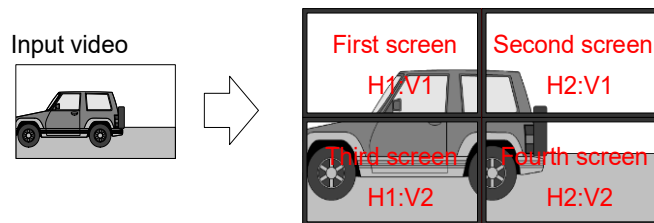

[Fig. 10.7] 2x2 videowall (Example: 4 screens)

### 10.4.9 Frame delay

Scan conversion output only

Menu	Top→OUTPUT IMAGE→VIDEO FRAME DELAY
Setting for	ALL, OUT01 to OUTn
Setting value	OFF: No frame delay [Default] 1 : 1 frame delay -1 : -1 frame delay

You can set the frame delay for videowall.  
The frame delay function avoids time lag that occurs between upper and lower screens.

For three or more rows of screens:  
If the resolution or frame rate of I/O signals is not the same, this function cannot correct the time lag. In this case, set this menu to “OFF” and use the reverse scan function or the like of the monitors to correct the time lag.

For four or more rows of screens:  
The frame delay function cannot correct the time lag. Use the reverse scan function or the like of the monitors to correct the time lag.

## 10.4.10 Synchronization mode

Scan conversion output only

Menu	Top→OUTPUT IMAGE→VIDEO SYNC MODE
Setting for	SLOT01 to SLOTm
Setting value	<ul style="list-style-type: none"> <li>• THROUGH : Operated with synchronous signal created in inside board [Default]</li> <li>• FOLLOWER : Follows the upper master synchronous signal.</li> <li>• LEADER A : Synchronous signal of connector A is the master.</li> <li>• LEADER B : Synchronous signal of connector B is the master.</li> <li>• LEADER C : Synchronous signal of connector C is the master.</li> <li>• LEADER D : Synchronous signal of connector D is the master.</li> </ul> <p>* Selectable for 4K@60 scan conversion output board and 1080p scan conversion output board</p>

You can set the board synchronization mode.

The reference synchronous signal is routed to lower board from the “LEADER” board.

Set this menu to “FOLLOWER” for the board to be synchronized to the reference signal while setting this menu to “THROUGH” for the board not to be synchronized.

For “FOLLOWER” and “THROUGH”, the reference synchronous signal is transmitted to lower board in unchanged form.

For boards that are not configured in the videowall, set this menu to “THROUGH”.

“LEADER” can be set for several boards. “LEADER” boards do not use the reference synchronous signal that is from an upper board. For “FOLLOWER” or “THROUGH” boards, the synchronous signal of the first upper “LEADER” board is the reference synchronous signal. For details, see “**10.4.11 Video synchronization**”.

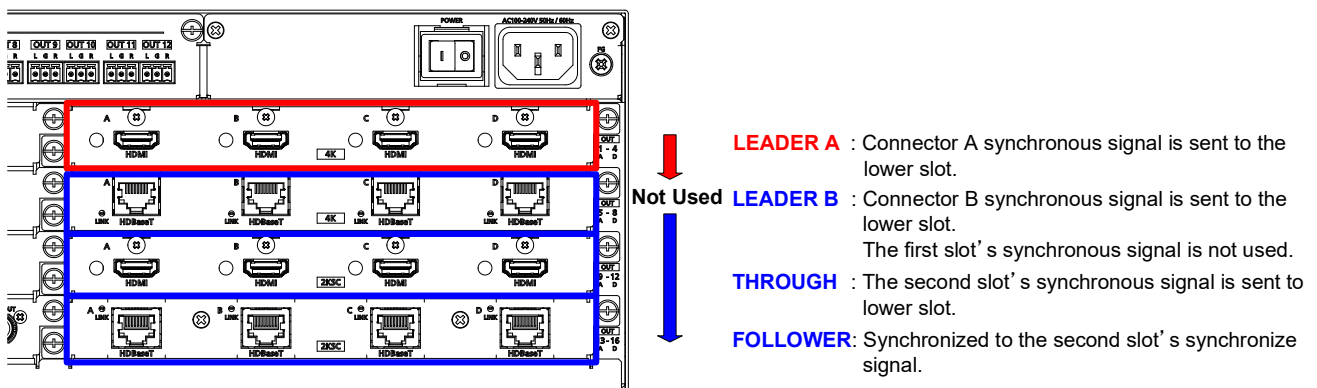

[Fig. 10.8] Sending synchronous signal

Set synchronization of each output channel in the video synchronization menu.

Set the same output resolution for output channels to be synchronized. If they are not the same, video cannot be synchronized. Even if their resolutions are the same, some boards cannot be synchronized.

【See: 10.4.1 Output resolution】

### 10.4.11 Video synchronization

Scan conversion output only

Menu Top→OUTPUT IMAGE→VIDEO SYNC PROCESSING  
 Setting for ALL, OUT01 to OUTn  
 Setting value OFF [Default], ON

Set the same output resolution between output channels to be synchronized. If they are not the same, video cannot be synchronized. Even if their resolutions are the same, some boards cannot be synchronized.

【See: 10.4.1 Output resolution】

■ The following scan conversion boards can be synchronized:

- ① 1080p HDMI/DVI scan conversion (FDX-SOV4HS)
- ② 1080p HDBaseT scan conversion (FDX-SOV4TS)
- ③ 4K@60 HDMI/DVI scan conversion (FDX-SOV4UHS, FDX-SOV2UHS)
- ④ 4K@60 HDMI/DVI scan conversion multiview (FDX-SOV1UHM)

**[Table 10.2] Board combinations**

LEADER THROUGH FOLLOWER	① (FDX-SOV4HS)	② (FDX-SOV4TS)	③ (FDX-SOV4UHS, FDX-SOV2UHS)	④ (FDX-SOV1UHM)
① (FDX-SOV4HS)	Can be synchronized	Can be synchronized	Cannot be synchronized	Cannot be synchronized
② (FDX-SOV4TS)	Can be synchronized	Can be synchronized	Cannot be synchronized	Cannot be synchronized
③ (FDX-SOV4UHS, FDX-SOV2UHS)	Cannot be synchronized	Cannot be synchronized	Can be synchronized	Cannot be synchronized
④ (FDX-SOV1UHM)	Cannot be synchronized	Cannot be synchronized	Cannot be synchronized	Can be synchronized

Since output boards other than above ① to ④ boards do not include scan conversion feature, these boards only transmit synchronous signal to the next board below (“THROUGH” only).

■ **Setting example**

Videowall with eight screens (Example: 2×2 and 4×2)

**[Table 10.3] Synchronization (Example: 2×2 and 4×2)**

Setting item	Setting for	2×2	4×2
Synchronization mode	SLOT03	LEADER B	LEADER A
	SLOT04	FOLLOWER	FOLLOWER
Video synchronization	OUT09	OFF	ON
	OUT10	ON	ON
	OUT11	ON	ON
	OUT12	OFF	ON
	OUT13	OFF	ON
	OUT14	ON	ON
	OUT15	ON	ON
	OUT16	OFF	ON

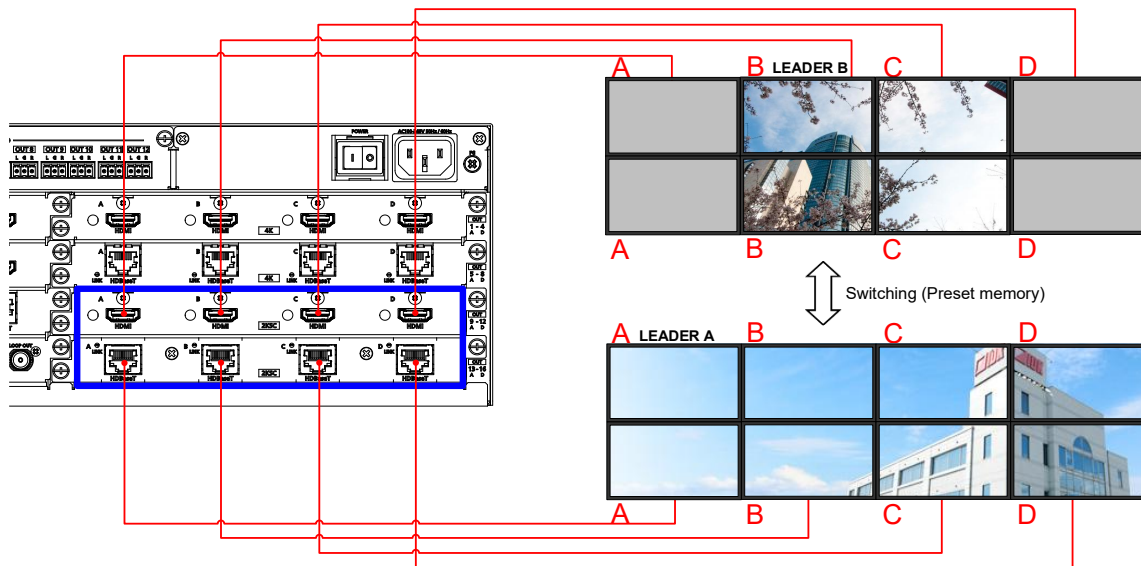

**[Fig. 10.9] Synchronization (Example: 2×2 and 4×2)**

- For 2×2, SLOT03-B (OUT10) is the reference synchronous signal.
- For 4×2, SLOT03-A (OUT09) is the reference synchronous signal.
- Output video signal with “ON” setting is synchronized.

The example below shows two separate videowall configurations at the same time.

**[Table 10.4] Synchronization (Example: Two 4×2 videowall)**

Setting item	4×2 videowall (1)		4×2 videowall (2)	
	Setting for	Setting value	Setting for	Setting value
Synchronization mode	SLOT01	LEADER A	SLOT07	LEADER A
	SLOT02	FOLLOWER	SLOT08	FOLLOWER
Video synchronization	OUT01	ON	OUT25	ON
	OUT02	ON	OUT26	ON
	OUT03	ON	OUT27	ON
	OUT04	ON	OUT28	ON
	OUT05	ON	OUT29	ON
	OUT06	ON	OUT30	ON
	OUT07	ON	OUT31	ON
	OUT08	ON	OUT32	ON

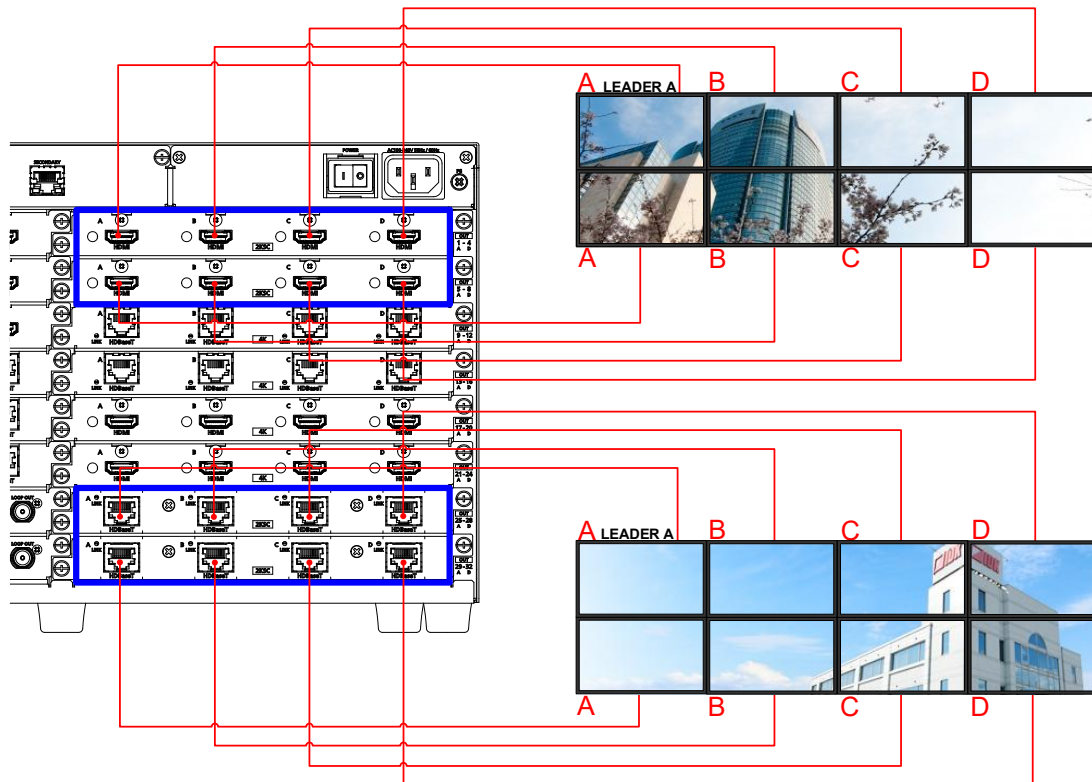

**[Fig. 10.10] Synchronization (Example: Two 4×2 videowall)**

For 4×2 videowall (1), SLOT01 and SLOT02 output signals are synchronized by following SLOT01-A (OUT01) that is the reference synchronous signal.

For 4×2 videowall (2), SLOT07 and SLOT08 output signals are synchronized by following SLOT07-A (OUT25) that is the reference synchronous signal.

The example below shows the case a board that is not included in the videowall configuration is installed between two videowall configuration boards.

**[Table 10.5] Synchronization setting (4×2)**

Setting item	Setting for	Setting value
Synchronization mode	SLOT01	LEADER A
	SLOT02	THROUGH
	SLOT03	THROUGH
	SLOT04	FOLLOWER
Video synchronization	OUT01	ON
	OUT02	ON
	OUT03	ON
	OUT04	ON
	OUT05 – OUT12	OFF
	OUT13	ON
	OUT14	ON
	OUT15	ON
OUT16	ON	

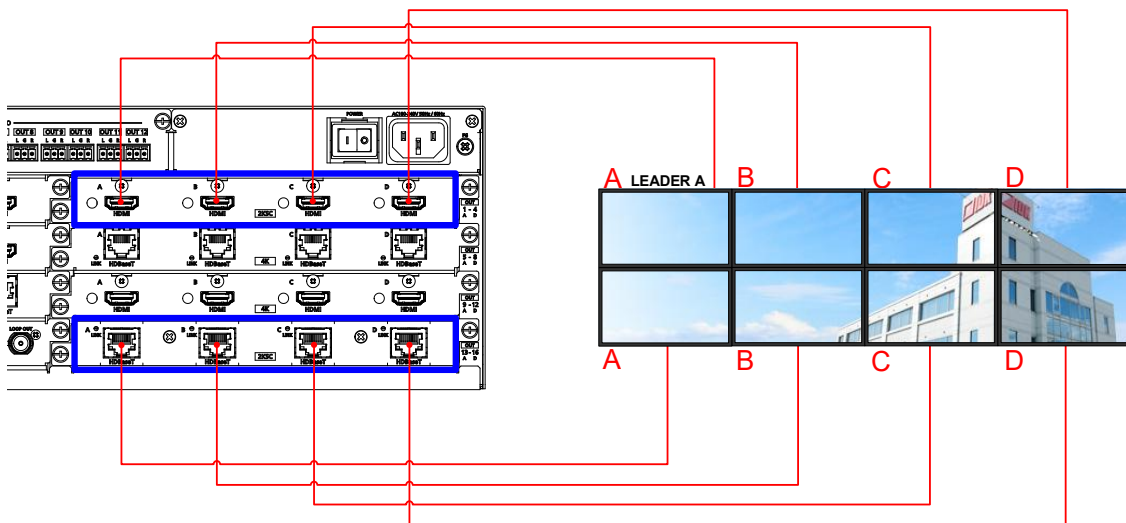

**[Fig. 10.11] Synchronization setting (4×2)**

SLOT01-A (OUT01) is the reference synchronous signal, and the signal is transmitted to SLOT04 through SLOT02 and SLOT03. Make sure to set “**10.4.10 Synchronization mode**” to “THROUGH” for scan converter output boards are installed to SLOT02 and SLOT03. If boards other than scan converter output boards are installed to SLOT02 and SLOT03, it is set to THROUGHT” automatically.

The example below shows the case 2×2 videowall is configured using two output boards with 4K@60 scan converter.

[Table 10.6] Synchronization (2×2 videowall by two output boards with 4K@60 scan converter)

Setting item	Setting for	Setting value
Synchronization mode	SLOT03	LEADER A
	SLOT04	FOLLOWER
Video synchronization	OUT09	ON
	OUT10	ON
	OUT13	ON
	OUT14	ON

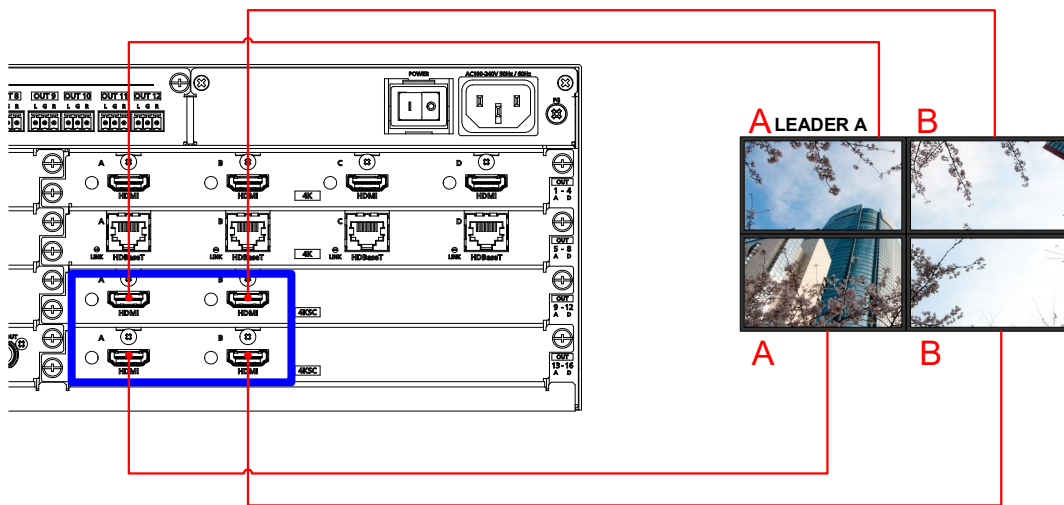

[Fig. 10.12] Synchronization (2×2 videowall by two output boards with 4K@60 scan converter)

SLOT03 and SLOT04 output is synchronized following SLOT03-A (OUT9).

For a 4K@60 scan conversion output board, two boards are used for 2×2 videowall.

A 4K@60 scan conversion multiview output board is synchronized to the same window numbers (A to D) of the “LEADER” board.

【See: 10.17 Multi window output】

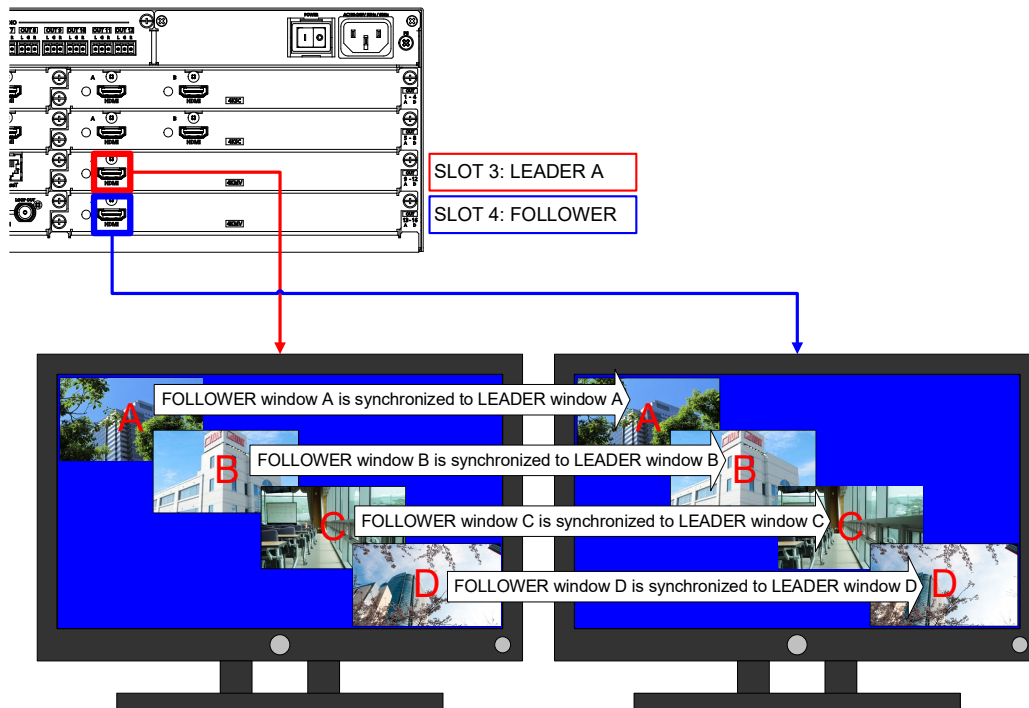

[Fig. 10.13] Synchronization (Multi window)

For multi window videowall, channels (A to D) to be synchronized should be the same among the slots.

Example:

- An image (A) is displayed on all four windows.
- An image (C) is displayed on the lower left half and lower right half windows.

Set the synchronization mode as follows:

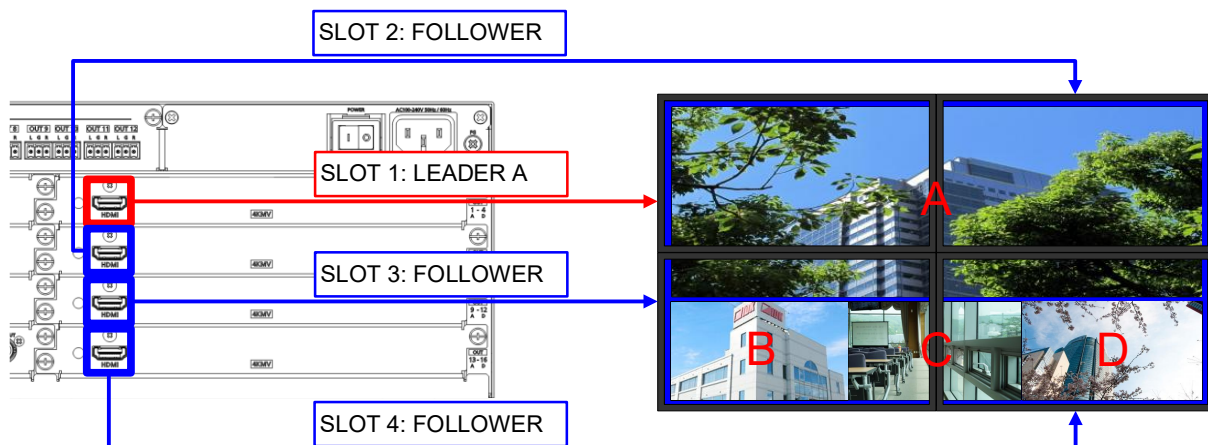

[Fig. 10.14] Multi window synchronization

Synchronizable board combinations may not be synchronized depending on board configuration.  
 Example: 4K@60 scan conversion output board and 4K@60 scan conversion multiview output board are included in a configuration

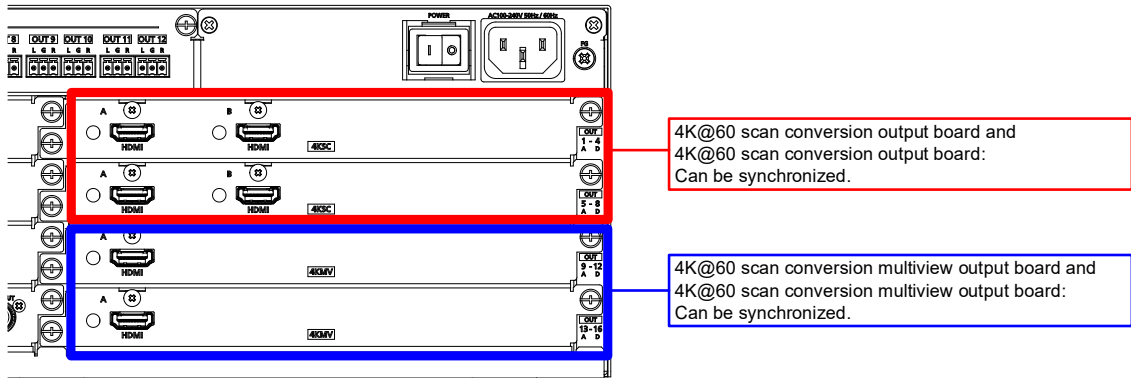

[Fig. 10.15] Example (Can be synchronized)

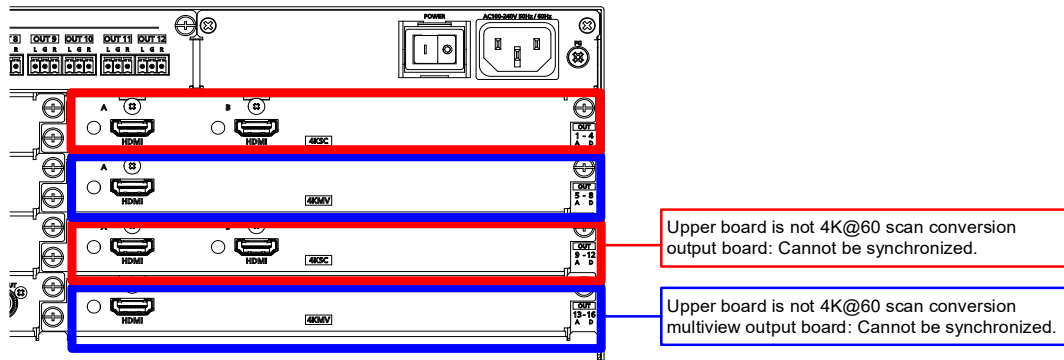

[Fig. 10.16] Example (Cannot be synchronized)

In the example above, by setting the second board (4K@60 scan conversion multiview output board) to “THROUGH”, the top board and the third board (4K@60 scan conversion output boards) can be synchronized. Also, by setting the third board (4K@60 scan conversion output board) to “THROUGH”, the second board and the fourth board (4K@60 scan conversion multiview output board) can be synchronized.

## 10.5 Output

---

### 10.5.1 Disabling synchronous signal output when no video signal is input

Menu	Top→OUTPUT SETTINGS→SYNC. SIGNAL OUTPUT	Scan conversion output only
Setting for	ALL, OUT01 to OUTn	
Setting value	OFF [Default], 5 Sec to 60 Sec	

You can set the waiting time to stop outputting video signals for when no video signal is input to a selected input channel or input channel selection is set to "OFF".

For 4K@60 scan conversion multiview output board, "5 Sec to 60 Sec" setting is enabled if video signals are not input to all windows (A to D) or "OFF" is set to the input channel selection.

### 10.5.2 Output video for when no input video

Scan conversion output only

Menu	Top→OUTPUT SETTINGS→NO SIGNAL IMAGE
Setting for	ALL, OUT01 to OUTn
Setting value	BACK COLOR [Default], BITMAP1 to BITMAP4

You can set video to be output when no video signal is being presented to the selected input.

To enable this function, set "**10.5.1 Disabling synchronous signal output when no video signal is input**" to OFF.

Unregistered bitmap number cannot be selected.

4K@60 scan conversion multiview output board cannot be set. The background of the window is output.

【See: 10.4.5 Background color】

【See: 10.16 Bitmap】

【See: 10.17.6 Window background color】

### 10.5.3 HDCP output

Scan conversion output only

Menu Top→OUTPUT SETTINGS→HDCP OUTPUT MODE

Setting for OUT01 to OUTn

Setting value

[Table 10.7] HDCP output mode

Setting value	Description
HDCP 2.2 [Default for 4K@60 scan conversion output board and 4K@60 scan conversion multiview output board]	Encrypts HDCP 2.2 preferentially
HDCP 1.4 [Default for 1080p scan conversion output board]	Encrypts HDCP 1.4
HDCP INPUT ONLY	Encrypts HDCP only if the input signal has HDCP. However, if an input is changed from one channel to another and HDCP authentication status is changed, the FDX-S starts HDCP authentication again. This action may temporarily delay the output of video and audio.
HDCP DISABLE	Does not encrypt HDCP. Only non-HDCP-compliant input signal can be output.

"HDCP 2.2" cannot be selected for 1080p scan conversion output board.

You can set the HDCP output for when an HDCP-compliant sink device is connected.

## 10.5.4 Output equalizer

1080p HDMI/DVI scan conversion output only

Menu Top→OUTPUT SETTINGS→SIGNAL EQUALIZATION

Setting for ALL, OUT01 to OUTn

Setting value

**[Table 10.8] Output equalizer setting**

Setting value	Equalization	Cable length*	
		Shorter than 33 ft. (10 m)	33 ft. (10 m) or longer
OFF [Default]	No equalization	✓	N/A
LOW	Low	✓	✓
MEDIUM	Middle	✓	✓
HIGH	High	N/A	✓

\* IDK's cable (24 AWG) was used

Each HDMI output connector includes an equalizer that compensates for signal attenuation when long HDMI cables are connected.

**Note:**

If a cable equalizer, active cable, or the like is connected, the FDX-S may not equalize output correctly. In such a case, set this menu to "OFF".

## 10.5.5 Output format

Boards other than 12G-SDI

Menu	Top→OUTPUT SETTINGS→SIGNAL FORMAT		
Setting for	OUT01 to OUTn		
Setting value	<ul style="list-style-type: none"> <li>• AUTO [Default]</li> <li>• HDMI 422</li> <li>• DVI</li> <li>• HDMI RGB</li> <li>• HDMI 444</li> <li>• HDMI 420*</li> </ul>		

\*Available only for 4K@60/59.94/50

You can select an output signal mode and color space of the output video.  
The selected mode has priority and is output to the sink device with the optimal mode.

### Notes:

- “HDMI 420” is only for 4K@60 output board.
- YCbCr 4:2:0 output is available only for 4K@50/59.94/60 output, for other resolution the format is set to “AUTO”.
- When 4K YCbCr 4:4:4 or 4K RGB 4:4:4 signal is input, the FDX-S outputs the signal at YCbCr 4:2:0 to the sink device supporting YCbCr 4:2:0 (not supporting YCbCr 4:4:4).
- For 4K@60 HDBaseT output board outputs at YCbCr 4:2:0 automatically, if 4K YCbCr 4:4:4 or 4K RGB 4:4:4 signal is input.
- For 4K YCbCr 4:2:0, only CTA-861 Video Format Timings are supported.
- For output boards other than scan conversion output board, DVI signal can be output if the input signal resolution is 4K@30 or less.
- For scan conversion output boards, DVI signal can be output if the output resolution is 4K@30 or less. With other resolutions, signal is output in the mode suitable for the sink device.
- If “DVI” is selected or DVI signal is output with “AUTO” setting, the assigned Dante or analog audio is not output.

【See: 10.10.3 Audio embedding】

## 10.5.6 Output RGB range

Scan conversion output only

Menu	Top→OUTPUT SETTINGS→RGB RANGE		
Setting for	ALL, OUT01 to OUTn		
Setting value	<ul style="list-style-type: none"> <li>• AUTO [Default]</li> <li>• FULL</li> <li>• LIMITED</li> </ul>		

You can set the RGB range.  
Clipped whites and black level problems may be solved by changing this setting.

## 10.5.7 HDBaseT output long reach mode

HDBaseT output only

Menu	Top→OUTPUT SETTINGS→HDBT LONG REACH MODE
Setting for	ALL, OUT01 to OUTn
Setting value	OFF: Long reach mode OFF Up to 328 ft. (100 m) [Default] ON : Long reach mode ON Up to 492 ft. (150 m)

You can enable/disable long reach mode for HDBaseT output.

With long reach mode, up to 1080p (24 bit)/dot clock 148 MHz is supported when using with IDK's HDBaseT product. Select a supported output format.

【See: 10.4.1 Output resolution】

【See: 10.5.8 Deep Color output】

## 10.5.8 Deep Color output

Boards other than 12G-SDI

Menu	Top→OUTPUT SETTINGS→DEEP COLOR
Setting for	OUT01 to OUTn
Setting value	24Bit [Default], 30Bit, 36Bit

You can select the color depth of HDMI signal.

“30bit” and 36Bit”: If signals are input with “30Bit” or “36Bit” and a sink device supporting Deep Color is connected, the signals are output at “30Bit” or “36Bit”, respectively. Since the transmission clock of “30Bit” and “36Bit” are faster than that of “24Bit”, noise may occur if a poor-quality cable or long cable is connected. In those cases, the noise may be removed by selecting “24Bit”.

Scan conversion output board outputs video signal with the set Deep Color regardless of the Deep Color of the input video signal.

1080p scan conversion output board supports up to “30Bit” Deep Color.

With 4K@60 scan conversion output board and 4K@60 scan conversion multiview output board, “24Bit” is supported for 4K@50/59.94 RGB/YCbCr 4:4:4, and “30Bit” is supported for other resolutions.

**10.5.9 Window transition effect**

Scan conversion output only

Menu Top→OUTPUT SETTINGS→VIDEO SWITCHING EFFECT

Setting for ALL, OUT01 to OUTn

Setting value

Setting value	Description
FADE OUT-IN [Default]	Transition effect is enabled; video is switched with FADE OUT-IN.
CUT	Transition effect is disabled; video is switched with CUT.
FREEZE (Only for FDX-SOV4UHS)	The previous video is frozen, and then the video is switched. If "Video synchronization" is set to "ON", "FADE OUT-IN" is applied. If "DDC power output when no signal is input" is set to "OFF", "CUT" is applied.

## 10.5.10 Sink device EDID check

Boards other than SDVoE and 12G-SDI

Menu	Top→OUTPUT SETTINGS→EDID ERR. OUTPUT MODE
Setting for	OUT01 to OUTn
Setting value	

**[Table 10.9] Sink device EDID check**

Setting value	Description
OFF [Default]	In case of error, treated as DVI
ERROR1	In case of error, treated as HDMI without SCDC
ALWAYS1	Treated as HDMI without SCDC all the time
ERROR2	In case of error, treated as HDMI with SCDC
ALWAYS2	Treated as HDMI with SCDC all the time

The FDX-S gets EDID from the sink device and determines if the sink device is an HDMI device or DVI device. However, if the FDX-S cannot get EDID for some reasons, problems such as no audio output and the like may occur.

“ERROR2” and “ALWAYS2” are only for 4K@60 output boards.

### Notes:

- For output boards with scan converter, this setting is applied when HDMI signal is input and “**10.5.5 Output format**” is set to a format other than DVI.
- For output boards other than scan conversion output board, this setting is applied when HDMI signal is input and “**10.5.5 Output format**” is set to a format other than DVI.
- For output boards other than scan conversion output board, if setting this menu to a value other than the “OFF”, set “**10.12.1 Resolution**” to a supported resolution other than External EDID.

【See: 10.5.5 Output format】

【See: 10.12.1 Resolution】

### 10.5.11 Hot plug ignoring duration

Boards other than SDVoE and 12G-SDI

Menu	Top→OUTPUT SETTINGS→HOTPLUG MASK
Setting for	ALL, OUT01 to OUTn
Setting value	OFF [Default], 2 Sec to 15 Sec

Time for ignoring the video output request signals sent from the sink device.  
 If the request signals are repeated in a short cycle, the FDX-S processes video output from the first cycle.  
 As a result, video may not be output. This problem can be solved by setting the ignoring time.

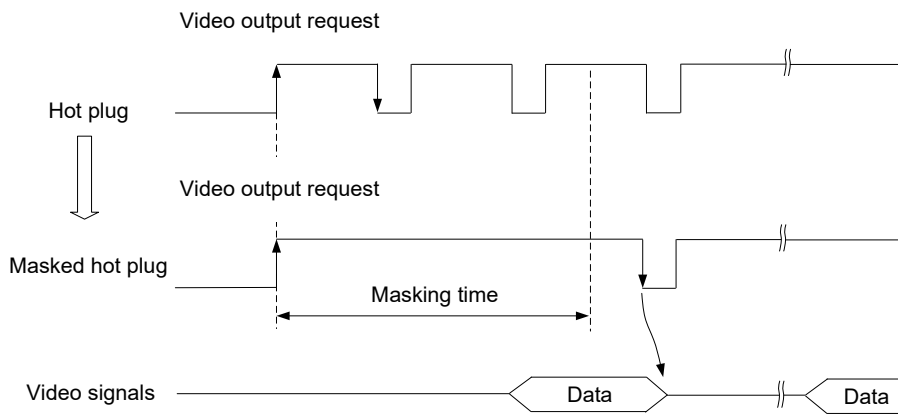
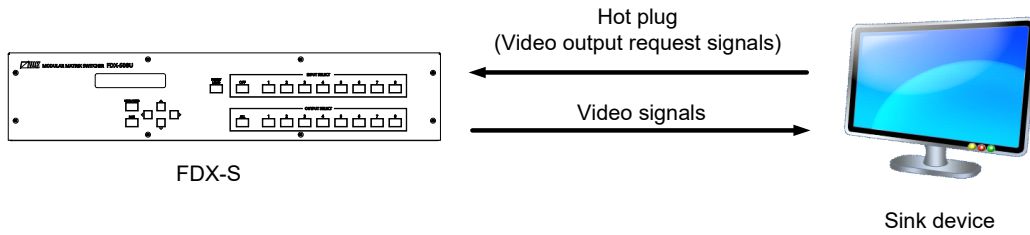

[Fig. 10.17] Hot plug mask

### 10.5.12 DDC power output when no signal is input

Boards other than SDVoE and 12G-SDI

Menu	Top→OUTPUT SETTINGS→DDC POWER OUT
Setting for	ALL, OUT01 to OUTn
Setting value	ON [Default], OFF

If setting to “ON”, the +5 V signal is output regardless of the presence of input signal, some sink devices are not in standby mode.  
 The “OFF” setting of the 4K@60 scan conversion multiview output board is enabled only if no video signal is input to all windows (A to D).

### 10.5.13 SDI output format conversion

12G-SDI output only

Menu Top→OUTPUT SETTINGS→SDI COLOR SPACE CONV.

Setting for OUT01 to OUTn

Setting value

**[Table 10.10] SDI output format**

Setting value	Description
OFF	Outputs color space as input color space.
ON [Default]	Converts to YCbCr 4:2:2 10 bit (standard format) and outputs.

You can set the color space of the SDI output signals.

**Note:**

If an HDMI/DVI input signal is output as an SDI signal with original color space, video may not be displayed correctly for some receivers.

### 10.5.14 SDI output gearbox mode

12G-SDI output only

Menu	Top→OUTPUT SETTINGS→SDI OUTPUT MODE
Setting for	SLOT01 to SLOTm
Setting value	SINGLE : Single link signal is output. [Default] DUAL 3G : 3G dual link signal is output.3G DUAL 6G : 6G dual link signal is output.6G QUAD 3G : 3G quad link signal is output.3G

If an input signal can be converted into multi link signal, the input signal can be output by setting the gearbox mode. For details, see “Input signals that support SDI output”.

[Table 10.11] SDI output gearbox mode: Connectors and number of outputs per slot

Gearbox mode	Connector	Output
SINGLE		4 outputs
DUAL 3G		2 outputs
DUAL 6G		2 outputs
QUAD 3G		1 output

The gearbox modes set output connectors and output signals such as output video selection and output setting.

The output video selection and output setting of each output connector may be changed depending on gearbox mode.

**[Table 10.12] Example: 12G-SDI output board is installed to SLOT1**

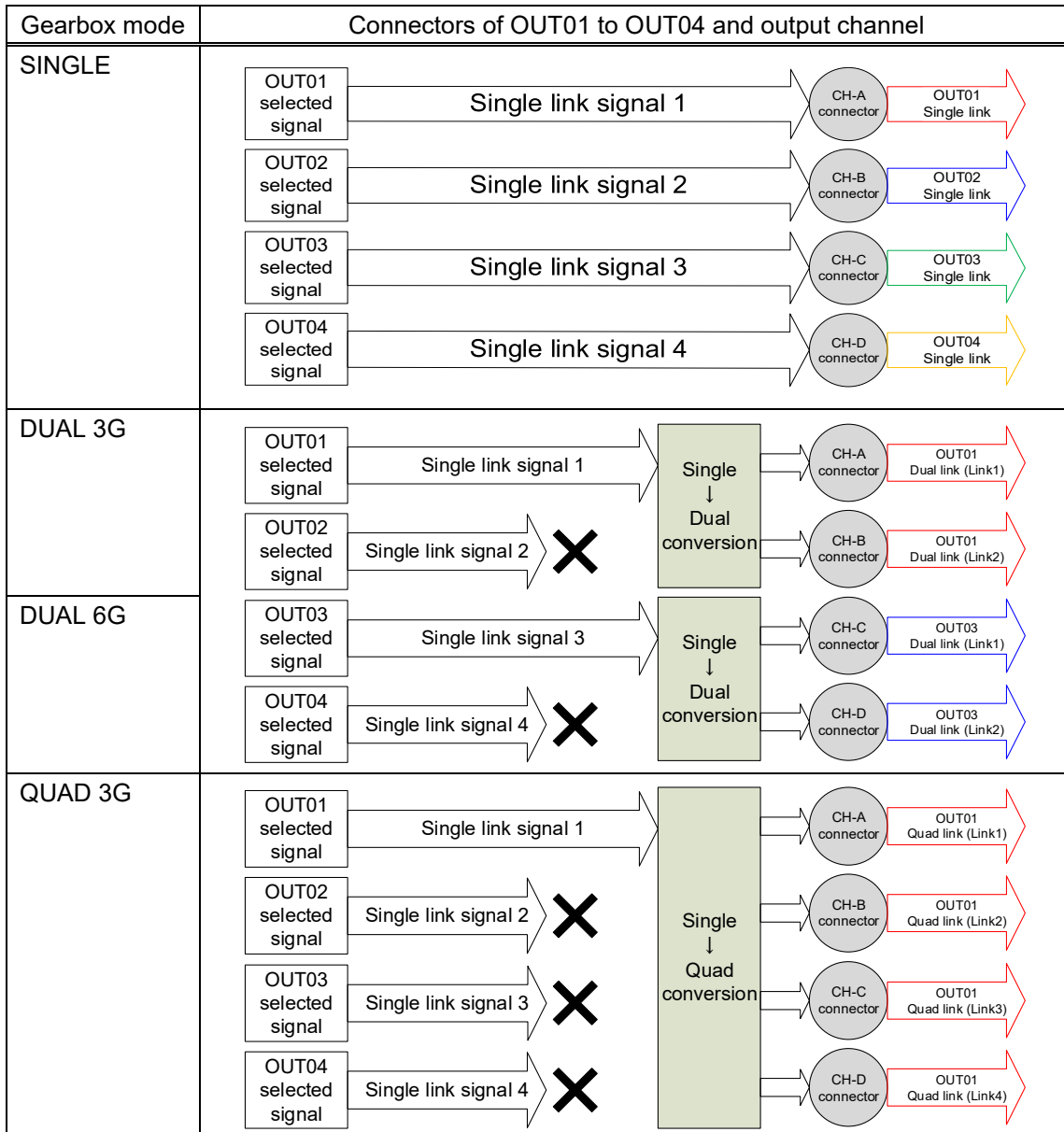

The following settings do not apply to output connectors or output signals:

- “DUAL 3G”/“DUAL 6G” is set to OUT02/OUT04
- “QUAD 3G” is set to OUT02 to OUT04

**Note:**

For multi link output settings ([DUAL 3G], [DUAL 6G], [QUAD 3G]), if signals that cannot be converted to multi link signals are input, no signal is output.

If multi link signals are not output, select [SINGLE] and check if signals that can be converted to multi link signals is output.

**[See: Input signals that support SDI output]**

### ■ Input signals that support SDI output

The following input signals can be output as SDI converted signals.

【See: 10.5.13 SDI output format conversion】

**[Table 10.13] Input signals supporting SDI output**

Input signal				Output signal	Multi link conversion
Resolution	Frame rate [Hz]	Color space (Sampling structure)	Color depth [bit]		
1280×720	25	YCbCr 4:2:2	24, 30	HD	Not supported
	50 60, 59.94	YCbCr 4:4:4 RGB	24, 30, 36	3G	Not supported
1920×1080	24, 23.98 25 30, 29.97	YCbCr 4:2:2	24, 30	HD	Not supported
			36	3G	Not supported
	48, 47.95 50 60, 59.94 (interlaced)	YCbCr 4:4:4 RGB	24, 30, 36	3G	Not supported
			24, 30	HD	Not supported
	48, 47.95 50 60, 59.94	YCbCr 4:2:2	36	3G	Not supported
			24, 30, 36	3G	Not supported
	48, 47.95 50 60, 59.94	YCbCr 4:4:4 RGB	24, 30	3G	Not supported
			36	6G	DUAL 3G
48, 47.95 50 60, 59.94	YCbCr 4:4:4 RGB	24, 30, 36	6G	DUAL 3G	
		24, 30	6G	DUAL 3G	
3840×2160 4096×2160	24, 23.98 25 30, 29.97	YCbCr 4:2:2	24, 30	6G	DUAL 3G
			36	12G	DUAL 6G QUAD 3G
	48, 47.95 50 60, 59.94	YCbCr 4:4:4 RGB	24, 30, 36	12G	DUAL 6G QUAD 3G
			24, 30	12G	DUAL 6G QUAD 3G
	48, 47.95 50 60, 59.94	YCbCr 4:2:0	24, 30	12G	DUAL 6G QUAD 3G
			24, 30	12G	DUAL 6G QUAD 3G

Input signals other than signals above are not output correctly.

For input signals with HDCP, output video is muted (black is output).

**Note:**

Input audio signal with sampling frequency other than 48 kHz is not output.

## 10.6 Input position, size, and cropping

### 10.6.1 Aspect ratio

Scan conversion output only

Menu Top→INPUT IMAGE→ASPECT RATIO

Setting for IN01 to INn for each input signal

Setting value

**[Table 10.14] Restoring aspect ratio (For input signal)**

Setting value	TV signal	PC signal
AUTO [Default]	Restores the aspect ratio based on the input signals by following the aspect ratio of the sink device automatically.	
FULL	Displays video on a full screen.	
4:3	4:3	Follows input signal aspect ratio
5:3	5:3	
5:4	5:4	
16:9	16:9	
16:10	16:10	
16:9 LT	16:9 LETTER BOX	

You can set the aspect ratio for each video input.

If no signal is input, "No Signal" is displayed on the front display.

【See: 10.4.2 Aspect ratio for sink device】

## 10.7 Input

### 10.7.1 No-signal input monitoring

Boards other than SDVoE and SDI

Menu	Top→INPUT SETTINGS→NO INPUT MONITORING
Setting for	ALL, IN01 to INn
Setting value	OFF, 3 Sec to 15 Sec (by 1Sec) [Default] 10 Sec

If you change the EDID settings of the FDX-S or power the FDX-S off/on, the source device may not output a video signal. Use this menu to set the monitoring time. This is the interval beginning when a source device is not outputting a signal; and ending at the point when the FDX-S requests an output from that source device.

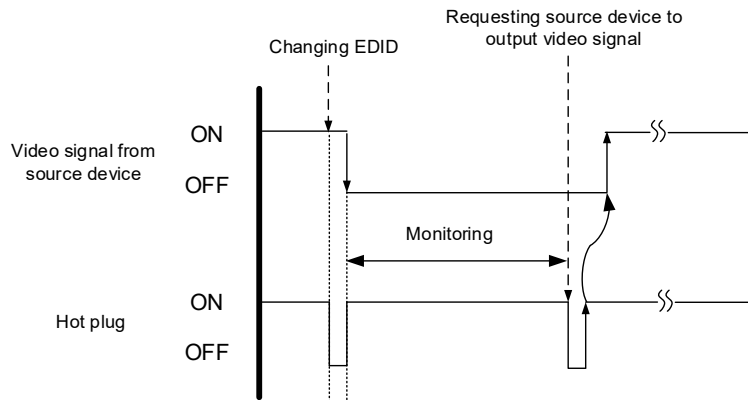

[Fig. 10.18] Monitoring absence of input

**Notes:**

- If you are using the monitor power-saving or dual monitor features on your PC, set this feature to “OFF”. This will avoid potentially unpredictable operation.
- When using this feature, ensure that the “monitoring time” is set for a value greater than the amount of time needed for the source to provide an output signal.

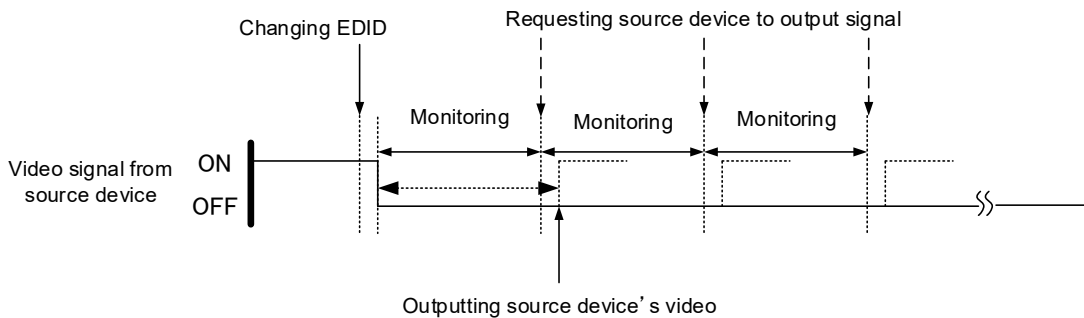

[Fig. 10.19] Repeating output reset

## 10.7.2 HDCP input

Boards other than SDI

Menu	Top→INPUT SETTINGS→HDCP INPUT MODE
Setting for	IN01 to INn
Setting value	HDCP 2.2 : Enabling HDCP 2.2 and HDCP 1.4 [Default] HDCP 1.4 : Enabling HDCP 1.4 DISABLE : Disabling HDCP

Some source devices negotiate with the connected device to determine if HDCP encryption is supported. After this negotiation, the source device determines whether HDCP signal encryption is enforced or not. This process takes place with some source device, even if the content being presented is not copyright protected. The FDX-S is HDCP compliant, if it is connected to a display device that does not support HDCP, even unprotected AV content may not be successfully displayed. Under these circumstances and if the content is indeed not protected, the problem can be solved by setting this menu to “DISABLE.”

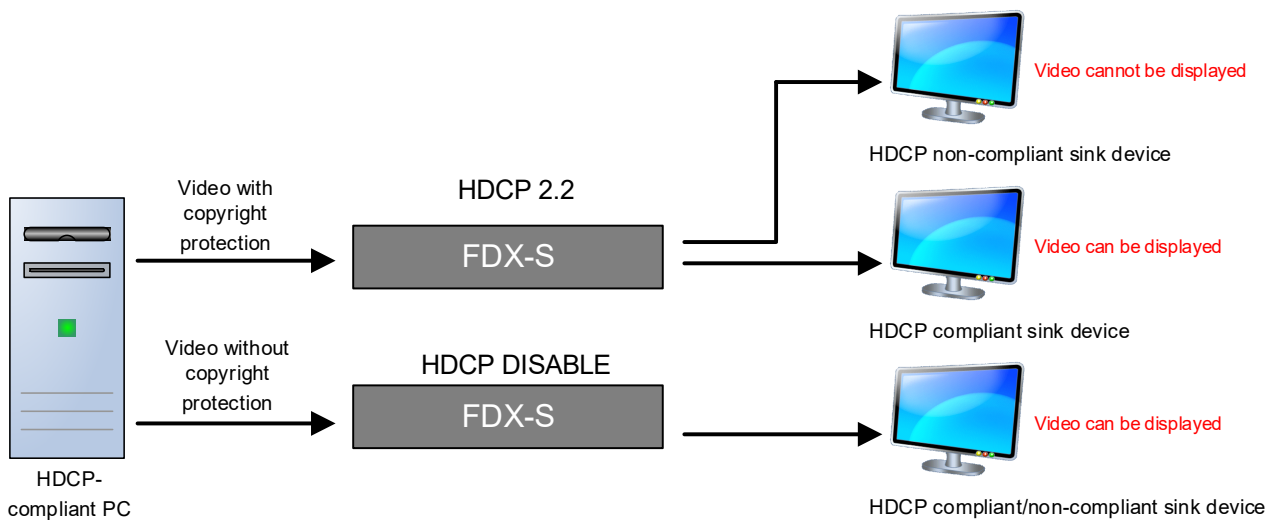

[Fig. 10.20] HDCP-compliant and HDCP non-compliant sink device

### Notes:

Set this setting to HDCP 2.2 or HDCP 1.4 in order to display video with copyright protection.

- HDCP 2.2 (stream type 0) contents can be displayed on sink devices supporting HDCP 2.2/HDCP 1.4.
- HDCP 2.2 (stream type 1) contents can be displayed on sink devices supporting HDCP 2.2 but cannot be displayed on sink devices supporting HDCP 1.4.

### 10.7.3 HDBaseT input long reach mode

HDBaseT input only

Menu	Top→INPUT SETTINGS→HDBT LONG REACH MODE
Setting for	ALL, IN01 to INn
Setting value	OFF: Long reach mode disabled. Up to 328 ft. (100 m) [Default] ON : Long reach mode enabled. Up to 492 ft. (150 m)

With long reach mode, up to 1080p (24 bit)/dot clock 148 MHz is supported when using with IDK's HDBaseT product. Set the FDX-S's EDID to 1080p or less or set the connected device's output to a supported signal format.

【See: 10.12.1 Resolution】  
【See: 10.12.6 Deep Color】

### 10.7.4 3G-SDI Dual Stream signal input

3G-SDI input only

Menu	Top→INPUT SETTINGS→3G-SDI DUAL STREAM
Setting for	IN01 to INn
Setting value	STREAM 1: Video stream 1 [Default] STREAM 2: Video stream 2

Two video streams are included when 3G-SDI Dual Stream signals are input. You can select one stream to be output.

### 10.7.5 SDI input gearbox mode

12G-SDI input only

Menu	Top→INPUT SETTINGS→SDI INPUT MODE
Setting for	SLOT01 to SLOTm
Setting value	FOLLOW PID : Determines automatically by CH-A input payload ID. SINGLE : Inputs single link signal. [Default] DUAL 3G : Inputs 3G dual link signal. DUAL 6G : Inputs 6G dual link signal. QUAD 3G : Inputs 3G quad link signal.

The multi link signals can be input by setting the gearbox mode. Connectors per input and the number of input channels per slot vary depending on the gearbox mode.

[Table 10.15] SDI input gearbox mode: Connectors and number of inputs per slot SDI

Gearbox mode	Connector	Input
SINGLE		4 inputs
DUAL 3G		2 inputs
DUAL 6G		
QUAD 3G		1 input

If an input number of a 12G-SDI input board is selected for crosspoint setting or the like, the following input numbers are selected.

**[Table 10.16] Input signal selection for when 12G-SDI input board is installed to SLOT1**

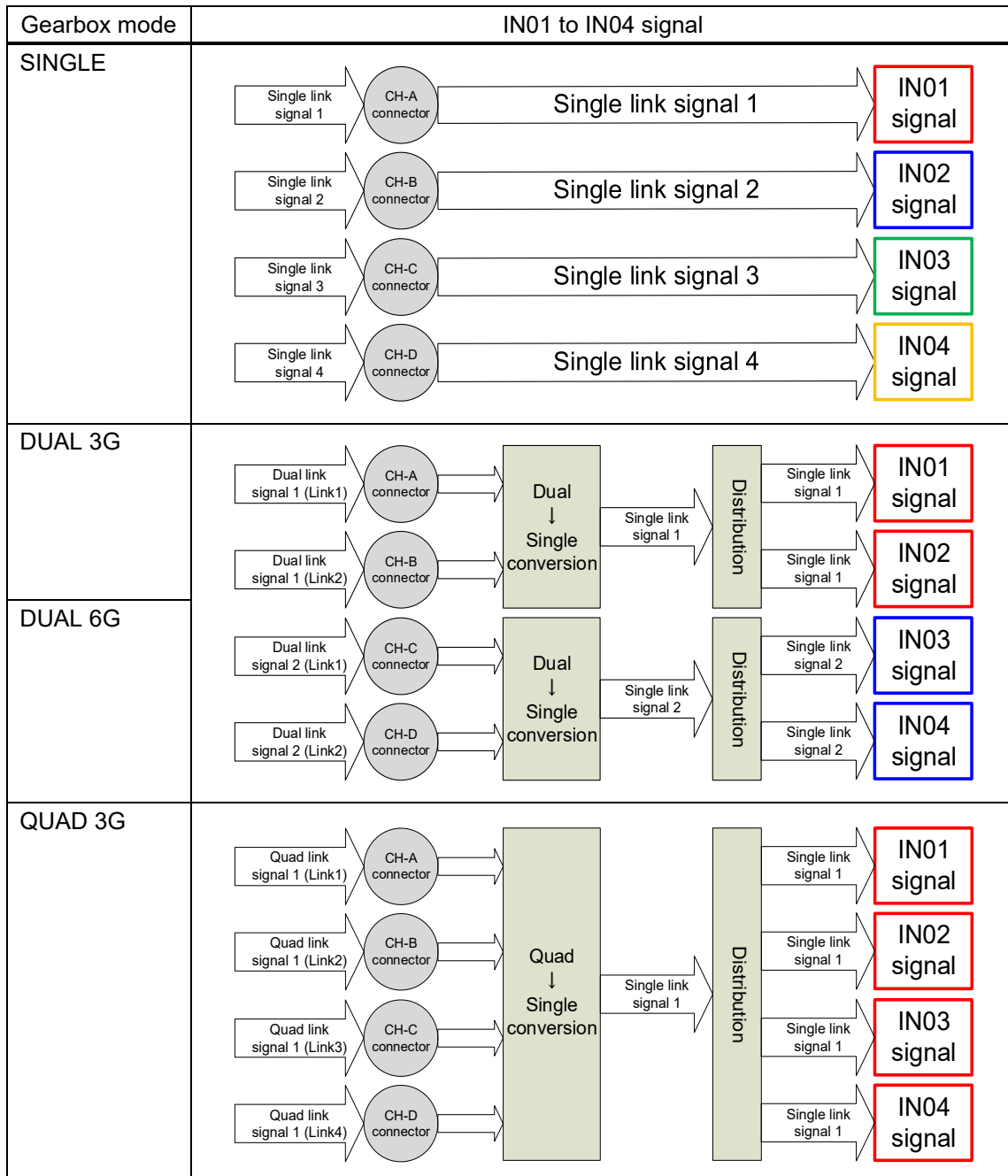

Input can be set for each channel. For example, for SLOT1, if “DUAL 3G” is selected, signals of IN01 and IN02 are the same. However, IN01 and IN02 can be used as input signals having different audio signals if input audio groups are set as follows:

- IN01: Group1 and Group2
- IN02: Group3 and Group4

“FOLLOW PID” reads the payload ID of CH-A input signal and determines automatically the optimal mode for input signals depending on the first byte of payload ID.

**[Table 10.17] Mode determined by payload ID**

Payload ID First byte (Hex)	Determined input signal	Gearbox mode
“94” or “96”	3G dual link signal	DUAL 3G
“C2” or “C3”	6G dual link signal	DUAL 6G
“97”	3G quad link signal	QUAD 3G
Others (Including no signal input)	Single link signal	SINGLE

**Notes:**

- If “SINGLE” is selected, multi link signals cannot be input.
- If multi link settings other than “FOLLOW PID” (“DUAL 3G”, “DUAL 6G”, and “QUAD 3G”) is selected, signals that are not supported cannot be input.  
For example, if “DUAL 6G” is selected, single link signals or 3G dual link signals cannot be input.
- For multi link operation (including multi link operation by “FOLLOW PID”), connect and input signals according to the order of signal link numbers.
- Signal type (Multi link/Single link) and link number of multi link signal can be viewed by checking the input status of the WEB browser.  
However, numbering of 3G dual link signal differs depending on source devices. Check the output specification of the source device and connect in the correct link order.
- For FDX-S64U, SDI input gearbox mode cannot be used and this menu is not displayed. Only “SINGLE” is available.

■ **Input signals that support SDI input**

The following input signals can be input as SDI converted signals.

**[Table 10.18] Input signals supporting SDI input**

[1/2]

Input format					FDX-SIV4S	FDX-SIV4US
Format	Resolution, I/P	Frame rate [Hz]	Color space (Sampling structure)	Bit depth [bit]		
SD-SDI	720×480i	60, 59.94	YCbCr 4:2:2	10	✓	N/A
	720×576i	50	YCbCr 4:2:2	10	✓	N/A
HD-SDI	1280×720p	25	YCbCr 4:2:2	10	✓	✓
		50 60, 59.94				
	1920×1080i	50 60, 59.94	YCbCr 4:2:2	10	✓	✓
3G-SDI Level-A	1280×720p	24, 23.98 25 30, 29.97 50 60, 59.94	YCbCr 4:4:4 RGB	10	✓	✓
		1920×1080i	50 60, 59.94	YCbCr 4:2:2	10	✓
	1920×1080p		24, 23.98 25 30, 29.97	YCbCr 4:4:4 RGB	10, 12	✓
3G-SDI Level-B		1920×1080i	50 60, 59.94	YCbCr 4:2:2	10	✓
	1920×1080p		24, 23.98 25 30, 29.97	YCbCr 4:4:4 RGB	10, 12	✓
		1920×1080p	50 60, 59.94	YCbCr 4:2:2	10	✓

[2/2]

Input format					FDX-SIV4S	FDX-SIV4US
Format	Resolution, I/P	Frame rate [Hz]	Color space (Sampling structure)	Bit depth [bit]		
3G-SDI Level-B (Dual Stream)	1280×720p	24, 23.98 25	YCbCr 4:2:2	10	✓	N/A
		30, 29.97 50 60, 59.94				
	1920×1080i	50 60, 59.94	YCbCr 4:2:2	10	✓	N/A
6G-SDI (SINGLE/ DUAL 3G)	1920×1080p	50	YCbCr 4:2:2	10	N/A	✓
		60, 59.94	YCbCr 4:4:4 RGB	10, 12	N/A	✓
	3840×2160p 4096×2160p	24, 23.98 25 30, 29.97	YCbCr 4:2:2	10	N/A	✓
12G-SDI (SINGLE/ DUAL 6G/ QUAD 3G)	3840×2160p	24, 23.98 25	YCbCr 4:2:0 YCbCr 4:2:2	12	N/A	✓
		30, 29.97	YCbCr 4:4:4 RGB	10, 12	N/A	✓
		50 60, 59.94	YCbCr 4:2:0 YCbCr 4:2:2	10	N/A	✓
	4096×2160p	24, 23.98 25 30, 29.97	YCbCr 4:2:2	12	N/A	✓
	3840×2160p	50 60, 59.94	YCbCr 4:4:4 RGB	10, 12	N/A	✓
	4096×2160p	50 60, 59.94 48, 47.95	YCbCr 4:2:2	10	N/A	✓

Input signals other than signals above are not detected correctly.

## 10.8 Input timing

You can set the timing parameters for inputs.

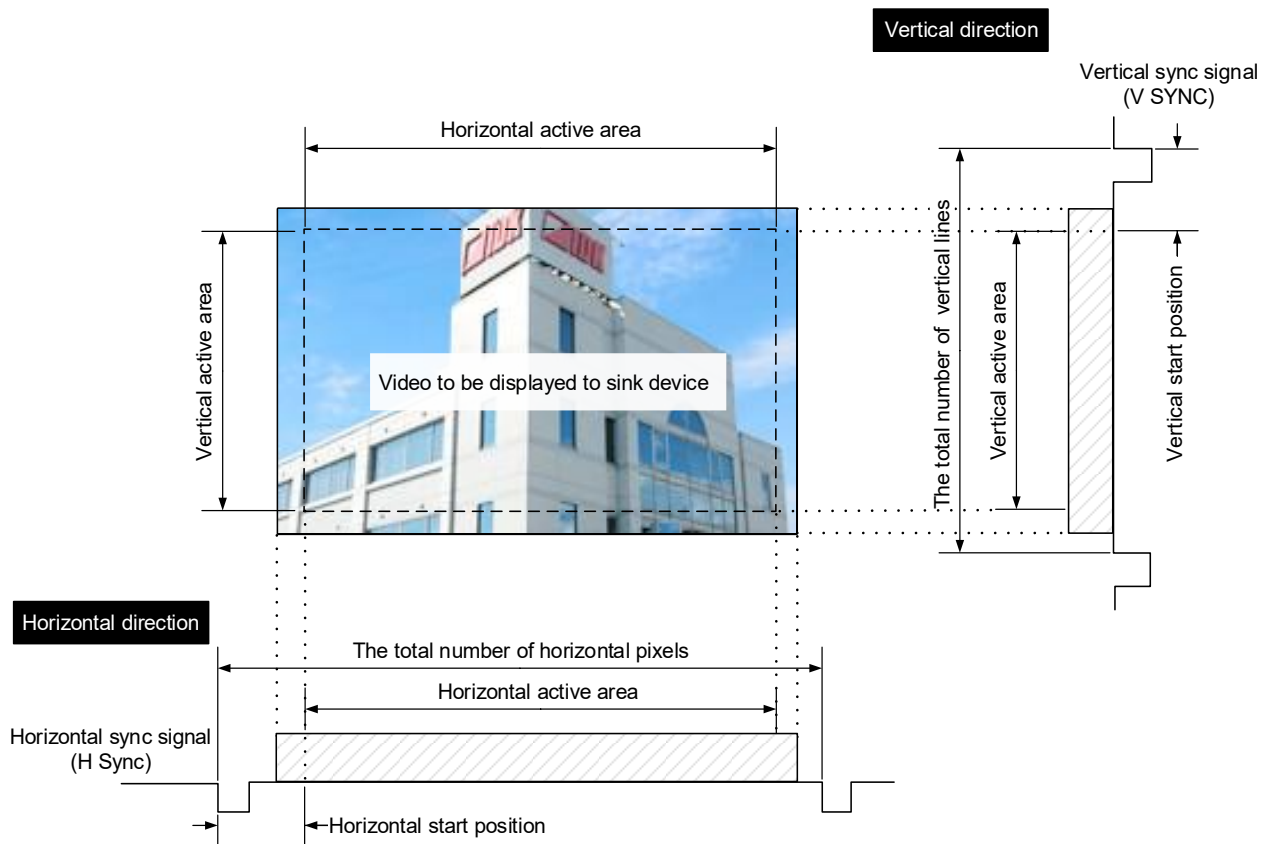

[Fig. 10.21] Input area

### 10.8.1 Horizontal start position

Scan conversion output only

Menu	Top→INPUT TIMING→H START POSITION
Setting for	IN01 to INn for each input signal
Setting value	-100DOT to +100DOT [Default] 0DOT

You can set the horizontal start positions of input video.

## 10.8.2 Horizontal active area

Scan conversion output only

---

Menu	Top→INPUT TIMING→H ACTIVE
Setting for	IN01 to INn for each input signal
Setting value	-100DOT to +100DOT [Default] 0DOT

You can set the horizontal active area of input video.

## 10.8.3 Vertical start position

Scan conversion output only

---

Menu	Top→INPUT TIMING→V START POSITION
Setting for	IN01 to INn for each input signal
Setting value	-30LINE to +30LINE [Default] 0LINE

You can set the vertical start positions of input video.

## 10.8.4 Vertical active area

Scan conversion output only

---

Menu	Top→INPUT TIMING→V ACTIVE
Setting for	IN01 to INn for each input signal
Setting value	-30LINE to +30LINE [Default] 0LINE

You can set the vertical active area of input video.

## 10.9 Picture controls

Setting items for input channels are for correcting color bias.

Image quality to be output can be set for each input channel and output channel as follows:

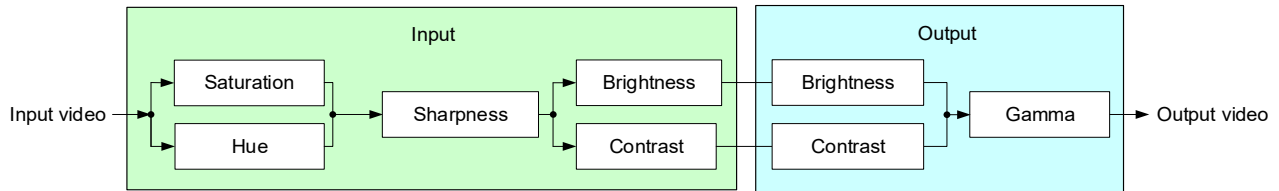

[Fig. 10.22] Picture controls

### 10.9.1 Output brightness

Scan conversion output only

Menu	Top→PICTURE ADJUSTMENT→OUTPUT BRIGHTNESS
Setting for	ALL, OUT01 to OUTn
Setting value	0% to 200% [Default] 100%

You can set the brightness level for each output signal.

### 10.9.2 Output contrast

Scan conversion output only

Menu	Top→PICTURE ADJUSTMENT→OUTPUT CONTRAST
Setting for	ALL, OUT01 to OUTn
Setting value	R/G/B: 0% to 200% [Default] R/G/B: 100%

You can set the contrast for the output video image.

Select "A" to change the settings of "R", "G" and "B" relatively from the current setting values.

### 10.9.3 Output gamma

Scan conversion output only

Menu	Top→PICTURE ADJUSTMENT→OUTPUT GAMMA
Setting for	ALL, OUT01 to OUTn
Setting value	0.1 to 3.0 (by 0.1) [Default] 1.0 NORMAL

You can adjust the gamma curve independently or each output signal.

## 10.9.4 Output video correction initialization

Scan conversion output only

Menu	Top→PICTURE ADJUSTMENT→OUTPUT SETTING INIT.
Setting for	ALL, OUT01 to OUTn
Setting value	OFF [Default], INITIALIZE: Initializes the following settings of output video: 10.9.1 Output brightness 10.9.2 Output contrast 10.9.3 Output gamma

Press the “MENU/ENTER” button to apply the setting, and you will hear a long beep sound.

## 10.9.5 Input sharpness

Scan conversion output only

Menu	Top→PICTURE ADJUSTMENT→INPUT SHARPNESS
Setting for	IN01 to INn for each input signal
Setting value	-5 to +15 [Default] 0 NORMAL

You can set the desired level of sharpness for each input signal.

## 10.9.6 Input brightness

Scan conversion output only

Menu	Top→PICTURE ADJUSTMENT→INPUT BRIGHTNESS
Setting for	IN01 to INn for each input signal
Setting value	0% to 200% [Default] 100%

You can set the brightness level for each input signal.

## 10.9.7 Input contrast

Scan conversion output only

Menu	Top→PICTURE ADJUSTMENT→INPUT CONTRAST
Setting for	IN01 to INn for each input signal
Setting value	R/G/B: 0% to 200% [Default] R/G/B: 100%

You can set the contrast for the input video image.

Select “A” to change the settings of “R”, “G” and “B” relatively from the current setting values.

## 10.9.8 Input hue

Scan conversion output only

Menu	Top→PICTURE ADJUSTMENT→INPUT HUE
Setting for	IN01 to INn for each input signal
Setting value	0° to 359° [Default] 0°

You can set the color HUE for each input signal.

## 10.9.9 Input saturation

Scan conversion output only

Menu	Top→PICTURE ADJUSTMENT→INPUT SATURATION
Setting for	IN01 to INn for each input signal
Setting value	0% to 200% [Default] 100%

You can set the color saturation independently for each input signal.

## 10.9.10 Input video correction initialization

Scan conversion output only

Menu	Top→PICTURE ADJUSTMENT→INPUT SETTING INIT.
Setting for	IN01 to INn for each input signal
Setting value	OFF [Default], INITIALIZE: Initializes the following settings of output video: 10.9.5 Input sharpness 10.9.6 Input brightness 10.9.7 Input contrast 10.9.8 Input hue 10.9.9 Input saturation

Press the "MENU/ENTER" button to apply the setting, and you will hear a long beep sound.

## 10.10 Output audio

### 10.10.1 Mute

Menu Top→OUTPUT AUDIO SETTINGS→MUTE  
 Setting for ALL, OUT01 to OUTn, ANALOG01 to ANALOG12, DANTE01 to DANTE32  
 Setting value OFF [Default], ON

You can mute/unmute the audio of output boards and audio boards.

### 10.10.2 Output Lip Sync

Scan conversion output and analog audio output only

Menu Top→OUTPUT AUDIO SETTINGS→LIP SYNC  
 Setting for ALL, OUT01 to OUTn, ANALOG01 to ANALOG12  
 Setting value 0 mSec to 256 mSec [Default] 0 mSec

You can adjust the time gap between video (motion) and audio (sound).

For the FDX-S64U, up to two audio boards can be installed.

Settable analog audio output channels vary depending on the audio board and slot.

**[Table 10.19] Installed board and settable analog audio output channel (For FDX-S64U)**

		Settable analog audio output channel
OPTION A	FDX-SAB4A	ANALOG-A01 to ANALOG-A04
	FDX-SOA12A	ANALOG-A01 to ANALOG-A12
OPTION B	FDX-SAB4A	ANALOG-B01 to ANALOG-B04
	FDX-SOA12A	ANALOG-B01 to ANALOG-B12

### 10.10.3 Audio embedding

Menu	Top→OUTPUT AUDIO SETTINGS→EMBEDDED
Setting for	ALL, OUT01 to OUTn
Setting value	DIGITAL [Default], ANALOG01 to ANALOG04, DANTE01 to DANTE32

You can set the audio that is output from the output board.

**[Table 10.20] Audio embedding**

Setting value	Description
DIGITAL	Digital audio of selected video input channel is output.
ANALOG01 to 04	Analog input audio is output. Only if FDX-SAB4A is installed.
DANTE01 to 32	Dante input audio is output. Only if FDX-SAB64D is installed.

For the FDX-S64U, up to two audio boards can be installed.

Settable input channels of analog audio and Dante vary depending on the audio board and slot.

**[Table 10.21] Installed board and settable audio input channel (For FDX-S64U)**

		Settable audio input channel
OPTION A	FDX-SAB4A	ANALOG-A01 to ANALOG-A04
	FDX-SAB64D	DANTE-A01 to DANTE-A32
OPTION B	FDX-SAB4A	ANALOG-B01 to ANALOG-B04
	FDX-SAB64D	DANTE-B01 to DANTE-B32

If “Digital” is selected, a 4K@60 scan conversion multiview output board outputs audio of video signal that is set for the window selected in “**10.10.5 Audio setting**”.

## 10.10.4 Audio de-embedding

Menu	Top→OUTPUT AUDIO SETTINGS→DE-EMBEDDED
Setting for	ALL, ANALOG01 to ANALOG12, DANTE01 to DANTE32
Setting value	IN01 to INn, OUT01 to OUTn

You can set the audio that is output from the audio board.

**[Table 10.22] Audio de-embedding**

Setting value	Description
IN01 to IN n	Digital audio of video input channel is output.
OUT01 to OUTn	Digital audio of video input channel that is selected for video output channel is output. If video input channel setting is changed by changing crosspoint, along with the changing, the output audio is also changed.

Settable audio output channel and default values vary depending on the audio board.

Default values are as follows.

IN01 to INn: Straight connection (If the video input board is not installed, the analog or DANTE audio channel is assigned to IN01.)

**[Table 10.23] Installed board and settable audio output channel**

Installed board	Settable audio output channel	Default
FDX-SAB4A	ANALOG01 to ANALOG04	IN01 to IN04 Straight connection
FDX-SOA12A	ANALOG01 to ANALOG12	IN01 to IN12 Straight connection
FDX-SAB64D	DANTE01 to DANTE32	IN01 to IN32 Straight connection

For the FDX-S64U, up to two audio boards can be installed.

Settable input channels of analog audio and Dante vary depending on the audio board and slot. The default values also depend on the slot.

**[Table 10.24] Installed board and settable audio output channel (For FDX-S64U)**

		Settable audio output channel	Default
OPTION A	FDX-SAB4A	ANALOG-A01 to ANALOG-A04	IN01 to IN04 Straight connection
	FDX-SOA12A	ANALOG-A01 to ANALOG-A12	IN01 to IN12 Straight connection
	FDX-SAB64D	DANTE-A01 to DANTE-A32	IN01 to IN32 Straight connection
OPTION B	FDX-SAB4A	ANALOG-B01 to ANALOG-B04	IN33 to IN36 Straight connection
	FDX-SOA12A	ANALOG-B01 to ANALOG-B12	IN33 to IN44 Straight connection
	FDX-SAB64D	DANTE-B01 to DANTE-B32	IN33 to IN64 Straight connection

**Note:**

If video input channel audio is multi-channel LPCM signal, it is down mixed.

If video input channel audio is compressed audio, it is not output (muted).

The output number (OUT01 to OUTn) of a 4K@60 scan conversion multiview output board outputs the digital audio of video input channel selected for window A to D.

【See: 10.17 Multi window output】

## 10.10.5 Audio setting

Scan conversion multiview output only

Menu	Top→OUTPUT AUDIO SETTINGS→AUDIO OUT SELECT
Setting for	ALL, OUT01 to OUTn
Setting value	WINDOW A [Default], WINDOW B, WINDOW C, WINDOW D

You can set the audio to be output from a 4K@60 scan conversion multiview output board.  
This setting is enabled if “DIGITAL” is selected in “10.10.3 Audio embedding”.

## 10.10.6 SDI output audio group

12G-SDI output only

Menu	Top→OUTPUT AUDIO SETTINGS→SDI AUDIO GROUP
Setting for	OUT01 to OUTn
Setting value	

**[Table 10.25] SDI output audio group**

Primary/Secondary	Setting value	Default
PRI (Primary)	1: Audio group (CH1 to CH4) 2: Audio group (CH5 to CH8)	1
SEC (Secondary)	3: Audio group (CH9 to CH12) 4: Audio group (CH13 to CH16)	2

You can set the SDI output audio group that be assigned to eight multi-channel output audio.  
Up to 16 audio channels are in SDI output audio, and these channels are divided into one to four groups by four channels.

Press the “MENU/ENTER” button to apply the setting.

**Notes:**

- The same audio group cannot be set for “PRI” and “SEC”.
- Audio of sampling frequencies (other than 48 kHz) cannot be output.
- Standard SDI multi-channel audio is specified by SMPTE 320M; assignment of CH3 and CH4 for SDI and HDMI are opposite. CH3 and CH4 of PRI (HDMI audio CH1 to CH4) are the swapped SDI signals.
- For HDMI output of SDI input board signals and for SDI output of HDMI/DVI/HDBaseT input board signals, CH3 and CH4 are swapped. For SDI output of SDI input board signals, no channel is swapped. (If default values of SDI input audio group/SDI output audio group are selected)  
Up to eight audio channels can be transmitted.

【See: 10.11.2 SDI input audio group】

## 10.11 Input audio

### 10.11.1 Stable audio input wait

Boards other than SDI

Menu	Top→INPUT AUDIO SETTINGS→STABLE WAIT
Setting for	ALL, IN01 to INn
Setting value	OFF, SHORT, MID [Default], LONG

This feature is for waiting until input audio becomes stable in order to avoid popping noise when audio source is turned on or the like.

If initial sound cannot be output, disable this feature. In such a case, however, noise may be caused at the start.

### 10.11.2 SDI input audio group

SDI input only

Menu	Top→INPUT SETTINGS→SDI AUDIO GROUP
Setting for	IN01 to INn
Setting value	

[Table 10.26] SDI input audio group

Primary/Secondary	Setting value	Default
PRI (Primary)	1: Audio group (CH1 to CH4) 2: Audio group (CH5 to CH8)	1
SEC (Secondary)	3: Audio group (CH9 to CH12) 4: Audio group (CH13 to CH16)	2

Up to 16 audio channels are in SDI input audio, and these channels are divided into one to four groups by four channels. Two selected audio groups (primary and secondary) can be output as multi-channel audio. This function sets the SDI input audio group of PRI (CH1 to 4) and SEC (CH5 to 8) that be assigned to eight multi-channel output audio.

Press the “MENU/ENTER” button to apply the setting.

#### Notes:

- The same audio group cannot be set for “PRI” and “SEC”.
- Standard SDI multi-channel audio is specified by SMPTE 320M; assignment of CH3 and CH4 for SDI and HDMI are opposite. Audio groups, CH3 and CH4 that is swapped to PRI are the swapped HDMI signals.
- Up to eight audio channels can be transmitted.

## 10.12 EDID

Boards other than SDI

EDID can be set using the following data:

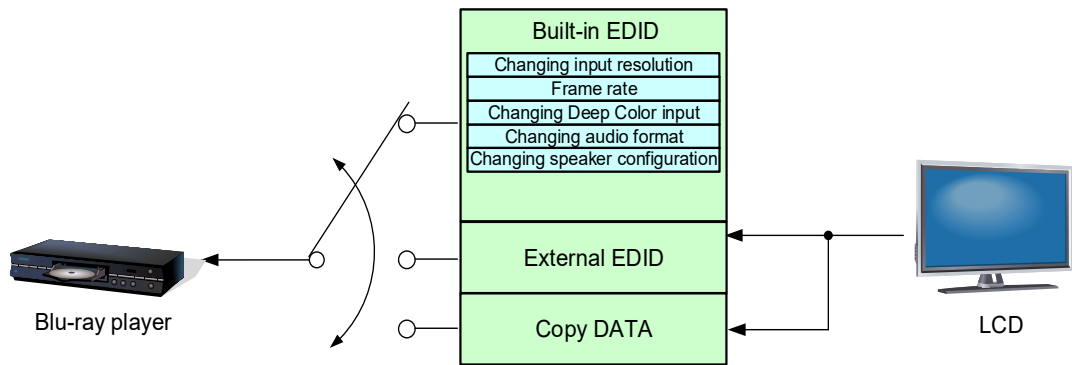

[Fig. 10.23] Setting EDID

## 10.12.1 Resolution

Boards other than SDI

Menu	Top→EDID SETTINGS→RESOLUTION
Setting for	IN01 to INn
Setting value	[Table 10.27] Maximum resolution of EDID

You can set the video resolution that is output from the source device.

This setting will also be applied for controlling output resolution when AV devices (such as Blu-ray players) are connected over HDMI.

Press the “MENU/ENTER” button to apply the setting.

“05 to 45” are the built-in EDID of the FDX-S. If using the internal EDID, specify the maximum supported resolution.

Timing of 720p, 1080i, 1080p, 2160p, and 4096x2160 is the same as that of HD signal meeting the CTA-861 standard.

For other resolutions, timing parameters meet the VESA DMT or VESA CVT standards.

HDR is supported if external EDID is selected for EDID setting while an HDR-supported sink device is connected or if copied EDID of an HDR-supported sink device is selected for EDID setting.

3D is supported if external EDID is selected for EDID setting while a 3D-supported sink device is connected or if copied EDID of 3D-supported sink device is selected for EDID setting.

**[Table 10.27] Maximum resolution of EDID**

[1/2]

Setting value	Maximum resolution	Pixels	Standard	Remarks
00	EXTERNAL (External EDID)	—	—	If no acquired data, the default EDID will be applied.
01	Copied EDID1	—	—	
02	Copied EDID2	—	—	
03	Copied EDID3	—	—	
04	Copied EDID4	—	—	
05	1080p	1920×1080	HDTV	
06	720p	1280×720		
07	1080i	1920×1080		
08	SVGA	800×600	VESA	
09	XGA	1024×768		
10	VESA720	1280×720	CVT	For DVI device input
11	WXGA	1280×768	VESA	
12	WXGA	1280×800		MAC supported
13	Quad-VGA	1280×960		
14	SXGA	1280×1024		
15	WXGA	1360×768		

Setting value	Maximum resolution	Pixels	Standard	Remarks
16	WXGA	1366×768		
17	SXGA+	1400×1050		
18	WXGA+	1440×900		
19	WXGA++	1600×900		
20	UXGA	1600×1200	VESA	
21	WSXGA+	1680×1050		
22	VESA1080	1920×1080	CVT	For DVI device input
23	WUXGA	1920×1200	VESA	
24	QWXGA	2048×1152		
25	WQHD	2560×1440		
26	WQXGA	2560×1600		
40	2160p (24/25/30)	3840×2160	UHDTV	
41	2160p (50/59.94/60, 4:2:0)	3840×2160	UHDTV	[Default] (FDX-SIV4UH (FDX-S64U), FDX-SIV4UT) YCbCr4:2:0 supported
42 <sup>*1</sup>	2160p (50/59.94/60, 4:4:4)	3840×2160	UHDTV	[Default] (FDX-SIV4UH (Other than FDX-S64U)) YCbCr4:2:0, YCbCr4:2:2, YCbCr4:4:4 supported
43	4096×2160 (24/25/30)	4096×2160	DCI	
44	4096×2160 (50/59.94/60, 4:2:0)	4096×2160	DCI	YCbCr4:2:0 supported
45 <sup>*1</sup>	4096×2160 (50/59.94/60, 4:4:4)	4096×2160	DCI	YCbCr4:2:0, YCbCr4:2:2, YCbCr4:4:4 supported

<sup>\*1</sup> HDBaseT input board (FDX-SIV4UT) and FDX-S64U are not supported.

**Notes:**

- For 4096x2160 (“43”, “44”, “45”)
 

The source device may select 3840x2160 (30p, YCbCr 4:4:4) depending on the EDID definition. First set built-in EDID and then select 4096x2160 in the source device side.
- For YCbCr4:2:0 (“41”, “44”)
 

The source device may select 3840x2160 (30p, YCbCr 4:4:4) depending on the EDID definition. First set built-in EDID and then select YCbCr 4:2:0 in the source device side.
- If a source device that does not support 4K is connected to an input connector having 4K EDID, the source device may output DVI signal meaning audio is not output. To output HDMI signal, change the EDID setting to a format other than 4K.

【See: 10.12.2 Copying EDID】

【See: 10.12.3 External EDID】

[Table 10.28] Supported resolution

Input resolution setting	Supported resolution	Supported resolution																									
		640×480	800×600	1024×768	1280×720	1280×768	1280×800	1280×960	1280×1024	1360×768	1366×768	1400×1050	1440×900	1600×900	1600×1200	1680×1050	1920×1080	1920×1200	2048×1152	2560×1440	2560×1600	3840×2160(30p)	4096×2160(30p)	3840×2160(60p)	4096×2160(60p)		
00	—	—	—	—	—	—	—	—	—	—	—	—	—	—	—	—	—	—	—	—	—	—	—	—	—	—	
01	—	—	—	—	—	—	—	—	—	—	—	—	—	—	—	—	—	—	—	—	—	—	—	—	—	—	
02	—	—	—	—	—	—	—	—	—	—	—	—	—	—	—	—	—	—	—	—	—	—	—	—	—	—	
03	—	—	—	—	—	—	—	—	—	—	—	—	—	—	—	—	—	—	—	—	—	—	—	—	—	—	
04	—	—	—	—	—	—	—	—	—	—	—	—	—	—	—	—	—	—	—	—	—	—	—	—	—	—	
05	1080p	Y	Y	Y	N	N	Y	Y	Y	Y	Y	Y	Y	Y	Y	Y	Y	N	N	N	N	N	N	N	N	N	
06	720p	Y	Y	N	Y	N	N	N	N	N	N	N	N	N	N	N	N	N	N	N	N	N	N	N	N	N	
07	1080i	Y	Y	Y	N	N	N	N	N	N	N	N	N	N	N	N	N	N	N	N	N	N	N	N	N	N	
08	800×600	Y	Y	N	N	N	N	N	N	N	N	N	N	N	N	N	N	N	N	N	N	N	N	N	N	N	
09	1024×768	Y	Y	Y	N	N	N	N	N	N	N	N	N	N	N	N	N	N	N	N	N	N	N	N	N	N	
10	1280×720	Y	Y	Y	Y	N	N	N	N	N	N	N	N	N	N	N	N	N	N	N	N	N	N	N	N	N	
11	1280×768	Y	Y	Y	Y	Y	N	N	N	N	N	N	N	N	N	N	N	N	N	N	N	N	N	N	N	N	
12	1280×800	Y	Y	Y	Y	Y	Y	N	N	N	N	N	N	N	N	N	N	N	N	N	N	N	N	N	N	N	
13	1280×960	Y	Y	Y	Y	Y	Y	Y	N	N	N	N	N	N	N	N	N	N	N	N	N	N	N	N	N	N	
14	1280×1024	Y	Y	Y	Y	Y	Y	Y	Y	N	N	N	N	N	N	N	N	N	N	N	N	N	N	N	N	N	
15	1360×768	Y	Y	Y	Y	Y	Y	Y	Y	Y	Y	N	N	N	N	N	N	N	N	N	N	N	N	N	N	N	
16	1366×768	Y	Y	Y	Y	Y	Y	Y	Y	Y	Y	N	N	N	N	N	N	N	N	N	N	N	N	N	N	N	
17	1400×1050	Y	Y	Y	Y	N	Y	Y	Y	Y	Y	Y	N	N	N	N	N	N	N	N	N	N	N	N	N	N	
18	1440×900	Y	Y	Y	Y	N	Y	Y	Y	Y	Y	Y	N	N	N	N	N	N	N	N	N	N	N	N	N	N	
19	1600×900	Y	Y	Y	Y	N	Y	Y	Y	Y	Y	Y	Y	N	N	N	N	N	N	N	N	N	N	N	N	N	
20	1600×1200	Y	Y	Y	Y	N	Y	Y	Y	Y	Y	Y	Y	Y	N	N	N	N	N	N	N	N	N	N	N	N	
21	1680×1050	Y	Y	Y	Y	N	Y	Y	Y	Y	Y	Y	Y	Y	Y	N	N	N	N	N	N	N	N	N	N	N	
22	1920×1080	Y	Y	Y	N	N	Y	Y	Y	Y	Y	Y	Y	Y	Y	Y	Y	N	N	N	N	N	N	N	N	N	
23	1920×1200	Y	Y	Y	N	N	Y	Y	Y	N	N	Y	Y	Y	Y	Y	Y	Y	N	N	N	N	N	N	N	N	
24	2048×1152	Y	Y	Y	N	N	N	Y	Y	N	N	Y	Y	Y	Y	Y	Y	Y	Y	N	N	N	N	N	N	N	
25	2560×1440	Y	Y	Y	N	N	N	N	Y	N	N	Y	Y	Y	Y	Y	Y	Y	Y	Y	Y	N	N	N	N	N	
26	2560×1600	Y	Y	Y	N	N	N	N	Y	N	N	Y	Y	Y	Y	Y	Y	Y	Y	Y	Y	Y	N	N	N	N	
40	2160p (24/25/30)	Y	Y	Y	N	N	N	N	Y	N	N	Y	Y	Y	Y	Y	Y	Y	Y	Y	Y	Y	Y	N	N	N	
41	2160p (50/59.94/60, 4:2:0)	Y	Y	Y	N	N	N	N	Y	N	N	Y	Y	Y	Y	Y	Y	Y	Y	Y	Y	Y	Y	Y	N	P	N
42	2160p (50/59.94/60, 4:4:4)	Y	Y	Y	N	N	N	N	Y	N	N	Y	Y	Y	Y	Y	Y	Y	Y	Y	Y	Y	Y	Y	N	Y	N
43	4096×2160 (24/25/30)	Y	Y	Y	N	N	N	N	Y	N	N	Y	Y	Y	Y	Y	Y	Y	Y	Y	Y	Y	Y	Y	Y	N	N
44	4096×2160 (50/59.94/60, 4:2:0)	Y	Y	Y	N	N	N	N	Y	N	N	Y	Y	Y	Y	Y	Y	Y	Y	Y	Y	Y	Y	Y	Y	P	P
45	4096×2160 (50/59.94/60, 4:4:4)	Y	Y	Y	N	N	N	N	Y	N	N	Y	Y	Y	Y	Y	Y	Y	Y	Y	Y	Y	Y	Y	Y	Y	Y

Y: Supported, P: Only YCbCr 4:2:0, N: Not supported, —: Not used

## 10.12.2 Copying EDID

Boards other than SDI

Menu	Top→EDID SETTINGS→SINK DEVICE EDID COPY
Setting for	Each copied EDID stored area (1[xxx] to 4[xxx])
Setting value	OUT01[xxx]* to OUTn[xxx]*: EDID data if sink device that is connected to output connector * "xxx": Manufacturer ID of the saved EDID

EDID of sink device is loaded and registered to the FDX-S. SDI output cannot be selected.

The EDID's manufacture ID [xxx] is displayed as the copied EDID name.

Press the "MENU/ENTER" button to apply the setting.

### Note:

If no acquired data for copied EDID, the default EDID will be applied.

## 10.12.3 External EDID

Boards other than SDI

Menu	Top→EDID SETTINGS→CH. FOR EXTERNAL MODE
Setting for	ALL, IN01 to INn
Setting value	OUT1 to OUTn [Default] OUT1

You can set the output connector to be recalled when the EDID type is set to "EXTERNAL". SDI output cannot be selected.

Press the "MENU/ENTER" button to apply the setting.

【See: 10.12.1 Resolution】

## 10.12.4 HDMI/DVI

Boards other than SDI

Menu	Top→EDID SETTINGS→SIGNAL FORMAT
Setting for	ALL, IN01 to INn
Setting value	HDMI [Default], DVI

You can select EDID signal format.

This setting will be valid only if one of "05 to 26", "40" or "43" is selected for EDID in "10.12.1 Resolution".

Press the "MENU/ENTER" button to apply the setting.

### 10.12.5 Frame rate

Boards other than SDI

Menu	Top→EDID SETTINGS→FRAME RATE
Setting for	ALL, IN01 to INn
Setting value	60Hz [Default], 50Hz

You can set the video frequency that is output from source device.

This setting will be valid only if one of “05” to “45” is selected for EDID in “**10.12.1 Resolution**”.

Press the “MENU/ENTER” button to apply the setting.

If “**10.12.1 Resolution**” is set to “40” or “43”, the frequency will be 25 Hz (if 50 Hz is selected) or 30 Hz (if 60 Hz is selected).

### 10.12.6 Deep Color

Boards other than SDI

Menu	Top→EDID SETTINGS→DEEP COLOR
Setting for	ALL, IN01 to INn
Setting value	24Bit [Default], 30Bit, 36Bit

You can set the color depth to be output from the source device.

This setting will be valid only if one of “05 to 45” is selected for EDID in “**10.12.1 Resolution**” and “HDMI” is selected for “**10.12.4 HDMI/DVI**”.

If you select “30Bit” and “36Bit”, compared to “24Bit”, “30Bit” and “36Bit” are transmitted using a higher clock frequency. The clock frequency may cause noise if a poor-quality or an excessively long cable is connected. In such a case, the noise may be removed by setting the color to “24Bit”.

Press the “MENU/ENTER” button to apply the setting.

**Note:**

For 4K@50/59.94/60 (YCbCr 4:4:4), “24 bit/pixel (8 bit/component)” is selected automatically.

### 10.12.7 LPCM audio

Boards other than SDI

Menu	Top→EDID SETTINGS→Linear PCM
Setting for	ALL, IN01 to INn
Setting value	<ul style="list-style-type: none"> <li>• 32kHz    • 44.1kHz    • 48kHz [Default]    • 88.2kHz</li> <li>• 96 kHz    • 176.4kHz    • 192kHz</li> </ul>

You can set the Maximum LPCM sampling frequency that is output from the source device.

This setting will be valid only if one of “05 to 45” is selected for EDID in “**10.12.1 Resolution**” and “HDMI” is selected for “**10.12.4 HDMI/DVI**”.

Press the “MENU/ENTER” button to apply the setting.

## 10.12.8 AAC audio

Boards other than SDI

Menu	Top→EDID SETTINGS→AAC			
Setting for	ALL, IN01 to INn			
Setting value	<ul style="list-style-type: none"> <li>• OFF [Default]    • 96kHz        • 88.2kHz        • 48kHz</li> <li>• 44.1kHz         • 32kHz</li> </ul>			

You can set the maximum AAC audio sampling frequency that is output from the source device. This setting will be valid only if one of “05 to 45” is selected for EDID in “**10.12.1 Resolution**” and “HDMI” is selected for “**10.12.4 HDMI/DVI**”.

Press the “MENU/ENTER” button to apply the setting.

## 10.12.9 Dolby Digital audio

Boards other than SDI

Menu	Top→EDID SETTINGS→Dolby Digital			
Setting for	ALL, IN01 to INn			
Setting value	<ul style="list-style-type: none"> <li>• OFF [Default]    • 48kHz        • 44.1kHz        • 32kHz</li> </ul>			

You can set the maximum Dolby Digital audio sampling frequency that is output from the source device. This setting will be valid only if one of “05 to 45” is selected for EDID in “**10.12.1 Resolution**” and “HDMI” is selected for “**10.12.4 HDMI/DVI**”.

Press the “MENU/ENTER” button to apply the setting.

## 10.12.10 Dolby Digital Plus audio

Boards other than SDI

Menu	Top→EDID SETTINGS→Dolby Digital Plus			
Setting for	ALL, IN01 to INn			
Setting value	<ul style="list-style-type: none"> <li>• OFF [Default]    • 48kHz        • 44.1kHz        • 32kHz</li> </ul>			

You can set the maximum Dolby Digital Plus audio sampling frequency that is output from the source device. This setting will be valid only if one of “05 to 45” is selected for EDID in “**10.12.1 Resolution**” and “HDMI” is selected for “**10.12.4 HDMI/DVI**”.

Press the “MENU/ENTER” button to apply the setting.

### 10.12.11 Dolby TrueHD audio

Boards other than SDI

Menu	Top→EDID SETTINGS→Dolby TrueHD			
Setting for	ALL, IN01 to INn			
Setting value	<ul style="list-style-type: none"> <li>• OFF [Default]    • 192kHz    • 176.4kHz    • 96kHz</li> <li>• 88.2kHz        • 48kHz       • 44.1kHz</li> </ul>			

You can set the maximum Dolby TrueHD audio sampling frequency that is output from the source device. This setting will be valid only if one of “05 to 45” is selected for EDID in “**10.12.1 Resolution**” and “HDMI” is selected for “**10.12.4 HDMI/DVI**”.

Press the “MENU/ENTER” button to apply the setting.

### 10.12.12 DTS audio

Boards other than SDI

Menu	Top→EDID SETTINGS→DTS				
Setting for	ALL, IN01 to INn				
Setting value	<ul style="list-style-type: none"> <li>• OFF [Default]    • 96kHz       • 48kHz       • 44.1kHz       • 32kHz</li> </ul>				

You can set the maximum DTS audio sampling frequency that is output from the source device. This setting will be valid only if one of “05 to 45” is selected for EDID in “**10.12.1 Resolution**” and “HDMI” is selected for “**10.12.4 HDMI/DVI**”.

Press the “MENU/ENTER” button to apply the setting.

### 10.12.13 DTS-HD audio

Boards other than SDI

Menu	Top→EDID SETTINGS→DTS-HD			
Setting for	ALL, IN01 to INn			
Setting value	<ul style="list-style-type: none"> <li>• OFF [Default]    • 192kHz    • 176.4kHz    • 96kHz</li> <li>• 88.2kHz        • 48kHz       • 44.1kHz</li> </ul>			

You can set the maximum DTS-HD audio sampling frequency that is output from the source device. This setting will be valid only if one of “05 to 45” is selected for EDID in “**10.12.1 Resolution**” and “HDMI” is selected for “**10.12.4 HDMI/DVI**”.

Press the “MENU/ENTER” button to apply the setting.

### 10.12.14 Speaker configuration

Boards other than SDI

**Menu** Top→EDID SETTINGS→SPEAKER CONFIGURATION  
**Setting for** ALL, IN01 to INn  
**Setting value**

- 2CH : LR [Default]
- 2.1CH: 2.1 channel surround sound
- 5.1CH: 5.1 channel surround sound
- 7.1CH: 7.1 channel surround sound

You can set the speaker configuration for multi-channel audio.

This setting will be valid only if one of “05 to 45” is selected for EDID in “10.12.1 Resolution” and “HDMI” is selected for “10.12.4 HDMI/DVI”.

Press the “MENU/ENTER” button to apply the setting.

**[Table 10.29] Default speaker configuration**

Number of speakers	FL/FR	LFE	FC	RL/RR	RLC/RRC
2 [Default]	ON	OFF	OFF	OFF	OFF
2.1	ON	ON	OFF	OFF	OFF
5.1	ON	ON	ON	ON	OFF
7.1	ON	ON	ON	ON	ON

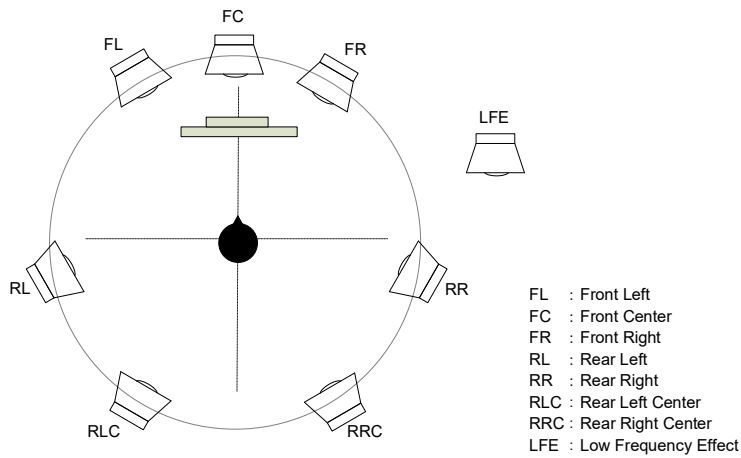

**[Fig. 10.24] Speaker configuration**

## 10.13 RS-232C

---

### 10.13.1 RS-232C communication

---

Menu  Top→RS-232C SETTINGS→PARAMETERS

Setting value

**[Table 10.30] RS-232C communication**

Parameter	Setting value	Default
Baud rate [bps]	4800, 9600, 14400, 19200, 38400	9600
Data bit length [bit]	8, 7	8
Parity check	NONE, EVEN, ODD	NONE
Stop bit [bit]	1, 2	1

You can set the RS-232C communication.

Press the “MENU/ENTER” button to apply the setting.

## 10.14 LAN

---

### **Note:**

HDBaseT/SDVoE LAN communication is established only if the FDX-S is powered on.

### 10.14.1 IP address

---

Menu  Top→LAN SETTINGS→IP ADDRESS

Setting value  192.168.1.199 [Default]

You can set the IP address.

Press the “MENU/ENTER” button to apply the setting.

### 10.14.2 Subnet mask

---

Menu  Top→LAN SETTINGS→SUBNET MASK

Setting value  255.255.255.0 [Default]

You can set the subnet mask.

Press the “MENU/ENTER” button to apply the setting.

### 10.14.3 Gateway address

---

Menu  Top→LAN SETTINGS→GATEWAY ADDRESS  
 Setting value  0.0.0.0 [Default]

You can set the Gateway address.  
 Press the “MENU/ENTER” button to apply the setting.

### 10.14.4 MAC address

---

Menu  Top→LAN SETTINGS→MAC ADDRESS

You can display the FDX-S's MAC address.

### 10.14.5 TCP port number

---

Menu  Top→LAN SETTINGS→PORT NUMBER  
 Setting value  1100 [Default], 6000 to 6999

You can set the TCP port.  
 Press the “MENU/ENTER” button to apply the setting.

### 10.14.6 Output LAN of extension connector

HDBaseT output and SDVoE output only

---

Menu  Top→LAN SETTINGS→OUTPUT LAN THROUGH  
 Setting for  ALL, OUT1 to OUTn  
 Setting value  ON, OFF [Default]

You can enable/disable the LAN capabilities of each HDBaseT/SDVoE output connector.

### 10.14.7 Input LAN of extension connector

HDBaseT input and SDVoE input only

---

Menu  Top→LAN SETTINGS→INPUT LAN THROUGH  
 Setting for  ALL, IN1 to INn  
 Setting value  ON, OFF [Default]

You can enable/disable the LAN capabilities of each HDBaseT/SDVoE input connector.

### 10.14.8 Sending SDVoE device detection packet (Output)

SDVoE output only

---

Menu	Top→LAN SETTINGS→OUTPUT SDVoE DETECTION
Setting for	ALL, OUT01 to OUTn
Setting value	ON : Sends device detection packet [Default] OFF : Does not send device detection packet.

The FDX-S automatically sends device detection packet to LAN periodically.  
To not send unnecessary packet to LAN, set to "OFF".  
If set to "OFF", the IP-NINJAR Configurator cannot detect the FDX-S.

### 10.14.9 Sending SDVoE device detection packet (Input)

SDVoE input only

---

Menu	Top→LAN SETTINGS→INPUT SDVoE DETECTION
Setting for	ALL, IN01 to INn
Setting value	ON : Sends device detection packet [Default] OFF : Does not send device detection packet.

The FDX-S automatically sends device detection packet to LAN periodically.  
To not send unnecessary packet to LAN, set to "OFF".  
If set to "OFF", the IP-NINJAR Configurator cannot detect the FDX-S.

### 10.14.10 Automatic disconnection time (Timeout)

---

Menu	Top→LAN SETTINGS→AUTO DISCONNECT
Setting value	NOT DISCONNECT, 1 Sec to 180 Sec [Default]: 30 Sec

Up to eight connections from an external device to the FDX-S can be set.  
The FDX-S disconnects the LAN communication if the FDX-S does not receive a command for the specified time.

If selecting [NOT DISCONNECT], the FDX-S does not disconnect the communication from its side.  
Communication may not be disabled if exceeding the connection limit.

## 10.15 Preset memory

---

The FDX-S includes up to 32 crosspoint memories and 32 preset memories, and default values are set in each memory. While the former can save and load video I/O channel settings (crosspoint), the latter can save and load other settings, such as picture control settings and the like, in addition to the crosspoint settings.

### 10.15.1 Recalling crosspoint

---

Menu  Top→USER PRESET→RECALL CROSSPOINT  
 Setting for  01 to 32

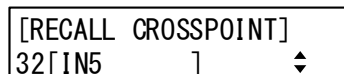

**[Fig. 10.25] Front display (Sample)**

You can recall the I/O channel settings.  
 Press the “MENU/ENTER” button to apply the setting.

**【See: 10.15.2 Saving crosspoint】**

### 10.15.2 Saving crosspoint

---

Menu  Top→USER PRESET→STORE CROSSPOINT  
 Setting for  01 to 32



**[Fig. 10.26] Front display (Sample)**

You can save the I/O channel settings of video into the crosspoint memory.  
 Up to 32 crosspoint memories can be saved with their name (up to 10 characters).  
 You can skip the naming procedure. If you set “---” (not control) for Editing crosspoint, a writing method (CONTINUE (C) or DELETE (D)) can be selected.  
 Press the “MENU/ENTER” button to apply the setting.

**【See: 10.15.3 Editing crosspoint】**

■ **For writing**

“C” : The setting (“---”) will be kept in the crosspoint.

“D” : The current input channel settings will be overwritten.

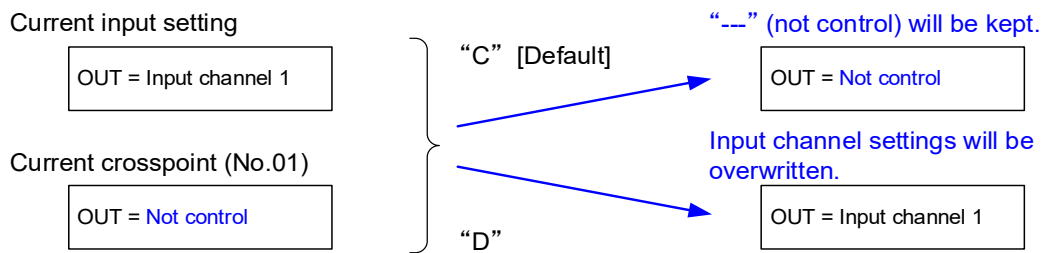

[Fig. 10.27] Saving crosspoint

### 10.15.3 Editing crosspoint

Menu	Top→USER PRESET→EDIT CROSSPOINT
Setting for	01 to 32
Setting value	

[Table 10.31] Editing crosspoint

Setting item	Setting value	Default
Output channel (OUT)	OUT01 to OUTn	OUT01
Input channel	--- (not control), 1 to n, OFF	---
Memory name (NAME)	20 to 7D of ASCII code	20 (space)

You can edit crosspoint settings.

Select the memory number, and then edit the desired setting.

Press the “MENU/ENTER” button to apply the setting.

■ **Not controlling channel**

If you select “---” when setting input channel, channels are not controlled.

Outputs that are set not to be controlled are not switched when crosspoint is loaded.

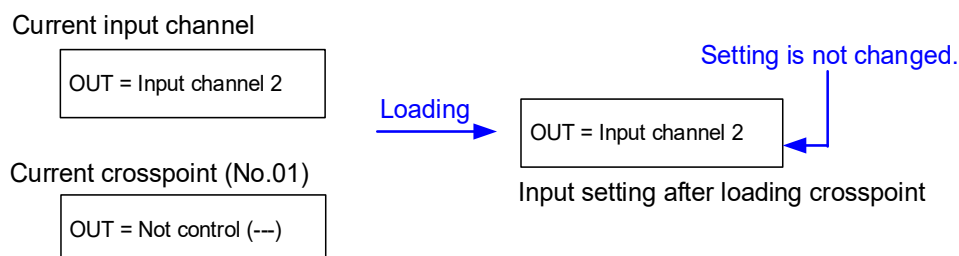

[Fig. 10.28] Loading edited crosspoint

### 10.15.4 Recalling preset memory

Menu Top→USER PRESET→RECALL PRESET SETTINGS  
 Setting for 01 to 32

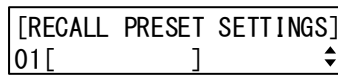

[Fig. 10.29] Front display (Sample)

You can recall settings that are saved in the preset memories.  
 Press the “MENU/ENTER” button to apply the setting.

【See: 10.15.5 Saving preset memory】

### 10.15.5 Saving preset memory

Menu Top→USER PRESET→STORE PRESET SETTINGS  
 Setting for 01 to 32  
 Setting value

You can save up to 32 preset memories and name these memories up to 10 characters from ASCII 20 to 7D.  
 You can skip the naming procedure.  
 Press the “MENU/ENTER” button to apply the setting.

[Table 10.32] Settings saved in preset memory

Menu	Description
Selecting output video	Selecting input channels
Output position, size, and masking	Output resolution, Aspect ratio for sink device, Image position, Image size, Background color, Test pattern, Videowall configuration, Videowall position, Frame delay, Synchronization mode, Video synchronization
Output	Output video for when no input video
Picture controls	Output brightness, Output contrast, Output gamma
Output audio	Audio embedding, Audio de-embedding, Audio setting
Bitmap	Bitmap image output, Background color, Aspect ratio, Image position
Multi window output	Window position, Window size, Image position, Image size, Window background color, Window layer order, Window transition effect, Window ON/OFF, Overlay text position, Overlay text size, Window border size, Window border color

## 10.15.6 Start-up setting

Menu  Top→USER PRESET→START-UP

Setting value

**[Table 10.33] Start-up setting**

Setting value	Description
LAST CHANNEL [Default]	Starts with the settings last time the FDX-S powered off.
CHANNEL OFF	Turns channel OFF. Starts with the settings other than channel setting last time the FDX-S powered off.
PRESET MEMORY 1 to PRESET MEMORY 32	Starts with the settings saved in the preset memory. For settings that are not saved in the preset memory, settings last time the FDX-S powered off will be applied.

You can configure which settings will be applied at start-up.

## 10.16 Bitmap

Scan conversion output only

One bitmap file of bitmap files registered in the FDX-S can be displayed on the sink device. No bitmap is registered by default.

A bitmap can be enlarged but cannot be reduced.

【See: 9.3.13 Registering bitmap】

【See: 10.16.6 Memory mode of bitmap file】

### ■ Conditions of bitmap file

The FDX-S supports DIB (Device Independent Bitmap) with a header generally used for Windows, and those files must meet the following requirements:

**[Table 10.34] Bitmap file condition**

Item	Condition
File header	"BITMAPFILEHEADER"
Information header	"BITMAPCOREHEADER" (for OS/2)/ "BITMAPINFOHEADER" (for Windows)
The number of colors	2 colors (monochrome, 1 bit), 16 colors (4 bits), 256 colors (8 bits), 16.77 million colors (TRUE COLOR, 24 bits)
Resolution	2K (4 BITMAPS) mode: 2048x1152 or lower per bitmap 4K (1 BITMAP) mode: 2048x1152 or lower per bitmap*
Compression format	No compression (BI_RGB), 8 bit-run-length compression (BI_RLE8), 4 bit-run-length compression (BI_RLE4)

\*"4K mode": Settable only when 4K@60 scan conversion output board or 4K@60 scan conversion multiview output board is installed.

### 10.16.1 Bitmap image output

Scan conversion output only

Menu	Top→BITMAP→BITMAP OUTPUT
Setting for	ALL, OUT01 to OUTn
Setting value	OFF [Default], 1 to 4 (BITMAP)

You can enable/disable the bitmap image output.  
Unregistered bitmap image cannot be selected.

### 10.16.2 Background color

Scan conversion output only

Menu	Top→BITMAP→BACKGROUND COLOR
Setting for	ALL, OUT01 to OUTn, 1 to 4 (BITMAP)
Setting value	R/G/B: 0 to 255 [Default] R/G/B: 0 (Black)

You can set the background color of the bitmap for each output channel bitmap

If "A" is selected, all "1" to "4" BITMAP can be set.

Select "L" to change the settings of "R", "G" and "B" relatively from the current setting values.

### 10.16.3 Aspect ratio

Scan conversion output only

Menu	Top→BITMAP→ASPECT RATIO
Setting for	ALL, OUT01 to OUTn, 1 to 4 (BITMAP)
Setting value	AUTO [Default], THROUGH, FULL

You can set the aspect ratio of the bitmap for each output channel bitmap.

If "A" is selected, all "1" to "4" BITMAP can be set.

If you select "AUTO", the aspect ratio is kept. However, if bitmap is larger than output resolution, only a portion of the bitmap is displayed.

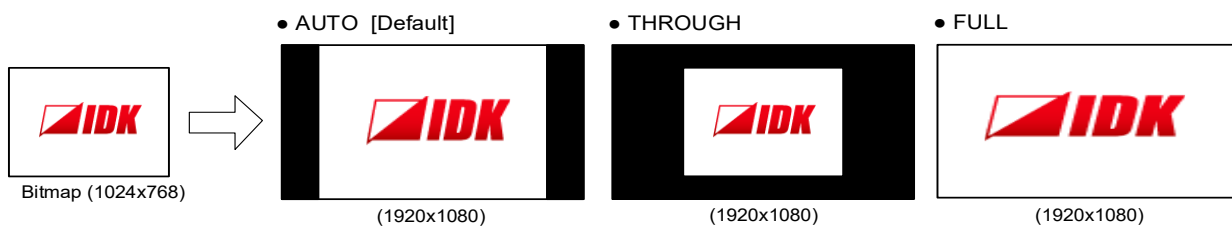

[Fig. 10.30] Setting aspect ratio

## 10.16.4 Image position

Scan conversion output only

Menu	Top→BITMAP→IMAGE POSITION
Setting for	ALL, OUT01 to OUTn, 1 to 4 (BITMAP)
Setting value	CENTER [Default], BOTTOM-RIGHT, TOP-RIGHT, BOTTOM-LEFT, TOP-LEFT

You can set the image position of the bitmap for each output channel bitmap.  
If "A" is selected, all "1" to "4" BITMAP can be set.

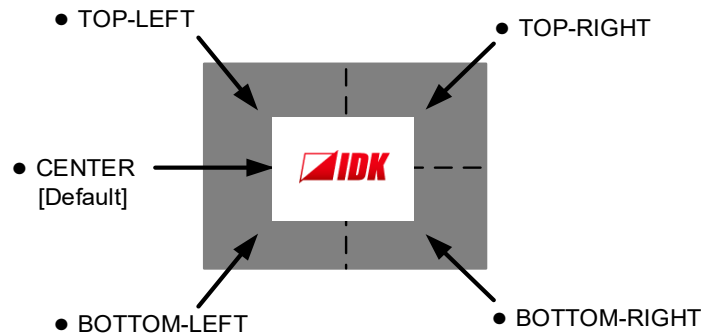

[Fig. 10.31] Position

## 10.16.5 Start-up bitmap output

Scan conversion output only

Menu	Top→BITMAP→START-UP BITMAP
Setting for	ALL, OUT01 to OUTn
Setting value	OFF [Default], 1 to 4 (BITMAP)

You can select the bitmap to be output at startup.  
The selected bitmap ("1" to "4") will be displayed until input video is output.  
Unregistered bitmap image cannot be selected.

## 10.16.6 Memory mode of bitmap file

Scan conversion output only

Menu Top→BITMAP→MEMORY MODE  
 Setting value 2K (4 BITMAPS) [Default], 4K (1 BITMAP)

You can set the memory mode of bitmap file.

If the memory mode is switched, registered bitmap file is deleted.

Press the “MENU/ENTER” button to apply the setting.

**[Table 10.35] Memory mode**

		2K (4 BITMAPS)	4K (1 BITMAP)
Supported board	FDX-SOV4HS	Supported	Not supported
	FDX-SOV4TS	Supported	Not supported
	FDX-SOV4UHS	Supported	Supported
	FDX-SOV2UHS	Supported	Supported
	FDX-SOV1UHM	Supported	Supported
Maximum resolution		2048x1152 per bitmap	4096x2160 per bitmap
Number of registered bitmap files		4	1

## 10.17 Multi window output

You can set multi window.

4K@60 scan conversion multiview output board displays up to four input video signals on a single screen. Up to four windows can be configured, and channels A to D are assigned to each window. To select a source for each window (Windows A to D), see “9.2.2 Selecting output video”.

Example:

If a 4K@60 scan conversion multiview output board is installed to SLOT4 and a source is selected to OUT13, the source is assigned to window A. In the same way, OUT14 – window B, OUT15 – window C, Out14 – window D.

For settings of each window, select the channel number that is displayed on windows A to D (“OUT13A” to “OUT13D”) in addition to OUT13.

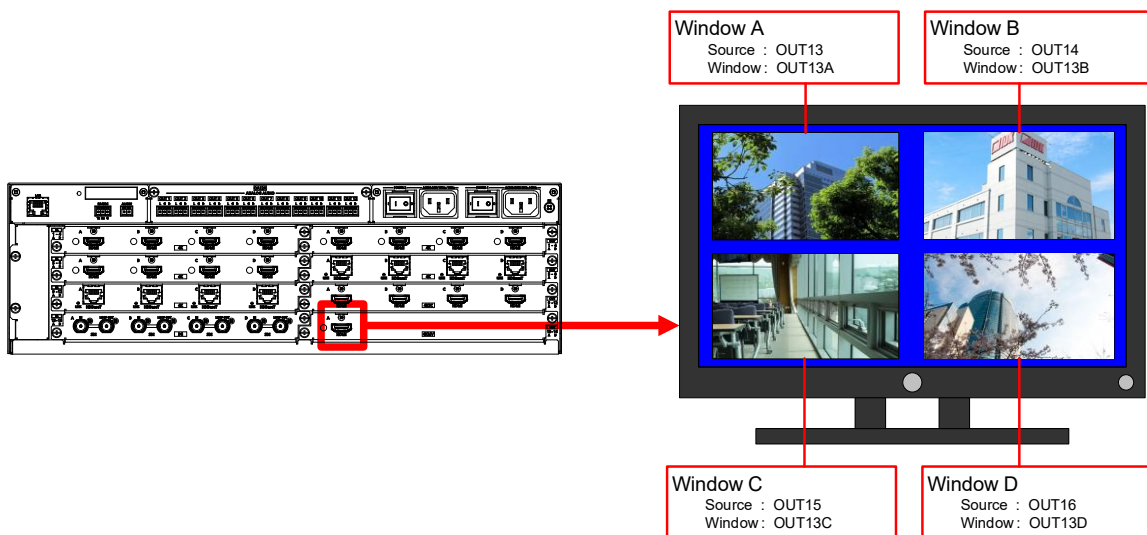

[Fig. 10.32] Example: SLOT4 multi window

### ■ Restrictions on multi window output

For 4K@60 scan conversion multiview output board, if video is output at 4K (4096x2160) or UHD (3840x2160), the YUV4:4:4 signal may be converted and limited from YUV4:4:4 to YUV4:2:2. You can check the output status in the front display and multi window setting menu (WEB browser). In the front display, the setting value is displayed in white. In a WEB browser, the description is displayed in red.

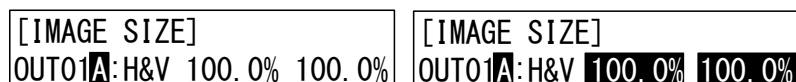

[Fig. 10.33] Example: Not limited (Left) and Limited (Right)

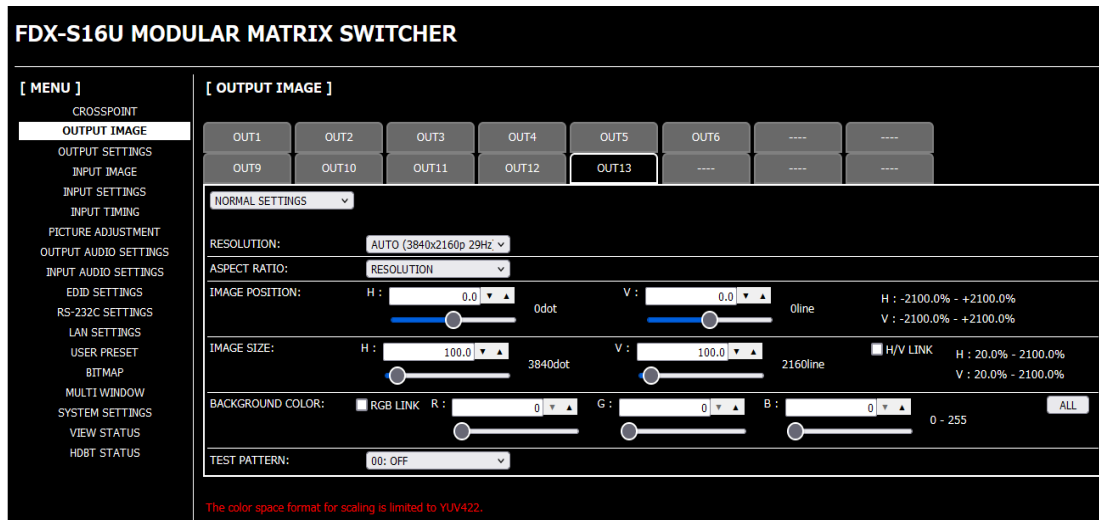

**[Fig. 10.34] Example: Limited**

If the output resolution is limited, the changes may be noticeable depending on video.  
To avoid this restriction, change the settings as follows:

- Change the output resolution to a value other than 4K (4096x2160) or UHD (3840x2160).  
【See: 10.4.1 Output resolution】
- Reduce the sizes of window position and (or) window size.  
【See: 10.17.1 Window position】  
【See: 10.17.2 Window size】
- Reduce the number of windows to be displayed.  
【See: 10.17.9 Window ON/OFF】
- Reduce the sizes of output image position and (or) image size.  
【See: 10.4.3 Image position】  
【See: 10.4.4 Image size】

### 10.17.1 Window position

Scan conversion multiview output only

Menu	Top→MULTI WINDOW→WINDOW POSITION
Setting for	OUT01A to OUTnD
Setting value	Horizontal position : -400.0% to +100.0% [by 0.1%] [Default] 0.0%, 50.0% Vertical position : -400.0% to +100.0% [by 0.1%] [Default] 0.0%, 50.0% By 0.1% from the front menu By 0.01% from the WEB browser and command

You can set the window position.

The window position is based on the output resolution (100%), and it starts from the upper left quadrant.

Images move to as below:

Setting + values : Rightward and downward

Setting - values : Leftward and upward



[Fig. 10.35] Window position

## 10.17.2 Window size

Scan conversion multiview output only

Menu	Top→MULTI WINDOW→WINDOW SIZE
Setting for	OUT01A to OUTnD
Setting value	Horizontal size : 5.0% to 400.0% [by 0.1%] [Default] 50.0% Vertical size : 5.0% to 400.0% [by 0.1%] [Default] 50.0% By 0.1% from the front menu By 0.01% from the WEB browser and command

You can set the window size.

The image size is based on the output resolution (100%), and it starts from the set image position.

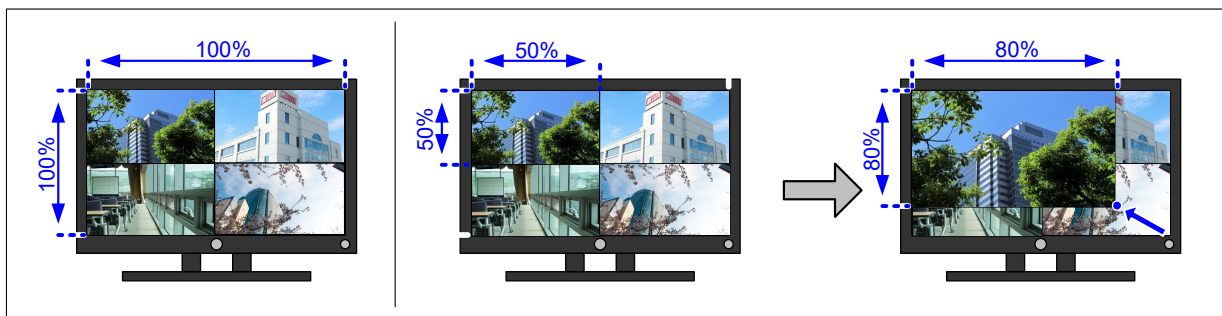

[Fig. 10.36] Window size

## 10.17.3 Aspect Ratio

Scan conversion multiview output only

Menu	Top→MULTI WINDOW→ASPECT RATIO
Setting for	OUT01A to OUTnD
Setting value	

[Table 10.36] Restoring aspect ratio

Setting value	Aspect ratio restoring
AUTO [Default]	Restores the aspect ratio based on the input signals by following the aspect ratio of WINDOW SIZE automatically.
FULL	Displays video on a full WINDOW.

You can set the aspect ratio of the video that is input to WINDOW.

【See: 10.17.2 Window size】

## 10.17.4 Image position

Scan conversion multiview output only

Menu	Top→MULTI WINDOW→IMAGE POSITION		
Setting for	OUT01A to OUTnD		
Setting value	Horizontal position	: -400.0% to +100.0% [by 0.1%]	[Default] 0.0%
	Vertical position	: -400.0% to +100.0% [by 0.1%]	[Default] 0.0%
		By 0.1% from the front menu	
		By 0.01% from the WEB browser and command	

You can set the image position.

The image position is based on the window size (100%), and it starts from the upper left quadrant.

Images move to as below:

Setting + values : Rightward and downward

Setting – values : Leftward and upward



[Fig. 10.37] Image position

## 10.17.5 Image size

Scan conversion multiview output only

Menu	Top→MULTI WINDOW→IMAGE SIZE
Setting for	OUT01A to OUTnD
Setting value	Horizontal size : 20.0% to 400.0% [by 0.1%] [Default] 100.0% Vertical size : 20.0% to 400.0% [by 0.1%] [Default] 100.0% By 0.1% from the front menu By 0.01% from the WEB browser and command

You can set the image size.

The image size is based on the output resolution (100%), and it starts from the set image position.



[Fig. 10.38] Image size

**Note:**

If the horizontal pixel of “**10.4.1 Output resolution**” is set to 2560 pixels or larger and if video signal whose horizontal size is 1400 pixels is input, the signal may not be displayed correctly depending on the horizontal size.

## 10.17.6 Window background color

Scan conversion multiview output only

Menu	Top→MULTI WINDOW→BACKGROUND COLOR
Setting for	ALL, OUT01A to OUTnD
Setting value	R/G/B: 0 to 255 [Default] R/G/B: 0 (Black) Background color: ON [Default], OFF

You can set the background color that is output when an image position and image size are set.

【See: 10.17.4 Image position】

【See: 10.17.5 Image size】

Select “A” to change the settings of “R”, “G” and “B” relatively from the current setting values.

If “OFF” is selected, only input video is displayed.

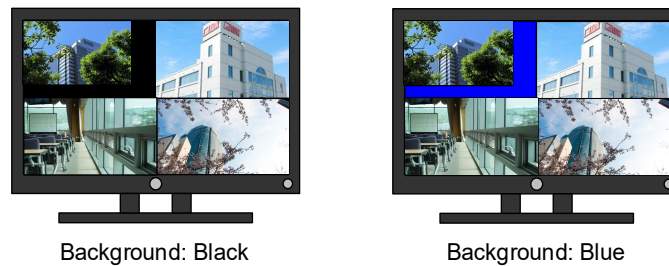

**[Fig. 10.39] Window background color**

For the background color that is output when a window position and window size are set, set in “**10.4.5 Background color**”.

【See: 10.17.1 Window position】

【See: 10.17.2 Window size】

### 10.17.7 Window layer order

Scan conversion multiview output only

Menu	Top→MULTI WINDOW→WINDOW PRIORITY
Setting for	OUT01 to OUTn
Setting value	<ul style="list-style-type: none"> <li>• Priority 1 (Front) A to D [Default] A</li> <li>• Priority 2 A to D [Default] B</li> <li>• Priority 3 A to D [Default] C</li> <li>• Priority 4 (Back) A to D [Default] D</li> </ul>

You can set the window layer order.

Press the “MENU/ENTER” button to apply the setting.

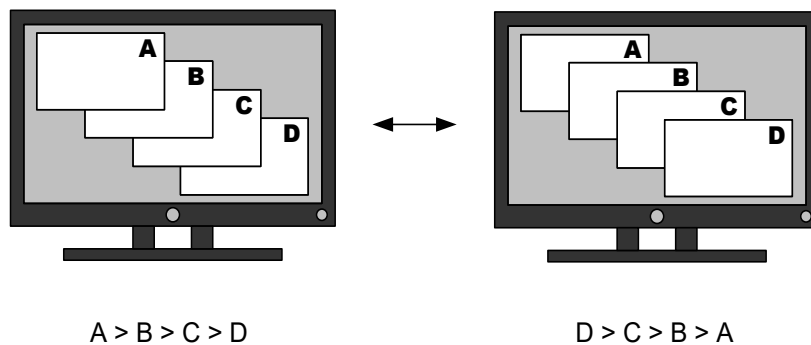

[Fig. 10.40] Layer order

### 10.17.8 Window transition effect

Scan conversion multiview output only

Menu	Top→MULTI WINDOW→VIDEO SWITCHING EFFECT
Setting for	ALL, OUT01A to OUTnD
Setting value	ON [Default], OFF

You can select a transition effect for when the video inputs are switched.

“ON” : Transition effect is enabled; video is switched with FADE OUT-IN.

“OFF” : Transition effect is disabled; video is switched with CUT.

### 10.17.9 Window ON/OFF

Scan conversion multiview output only

Menu	Top→MULTI WINDOW→WINDOW ENABLE
Setting for	ALL, OUT01A to OUTnD
Setting value	ON [Default], OFF

You can display/hide each window.  
 “OFF”: Hides the window.

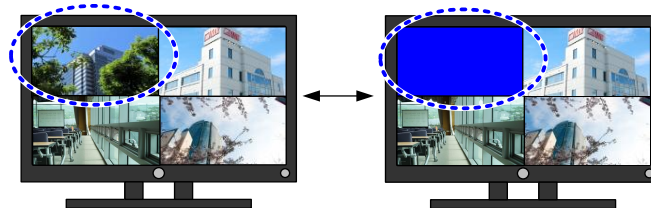

[Fig. 10.41] Hiding window

### 10.17.10 Overlay text position

Scan conversion multiview output only

Menu	Top→MULTI WINDOW→OVERLAY TEXT POSITION		
Setting for	ALL, OUT01A to OUTnD		
Setting value	<ul style="list-style-type: none"> <li>• OFF</li> <li>• TOP-RIGHT</li> <li>• BOTTOM-RIGHT</li> </ul>	<ul style="list-style-type: none"> <li>• TOP-LEFT [Default]</li> <li>• BOTTOM-LEFT</li> </ul>	<ul style="list-style-type: none"> <li>• TOP-CENTER</li> <li>• BOTTOM-CENTER</li> </ul>

You can set the overlay text ON/OFF and its position.  
 The input channel name that can be edited from a WEB browser is displayed as the overlay text.  
 【See: 9.3.11 Editing crosspoint name】

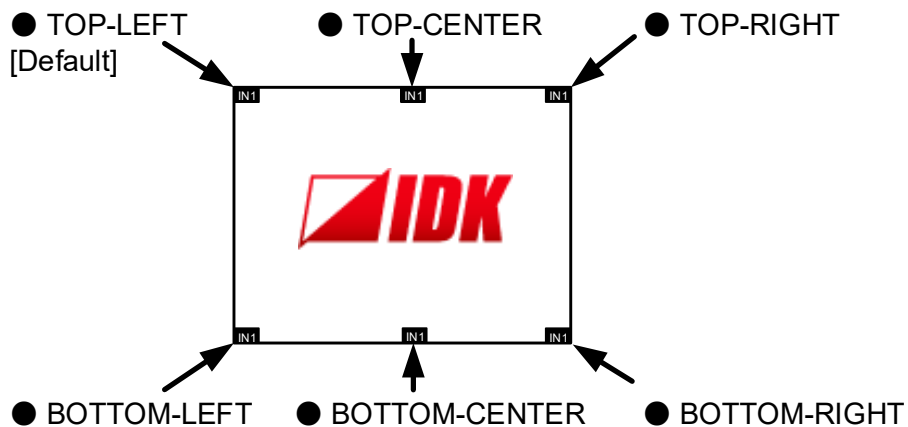

[Fig. 10.42] Overlay text position

### 10.17.11 Overlay text size

Scan conversion multiview output only

Menu	Top→MULTI WINDOW→OVERLAY TEXT SIZE
Setting for	ALL, OUT01A to OUTnD
Setting value	SMALL, LARGE [Default]

You can set the overlay text size.

### 10.17.12 Window border size

Scan conversion multiview output only

Menu	Top→MULTI WINDOW→BORDER SIZE
Setting for	ALL, OUT01A to OUTnD
Setting value	0 pixel to 15 pixels [Default] 0 pixel

You can set the window border (frame) size. The same size is applied to left, right, top, and bottom.

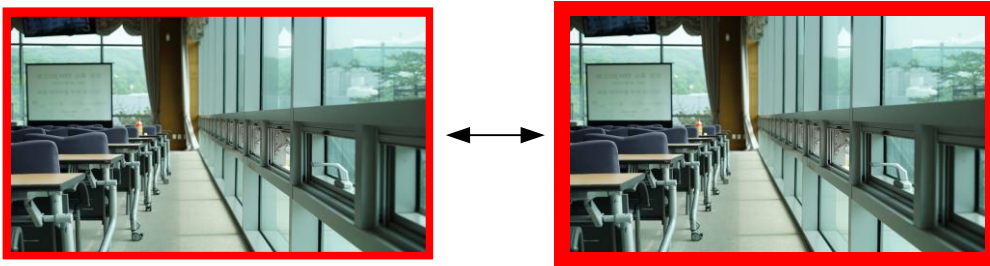

[Fig. 10.43] Window border size

### 10.17.13 Window border color

Scan conversion multiview output only

Menu	Top→MULTI WINDOW→BORDER COLOR
Setting for	ALL, OUT01A to OUTnD
Setting value	R/G/B: 0 to 255 [Default] R/G/B: 0 (Black)

You can set the window border (frame) color.

Select "A" to change the settings of "R", "G" and "B" relatively from the current setting values.

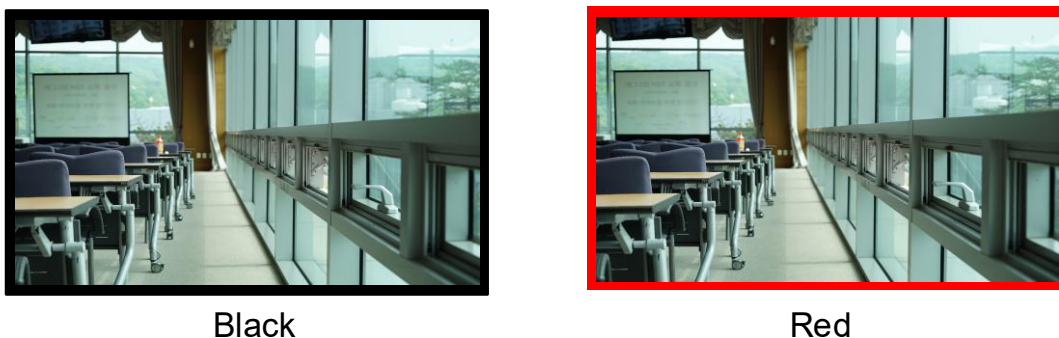

[Fig. 10.44] Window border color

### 10.17.14 Window video synchronization

Scan conversion multiview output only
---------------------------------------

---

Menu	Top→MULTI WINDOW→VIDEO SYNC PROCESSING
Setting for	OUT01A to OUTnD
Setting value	ON [Default], OFF

You can ON (enable)/OFF (disable) the window video synchronization.

The “LEADER” and “FOLLOWER” whose window channel (A to D) is the same will be synchronized. For the channels with the input video are not the same, set this setting to “OFF” (disabled).

**【See: 10.4.11 Video synchronization】**

### 10.17.15 Recalling multi window memory

Scan conversion multiview output only

Menu	Top→MULTI WINDOW→RECALL PATTERN
Setting for	OUT01 to OUTn
Setting value	01 to 10



[Fig. 10.45] Front display (Sample)

You can recall settings that are saved in the multi window memories.

Press the "MENU/ENTER" button to apply the setting.

The following patterns are registered as default.

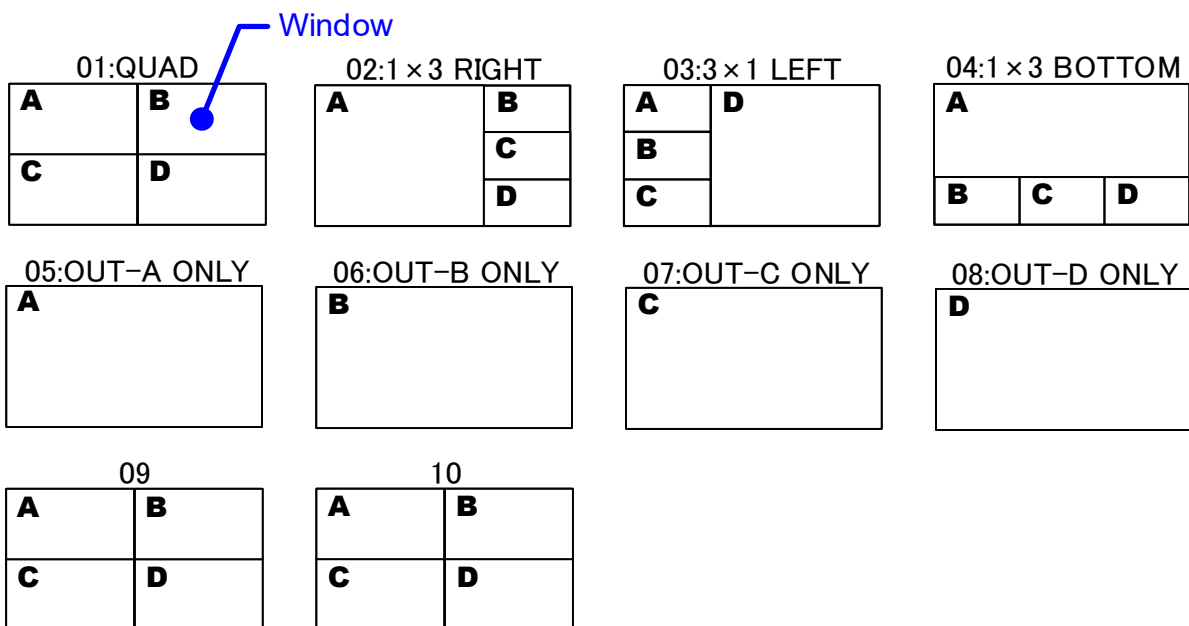

[Fig. 10.46] Multi window memory

**10.17.16 Saving multi window memory**

Scan conversion multiview output only

Menu	Top→MULTI WINDOW→STORE PATTERN
Setting for	OUT01 to OUTn
Setting value	Memory number (01 to 10), memory name

You can save up to 10 multi window memories and name these memories up to 10 characters from ASCII 20 to 7D.

You can skip the naming procedure.

Press the "MENU/ENTER" button to apply the setting.

**[Table 10.37] Settings saved in multi window memory**

Menu	Description
Multi window output	Window position, Window size, Image position, Image size, Window layer order, Window ON/OFF, Overlay text position, Overlay text size, Window border size, Window border color

## 10.18 Configuring FDX-S

---

### 10.18.1 Grouping front panel security lockout

---

Menu Top→SYSTEM SETTINGS→BUTTON LOCK TARGET

Setting for CHANNEL, MENU, PRESET

Setting value

**[Table 10.38] Target buttons of security lockout**

Setting for	Target button	Setting value
CHANNEL	“INPUT SELECT” button, “OUTPUT SELECT” button, “I/O channel selection” buttons	LOCK [Default], UNLOCK
MENU	“MENU/ENTER” button, “Navigation” buttons	LOCK [Default], UNLOCK
PRESET	“PRESET LOAD” button	LOCK [Default], UNLOCK

You can set front panel security lockout that prevents accidental changes to the controller settings.

**【See: 9.2.4 Front panel security lockout】**

### 10.18.2 Beep

---

Menu Top→SYSTEM SETTINGS→BEEP SOUND

Setting value ON [Default], OFF

You can enable/disable the beep tone function (sounding every time you press a front panel button).

### 10.18.3 Alarm

Menu Top→SYSTEM SETTINGS→ALARM

Setting value ON : Enabled [Default]

OFF: Disabled

Rated voltage: DC 24 V

Rated current : 300 mA

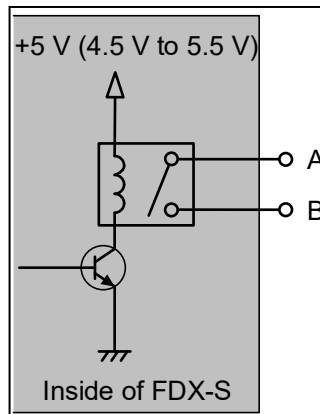

[Fig. 10.47] Alarm output

You can enable/disable the alarm function for detecting problems in power supply voltage, cooling fan, internal temperature, board, or audio board.

In case any problem is detected and the front display shows the top page, the alarm information is displayed and the background light flashes. If “OFF” is selected, front display alarm and background flashing are disabled.



[Fig. 10.48] Alarm page

[Table 10.39] Alarm description

Values to be displayed	Description
MAIN	Appears in case an abnormality in the power supply voltage is detected.
FAN	Appears in case an abnormality in the cooling fan is detected.
TEMP	Appears in case an abnormality in internal temperature is detected.
IN	Appears in case an abnormality in an input board is detected.
OUT	Appears in case an abnormality in an output board is detected.
AD	Appears in case an abnormality in an audio board is detected.

**Note:**

In case an alarm is output, the FDX-S may have problems. Please contact us.

## 10.18.4 Displaying advanced menu

---

Menu	Top→SYSTEM SETTINGS→ADVANCED MENU
Setting value	OFF : Displays normal setting menu [Default] ON : Displays advanced setting menu

You can switch menu display mode: Normal setting menu or Advanced setting menu.

## 10.18.5 Power saving

---

Menu	Top→SYSTEM SETTINGS→POWER SAVE MODE
Setting value	ON [Default], OFF

If you select “ON” and no button function is operated for 10 or 60 seconds, the front display brightness is reduced to approximately 25%. When you operate any button, brightness returns to 100%.

For FDX-S08U/S08 and FDX-S16U/S16, when the power saving mode is activated, the front display menu will return to the top page.

**[Table 10.40] Inactivity time**

Model	Inactivity time
FDX-S08U	60 seconds
FDX-S16U	60 seconds
FDX-S32U	10 seconds
FDX-S64U	10 seconds

### 10.18.6 Top page

Menu Top→SYSTEM SETTINGS→TOP PAGE  
 Setting value OFF [Default], ON

You can view input signal, sink device EDID, and sink device status using ▲, ▼, ◀, and ▶ buttons.

【See: 10.19.1 Input signal status】

【See: 10.19.2 Sink device status】

【See: 10.19.3 Viewing sink device EDID】

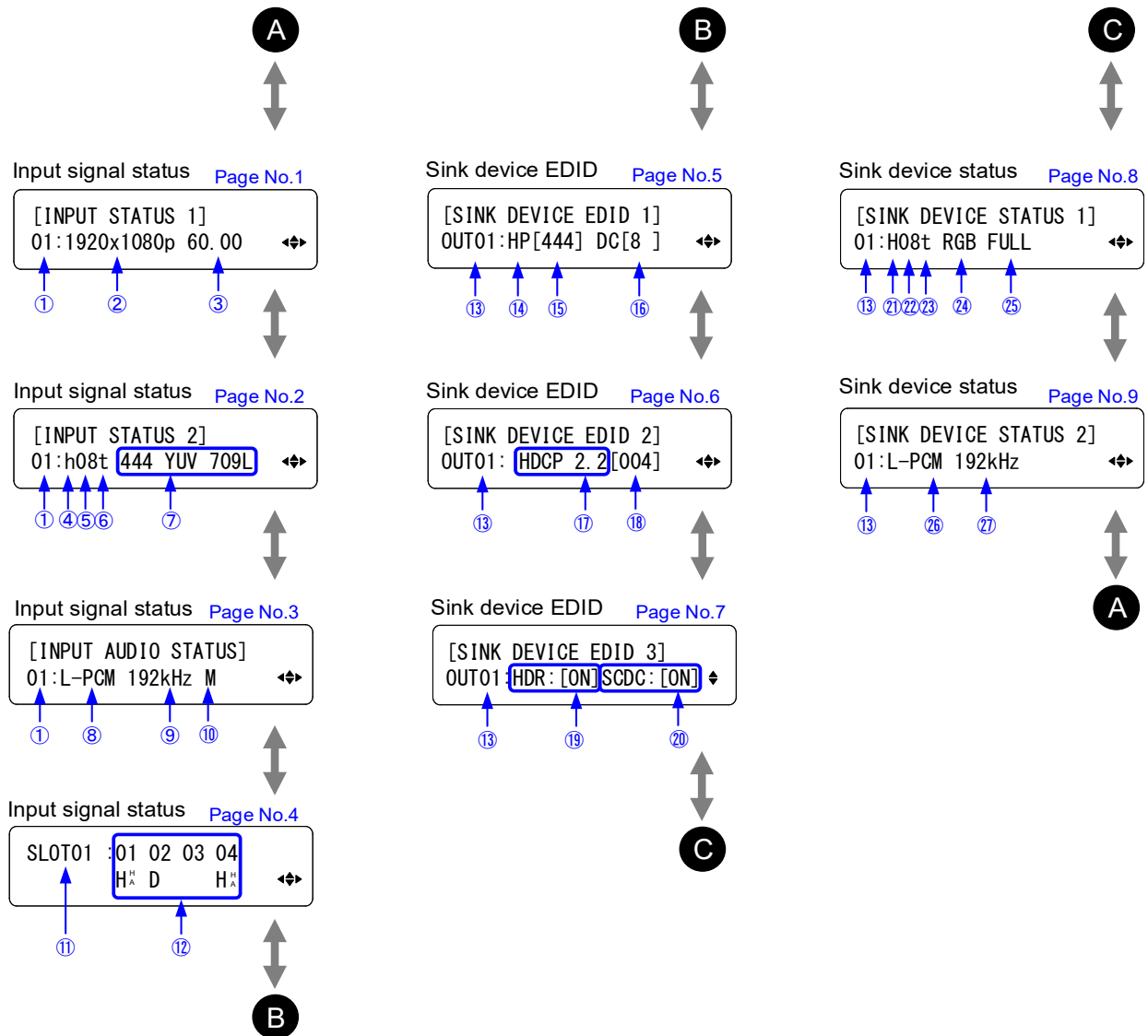

[Fig. 10.49] Top page of front display

[Table 10.41] Top page of front display

[1/4]

Page	Number (① to ⑺)	Description
1	① Input channel number	01 to n
	② Input resolution	Example: 1920x1080p (Input signal resolution)
	③ Input vertical synchronous frequency	Example: 60.00 (Input signal vertical synchronous frequency)
	No signal is input.	No Signal
	No input board is installed.	-----
2	④ Input signal	d : DVI signal · without HDCP, D : DVI signal · with HDCP, h : HDMI signal · without HDCP, H : HDMI signal · with HDCP, s : SDI signal
	⑤ Color depth	08: 24 bit/pixel (8 bit/component) 10: 30 bit/pixel (10 bit/component) 12: 36 bit/pixel (12 bit/component)
	⑥ Stream type	T : HDCP 2.2 stream type 1 t : HDCP 2.2 stream type 0 No value: ④ with HDCP, HDCP 1.4
	⑦ Color space (sampling structure, color range, SDI type, SDI sampling structure)	[If HDMI/DVI/HDBaseT/SDVoE input board is installed] Example: RGB LIMITED (Sampling structure and color range are displayed.)  [If SDI input board is installed] Example: 422 HD Y422 (Sampling structure after HDMI signal conversion, SDI type, SDI sampling structure before HDMI signal conversion)  Sampling structure (Sampling structure after HDMI signal conversion) RGB : RGB 444 : YCbCr 4:4:4 422 : YCbCr 4:2:2 420 : YCbCr 4:2:0  Color range LIMITED : RGB LIMITED FULL : RGB FULL YUV 601L : YUV 601 LIMITED YUV 601F : YUV 601 FULL YUV 709L : YUV 709 LIMITED YUV 709F : YUV 709 FULL XvYCC 601 : xvYCC 601 XvYCC 709 : xvYCC 709 sYCC 601 : sYCC 601 YCC 601 : Adobe YCC 601 Adobe : Adobe RGB

Page	Number (① to ⑳)	Description
2	⑦ Color space (sampling structure, color range, SDI type, SDI sampling structure)	SDI type SD : SD-SDI HD : HD-SDI 3GA : 3G-SDI Level A 3GB : 3G-SDI Level B 2HD : 3G-SDI Level B DualHD 6G : 6G-SDI 12G : 12G-SDI D3G : DualLink 3G-SDI D6G : DualLink 6G-SDI Q3G : QuadLink 3G-SDI --- : Not received unk : Unknown  SDI sampling structure before HDMI signal conversion RGB : RGB 4:4:4 Y444 : YCbCr 4:4:4 Y422 : YCbCr 4:2:2 Y420 : YCbCr 4:2:0 RGBA : RGBA 4:4:4:4 Y444A : YCbCrA 4:4:4:4 Y422A : YCbCrA 4:2:2:4 RGBD : RGBD 4:4:4:4 Y444D : YCbCrD 4:4:4:4 Y422D : YCbCrD 4:2:2:4 XYZ : XYZ 4:4:4 NONE : No payload ID 07,12,13,15 : Unknown
	No signal is input.	No Signal
	No input board is installed.	-----
3	⑧ Input audio signal	L-PCM: LPCM COMPRESSED AUDIO: Compressed audio
	⑨ Input sampling frequency	Example: 192 kHz (Input signal sampling frequency)
	⑩ Audio channel	M: 2.1ch or higher multi audio, No value: Stereo/Mono
	No signal is input.	No Signal
	No input board is installed.	-----
4	⑪ Input board number	SLOT01 to SLOTm
	⑫ Input status for each board	H : HDMI signal, D : DVI signal, S : SDI signal H : with HDCP, A : Audio is input,
5	⑬ Output channel number	OUT01 to OUTn
	⑭ Audio	HC : HDMI monitor that supports compressed audio HP : HDMI monitor that does not support compressed audio (Only LPCM) D : DVI monitor -- : Unknown

Page	Number (① to ⑳)	Description
5	⑮ Color space	RGB : RGB supported 444 : YCbCr 4:4:4 supported 422 : YCbCr 4:2:2 supported --- : Unknown
	⑯ Color depth	8 : 24 bit/pixel (8 bit/component) 10 : 30 bit/pixel (10 bit/component) 12 : 36 bit/pixel (12 bit/component) --- : Unknown
	No sink device is connected.	UNCONNECTED*
	No output board is installed.	-----
6	⑰ HDCP	HDCP 2.2 : HDCP 2.2 supported HDCP 1.4 : HDCP 1.4 supported HDCP OFF: Not supported, ---: Not checked yet
	⑱ HDCP encryption	000 : None, 001 : Being encrypted, 002: Being encrypted, 003 : Being encrypted, 004: Encryption ends normally, 005: Encryption ends abnormally
	No sink device is connected.	UNCONNECTED*
	No output board is installed.	-----
7	⑲ HDR	ON: Supported, --: Not supported
	⑳ SCDC	ON: Supported, --: Not supported
	No sink device is connected.	UNCONNECTED*
	No output board is installed.	-----
8	㉑ Output signal	d : DVI signal • without HDCP, D : DVI signal • with HDCP, h : HDMI signal • without HDCP, H : HDMI signal • with HDCP s : SDI signal
	㉒ Color depth	08: 24 bit/pixel (8 bit/component) 10: 30 bit/pixel (10 bit/component) 12: 36 bit/pixel (12 bit/component)
	㉓ Stream type	T : HDCP 2.2 stream type 1 t : HDCP 2.2 stream type 0 No value: ㉑ with HDCP, HDCP 1.4
	㉔ Color space	RGB : RGB output 444 : YCbCr 4:4:4 output 422 : YCbCr 4:2:2 output 420 : YCbCr 4:2:0 output
	㉕ Color range	FULL : Full range output, LIMITED : Limited range output
	No sink device is connected or no output board is installed.	-----*

\*For SDI output, sink device presence cannot be determined (always shows that a sink device is connected even if no sink device is connected).

Page	Number (① to ⑳)	Description
9	⑳ Output audio signal	L-PCM : LPCM COMPRESSED AUDIO : Compressed audio
	㉑ Output sampling frequency	Example: 192 kHz (Output signal sampling frequency)
	No sink device is connected or no output board is installed.	-----*

\*For SDI output, sink device presence cannot be determined (always shows that a sink device is connected even if no sink device is connected).

### 10.18.7 Channel selection mode

FDX-S08U, FDX-S16U only

Menu Top→SYSTEM SETTINGS→SELECT MODE  
Setting value INPUT→OUTPUT [Default], OUTPUT→INPUT

You can set the switching method.

【See: 9.2.2 Selecting output video】

## 10.19 Status indication

---

### 10.19.1 Input signal status

---

Menu  Top→VIEW STATUS→INPUT STATUS

You can view the input signal status.

【See: 10.18.6 Top page】

### 10.19.2 Sink device status

---

Menu  Top→VIEW STATUS→SINK DEVICE STATUS

You can view the output signal status of sink device connected to video output connectors.

【See: 10.18.6 Top page】

### 10.19.3 Viewing sink device EDID

---

Menu  Top→VIEW STATUS→SINK DEVICE EDID

You can display the EDID information of the sink device that is connected to each video output connector.

【See: 10.18.6 Top page】

## 10.19.4 System status

Menu   Top→VIEW STATUS→SYSTEM STATUS

You can view the power supply voltage, fans, internal temperature, board status, and audio board.



**[Fig. 10.50] System status**

**[Table 10.42] System error**

Displayed value	Description
MAIN	Appears in case an abnormality in the power supply voltage is detected.
FAN	Appears in case an abnormality in the cooling fan is detected.
TEMP	Appears in case an abnormality in internal temperature is detected.
IN	Appears in case an abnormality in an input board is detected.
OUT	Appears in case an abnormality in an output board is detected.
AD	Appears in case an abnormality in an audio board is detected.

**Note:**

In case an alarm is output, the FDX-S may have problems. Please contact us.

## 10.19.5 Viewing board status

Menu   Top→VIEW STATUS→BOARD STATUS

You can view the installed board types, temperature, and board status.

Temperature of audio board is not displayed.

“OK” means normal, and “NG” means abnormal.

<div style="border: 1px solid black; padding: 2px;">[BOARD STATUS]</div> <div style="border: 1px solid black; padding: 2px;">IN01 (4D ) 29.5℃ GOOD ↕</div> <p style="font-size: small;">No abnormality is detected in board</p>	<div style="border: 1px solid black; padding: 2px;">[BOARD STATUS]</div> <div style="border: 1px solid black; padding: 2px;">IN01 (4D ) 29.5℃ NG ↕</div> <p style="font-size: small;">Abnormality is detected in board</p>
---	--

[Fig. 10.51] Board status

[Table 10.43] Board status displayed in front display

P/N	Input/ Output	Description	Value to be displayed
FDX-SIV4UH	Input	4K@60 HDMI/DVI	4D
FDX-SOV4UH	Output		
FDX-SIV4UT	Input	4K@60 HDBaseT	4T
FDX-SOV4UT	Output		
FDX-SIV4UC	Input	4K@60 SDVoE	4C
FDX-SOV4UC	Output		
FDX-SIV4US	Input	12G-SDI/6G-SDI/3G-SDI/HD-SDI	4S
FDX-SOV4US	Output		
FDX-SIV4S	Input	3G-SDI/HD-SDI/SD-SDI	2S
FDX-SOV4UHS	Output	4K@60 HDMI/DVI scan converter	4HS
FDX-SOV2UHS	Output	4K@60 HDMI/DVI scan converter	4DS
FDX-SOV1UHM	Output	4K@60 HDMI/DVI scan converter multiview	4HM
FDX-SOV4HS	Output	1080p HDMI/DVI scan converter	2DS
FDX-SOV4TS	Output	1080p HDBaseT scan converter	2TS

**[Table 10.44] Audio board status**

Model Slot		Normal	Abnormal
FDX-S08U FDX-S16U FDX-S32U		[BOARD STATUS] AUDIO ( 4A) -----℃ GOOD↕	[BOARD STATUS] AUDIO ( 4A) -----℃ NG ↕
FDX-S64U	OPTION A	[BOARD STATUS] AD-A ( 4A) -----℃ GOOD↕	[BOARD STATUS] AD-A ( 4A) -----℃ NG ↕
	OPTION B	[BOARD STATUS] AD-B ( 4A) -----℃ GOOD↕	[BOARD STATUS] AD-B ( 4A) -----℃ NG ↕

**[Table 10.45] Audio board status displayed in front display**

P/N	Input/ Output	Description	Value to be displayed
FDX-SAB4A	Input	4-input analog audio	4A
	Output	4-output analog audio	
FDX-SOA12A	Output	12-output analog audio	12A
FDX-SAB64D	Input	1-input network audio 64 Dante channels	64D
	Output	1-input network audio 64 Dante channels	

**Note:**

In case an abnormality is displayed, the FDX-S may have problems. Please contact us.

## 10.19.6 Fan status

Menu Top→VIEW STATUS→FAN STATUS

You can view fan rotation speed and fan status.  
“OK” means normal, and “NG” means abnormal.

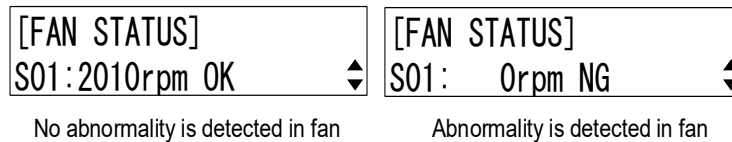

[Fig. 10.52] Fan status

### Notes:

In case the fan stops, power off the FDX-S immediately and contact us. Otherwise, the internal temperature rises, and it may cause fire, problem or electrical shock.

## 10.19.7 Power supply voltage status

Menu Top→VIEW STATUS→POWER STATUS

You can view the power supply voltage status.  
“OK” means normal, and “NG” means abnormal.

[Table 10.46] Power supply voltage status

P/N	Normal	Abnormal
FDX-S08U FDX-S16U FDX-S32U	[POWER STATUS] OK	[POWER STATUS] NG
FDX-S64U	[POWER STATUS] 1A:OK 1B:OK	[POWER STATUS] 1A:NG 1B:OK

### Note:

In case an abnormality is displayed, the FDX-S may have problems. Please contact us.

## 10.19.8 Device information

Menu Top→VIEW STATUS→VERSION

You can view the firmware version.

## 10.20 Factory default list

[1/3]

	Menu	Factory default
CROSS POINT	VIEW SELECTED CHANNELS	OFF
OUTPUT IMAGE	RESOLUTION	AT
	ASPECT RATIO	RESOLUTION
	IMAGE POSITION	H/V: 0.0 %
	IMAGE SIZE	H/V: 100.0 %
	BACKGROUND COLOR	R/G/B: 0 (Black)
	TEST PATTERN	OFF
	VIDEO WALL TYPE	H/V: 01
	VIDEO WALL POSITION	H/V: 01
	VIDEO FRAME DELAY	OFF
	VIDEO SYNC MODE	THROUGH
	VIDEO SYNC PROCESSING	OFF
OUTPUT SETTINGS	SYNC. SIGNAL OUTPUT	OFF
	NO SIGNAL IMAGE	BACK COLOR
	HDCP OUTPUT MODE	FDX-SOV4UHS, FDX-SOV2UHS, FDX-SOV1UHM: HDCP 2.2 FDX-SOV4HS, FDX-SOV4TS: HDCP 1.4
	SIGNAL EQUALIZATION	OFF
	SIGNAL FORMAT	AUTO
	RGB RANGE	AUTO
	HDBT LONG REACH MODE	OFF
	DEEP COLOR	24 Bit
	VIDEO SWITCHING EFFECT	FADE OUT-IN
	EDID ERR. OUTPUT MODE	OFF
	HOTPLUG MASK	OFF
	DDC POWER OUT	ON
	SDI COLOR SPACE CONV.	ON
SDI OUTPUT MODE	SINGLE	
INPUT IMAGE	ASPECT RATIO	AUTO
INPUT SETTINGS	NO INPUT MONITORING	10 Sec
	HDCP INPUT MODE	HDCP 2.2
	HDBT LONG REACH MODE	OFF
	3G-SDI DUAL STREAM	STREAM 1
	SDI INPUT MODE	SINGLE
INPUT TIMING	H START POSITION	0 DOT
	H ACTIVE	0 DOT
	V START POSITION	0 LINE
	V ACTIVE	0 LINE

	Menu	Factory default
PICTURE ADJUSTMENT	OUTPUT BRIGHTNESS	100%
	OUTPUT CONTRAST	R/G/B: 100%
	OUTPUT GAMMA	1.0 NORMAL
	OUTPUT SETTING INIT.	—
	INPUT SHARPNESS	0 NORMAL
	INPUT BRIGHTNESS	100 %
	INPUT CONTRAST	R/G/B: 100%
	INPUT HUE	0 °
	INPUT SATURATION	100%
	INPUT SETTING INIT.	—
OUTPUT AUDIO SETTINGS	MUTE	OFF
	LIP SYNC	0 mSec
	EMBEDDED	DIGITAL
	DE-EMBEDDED	IN01 to INn Straight connection
	AUDIO OUT SELECT	WINDOW A
	SDI AUDIO GROUP	PRI: 1/SEC: 2
INPUT AUDIO SETTINGS	STABLE WAIT	MID
	SDI AUDIO GROUP	PRI: 1/SEC: 2
EDID SETTINGS	RESOLUTION	FDX-SIV4UH: For FDX-S08U/S16U/S32U 42 : 2160p (50/59.94/60, 4:4:4) For FDX-S64U 41 : 2160p (50/59.94/60, 4:2:0) FDX-SIV4UT: 41 : 2160p (50/59.94/60, 4:2:0)
	SINK DEVICE EDID COPY	All 4 COPY DATA is not registered.
	CH. FOR EXTERNAL MODE	OUT 1
	SIGNAL FORMAT	HDMI
	FRAME RATE	60 Hz
	DEEP COLOR	24 Bit
	Linear PCM	48 kHz
	AAC	OFF
	Dolby Digital	OFF
	Dolby Digital Plus	OFF
	Dolby TrueHD	OFF
	DTS	OFF
	DTS-HD	OFF
	SPEAKER CONFIGURATION	2 ch (FL/FR)

	Menu	Factory default
RS-232C SETTINGS	PARAMETERS	9600bps/8/NONE/1
LAN SETTINGS	IP ADDRESS	192.168.1.199
	SUBNET MASK	255.255.255.0
	GATEWAY ADDRESS	0.0.0.0
	MAC ADDRESS	—
	PORT NUMBER	1: 1100/2: 4 CONNECTION
	OUTPUT LAN THROUGH	OFF
	INPUT LAN THROUGH	OFF
	OUTPUT SDVoE DETECTION	ON
	INPUT SDVoE DETECTION	ON
	AUTO DISCONNECT	30 Sec
USER PRESET	RECALL CROSSPOINT	Not registered
	STORE CROSSPOINT	—
	EDIT CROSSPOINT	Output channel (OUT) : OUT Memory name (NAME) : 20 (space)
	RECALL PRESET SETTINGS	Not registered
	STORE PRESET SETTINGS	—
	START-UP	LAST CHANNEL
BITMAP	BITMAP OUTPUT	OFF
	BACKGROUND COLOR	R/G/B: 0 (Black)
	ASPECT RATIO	AUTO
	IMAGE POSITION	CENTER
	START-UP BITMAP	OFF
	MEMORY MODE	2K (4 BITMAPS)
MULTI WINDOW	WINDOW POSITION	WINDOW A H/V: 0.0 %, 0.0% WINDOW B H/V: 50.0 %, 0.0% WINDOW C H/V: 0.0 %, 50.0% WINDOW D H/V: 50.0 %, 50.0%
	WINDOW SIZE	H/V: 50.0 %
	ASPECT RATIO	AUTO
	IMAGE POSITION	H/V: 0.0 %
	IMAGE SIZE	H/V: 100.0 %
	BACKGROUND COLOR	R/G/B: 0 (Black) Background color: ON
	WINDOW PRIORITY	A > B > C > D
	VIDEO SWITCHING EFFECT	ON
	WINDOW ENABLE	ON
	OVERLAY TEXT POSITION	TOP-LEFT
	OVERLAY TEXT SIZE	LARGE
	BORDER SIZE	0 pixel
	BORDER COLOR	R/G/B: 0 (Black)
	VIDEO SYNC PROCESSING	ON
RECALL PATTERN	8 patterns	
STORE PATTERN	—	

	Menu	Factory default
SYSTEM SETTINGS	BUTTON LOCK TARGET	MENU/CHANNEL/PRESET: LOCK
	BEEP SOUND	ON
	ALARM	ON
	ADVANCED MENU	OFF
	POWER SAVE MODE	ON
	TOP PAGE	OFF
	SELECT MODE	INPUT→OUTPUT
VIEW STATUS	INPUT STATUS	—
	SINK DEVICE STATUS	—
	SINK DEVICE EDID	—
	SYSTEM STATUS	—
	BOARD STATUS	—
	FAN STATUS	—
	POWER STATUS	—
VERSION	—	

## 11 License

The following table shows the licensed third-party software packages used by the FDX-S. Transferring, copying, disassembling, decompiling, or reverse-engineering the included software other than open source software that is licensed by GPL, LGPL, or other licenses are prohibited.

OSS	License	URL
FreeRTOS	MIT	<a href="https://github.com/aws/amazon-freertos/blob/main/LICENSE">https://github.com/aws/amazon-freertos/blob/main/LICENSE</a>
lwIP	Modified BSD	<a href="https://savannah.nongnu.org/projects/lwip/">https://savannah.nongnu.org/projects/lwip/</a>
Eclipse ThreadX RTOS	MIT	<a href="https://github.com/eclipse-threadx/threadx/blob/master/LICENSE.txt">https://github.com/eclipse-threadx/threadx/blob/master/LICENSE.txt</a>
Eclipse ThreadX NetX Duo	MIT	<a href="https://github.com/eclipse-threadx/netxdm/blob/master/LICENSE.txt">https://github.com/eclipse-threadx/netxdm/blob/master/LICENSE.txt</a>
Eclipse ThreadX filex	MIT	<a href="https://github.com/eclipse-threadx/filex/blob/master/LICENSE.txt">https://github.com/eclipse-threadx/filex/blob/master/LICENSE.txt</a>
mbedtls	Apache License Version 2.0	<a href="https://github.com/Mbed-TLS/mbedtls/blob/development/LICENSE">https://github.com/Mbed-TLS/mbedtls/blob/development/LICENSE</a>

## 12 Product specification

### 12.1 FDX-S08U

Item	Description	
Input board	2 slots (Up to 8 inputs)	
Output board	2 slots (Up to 8 outputs)	
Audio board	1 slot (Up to 32 stereo channels)	
Transmission signal	Video	Up to 4K@60 (4:4:4)
	Audio	Multi-channel LPCM up to 8 channels
	Control	Up to 38.4 kbps of RS-232C, Up to 100Base-TX of LAN
Instant Alert output	1 port/captive screw (2-pin) Non-voltage contact input up to DC 24 V 300 mA Monitoring power supply voltage, fans, internal temperature, board, and audio board status	
Control	RS-232C	1 port/captive screw (3-pin), full duplex, up to 38.4 kbps
	LAN	1 port/RJ-45 10Base-T/100Base-TX (Auto Negotiation), Auto MDI/MDI-X
Functions	I/O board, audio board, CPU board, fan unit, and power unit can be replaced without removing from rack, Preset memory (32 settings), Last memory, Button security lockout, System check, WEB browser control, Status notification, HDBaseT status display	
General	Power	100 - 240 VAC $\pm$ 10%, 50 Hz/60 Hz $\pm$ 3 Hz
	Power consumption	About 17 Watts
	Dimensions	16.9 (W) $\times$ 3.5 (H) $\times$ 15.7 (D)" (430 (W) $\times$ 88 (H) $\times$ 400 (D) mm) (2U high) (Excluding connectors and the like)
	Weight	20.5 lbs. (9.3 kg) (With redundant power supply: 21.4 lbs. (9.7 kg))
	Temperature	Operating : 32°F to 104°F (0°C to +40°C) Storage : -4°F to +176°F (-20°C to +80°C)
	Humidity	Operating/Storage: 20% to 90% (Non Condensing)

#### ■ I/O boards

Item	Parts Number	Description
Input board	FDX-SIV4UH	4 inputs 4K@60 HDCP 2.2 HDMI/DVI
	FDX-SIV4UT	4 inputs 4K@60 HDCP 2.2 HDBaseT
	FDX-SIV4US	4 inputs 12G-SDI/6G-SDI/3G-SDI/HD-SDI
	FDX-SIV4UC	4 inputs 4K@60 HDCP 2.2 SDVoE
	FDX-SIV4S	4 inputs 3G-SDI/HD-SDI/SD-SDI
Output board	FDX-SOV4UH	4 outputs 4K@60 HDCP 2.2 HDMI/DVI
	FDX-SOV4UT	4 outputs 4K@60 HDCP 2.2 HDBaseT
	FDX-SOV4US	4 outputs 12G-SDI/6G-SDI/3G-SDI/HD-SDI
	FDX-SOV4UC	4 outputs 4K@60 HDCP 2.2 SDVoE
	FDX-SOV4UHS	4 outputs 4K@60 HDCP 2.2 HDMI/DVI scan converter
	FDX-SOV2UHS	2 outputs 4K@60 HDCP 2.2 HDMI/DVI scan converter
	FDX-SOV1UHM	1 output 4K@60 HDCP 2.2 HDMI/DVI scan converter multiview
	FDX-SOV4HS	4 outputs 1080p HDCP 1.4 HDMI/DVI scan converter
	FDX-SOV4TS	4 outputs 1080p HDCP 1.4 HDBaseT scan converter

#### ■ Audio board

Item	Parts Number	Description
Audio board	FDX-SAB4A	4 inputs Unbalanced 4 outputs Balanced/Unbalanced
	FDX-SOA12A	12 outputs Unbalanced
	FDX-SAB64D	1 input/output 64 Dante protocol channels (32 stereo channels)

#### ■ Redundant power supply unit

Item	Parts Number	Description
Redundant power supply unit	FDX-SRP08	Redundant power unit with two independent power connectors

## 12.2 FDX-S16U

Item	Description	
Input board	4 slots (Up to 16 inputs)	
Output board	4 slots (Up to 16 outputs)	
Audio board	1 slot (Up to 32 stereo channels)	
Transmission signal	Video	Up to 4K@60 (4:4:4)
	Audio	Multi-channel LPCM up to 8 channels
	Control	Up to 38.4 kbps of RS-232C, Up to 100Base-TX of LAN
Instant Alert output	1 port/captive screw (2-pin) Non-voltage contact input up to DC 24 V 300 mA Monitoring power supply voltage, fans, internal temperature, board, and audio board status	
Control	RS-232C	1 port/captive screw (3-pin), full duplex, up to 38.4 kbps
	LAN	1 port/RJ-45 10Base-T/100Base-TX (Auto Negotiation), Auto MDI/MDI-X
Functions	I/O board, audio board, CPU board, fan unit, and power unit can be replaced without removing from rack, Preset memory (32 settings), Last memory, Button security lockout, System check, WEB browser control, Status notification, HDBaseT status display	
General	Power	100 - 240 VAC ±10%, 50 Hz/60 Hz ±3 Hz
	Power consumption	About 30 Watts
	Dimensions	16.9 (W) × 5.2 (H) × 15.7 (D)" (430 (W) × 132 (H) × 400 (D) mm) (3U high) (Excluding connectors and the like)
	Weight	26.9 lbs. (12.2 kg) (With redundant power supply: 28.9 lbs. (13.1 kg))
	Temperature	Operating : 32°F to 104°F (0°C to +40°C) Storage : -4°F to +176°F (-20°C to +80°C)
	Humidity	Operating/Storage: 20% to 90% (Non Condensing)

### ■ I/O boards

Item	Parts Number	Description
Input board	FDX-SIV4UH	4 inputs 4K@60 HDCP 2.2 HDMI/DVI
	FDX-SIV4UT	4 inputs 4K@60 HDCP 2.2 HDBaseT
	FDX-SIV4US	4 inputs 12G-SDI/6G-SDI/3G-SDI/HD-SDI
	FDX-SIV4UC	4 inputs 4K@60 HDCP 2.2 SDVoE
	FDX-SIV4S	4 inputs 3G-SDI/HD-SDI/SD-SDI
Output board	FDX-SOV4UH	4 outputs 4K@60 HDCP 2.2 HDMI/DVI
	FDX-SOV4UT	4 outputs 4K@60 HDCP 2.2 HDBaseT
	FDX-SOV4US	4 outputs 12G-SDI/6G-SDI/3G-SDI/HD-SDI
	FDX-SOV4UC	4 outputs 4K@60 HDCP 2.2 SDVoE
	FDX-SOV4UHS	4 outputs 4K@60 HDCP 2.2 HDMI/DVI scan converter
	FDX-SOV2UHS	2 outputs 4K@60 HDCP 2.2 HDMI/DVI scan converter
	FDX-SOV1UHM	1 output 4K@60 HDCP 2.2 HDMI/DVI scan converter multiview
	FDX-SOV4HS	4 outputs 1080p HDCP 1.4 HDMI/DVI scan converter
	FDX-SOV4TS	4 outputs 1080p HDCP 1.4 HDBaseT scan converter

### ■ Audio board

Item	Parts Number	Description
Audio board	FDX-SAB4A	4 inputs Unbalanced 4 outputs Balanced/Unbalanced
	FDX-SOA12A	12 outputs Unbalanced
	FDX-SAB64D	1 input/output 64 Dante protocol channels (32 stereo channels)

### ■ Redundant power supply unit

Item	Parts Number	Description
Redundant power supply unit	FDX-SRP16	Redundant power unit with two independent power connectors

## 12.3 FDX-S32U

Item	Description	
Input board	8 slots (Up to 32 inputs)	
Output board	8 slots (Up to 32 outputs)	
Audio board	1 slot (Up to 32 stereo channels)	
Transmission signal	Video	Up to 4K@60 (4:4:4)
	Audio	Multi-channel LPCM up to 8 channels
	Control	Up to 38.4 kbps of RS-232C, Up to 100Base-TX of LAN
Instant Alert output	1 port/captive screw (2-pin) Non-voltage contact input up to DC 24 V 300 mA Monitoring power supply voltage, fans, internal temperature, board, and audio board status	
Control	RS-232C	1 port/captive screw (3-pin), full duplex, up to 38.4 kbps
	LAN	1 port/RJ-45 10Base-T/100Base-TX (Auto Negotiation), Auto MDI/MDI-X
Functions	I/O board, audio board, CPU board, fan unit, and power unit can be replaced without removing from rack, Preset memory (32 settings), Last memory, Button security lockout, System check, WEB browser control, Status notification, HDBaseT status display	
General	Power	100 - 240 VAC $\pm$ 10%, 50 Hz/60 Hz $\pm$ 3 Hz
	Power consumption	About 42 Watts
	Dimensions	16.9 (W) $\times$ 8.7 (H) $\times$ 15.7 (D)" (430 (W) $\times$ 221 (H) $\times$ 400 (D) mm) (5U high) (Excluding connectors and the like)
	Weight	32.8 lbs. (14.9 kg) (With redundant power supply: 35.9 lbs. (16.3 kg))
	Temperature	Operating : 32°F to 104°F (0°C to +40°C) Storage : -4°F to +176°F (-20°C to +80°C)
	Humidity	Operating/Storage: 20% to 90% (Non Condensing)

### ■ I/O boards

Item	Parts Number	Description
Input board	FDX-SIV4UH	4 inputs 4K@60 HDCP 2.2 HDMI/DVI
	FDX-SIV4UT	4 inputs 4K@60 HDCP 2.2 HDBaseT
	FDX-SIV4US	4 inputs 12G-SDI/6G-SDI/3G-SDI/HD-SDI
	FDX-SIV4UC	4 inputs 4K@60 HDCP 2.2 SDVoE
	FDX-SIV4S	4 inputs 3G-SDI/HD-SDI/SD-SDI
Output board	FDX-SOV4UH	4 outputs 4K@60 HDCP 2.2 HDMI/DVI
	FDX-SOV4UT	4 outputs 4K@60 HDCP 2.2 HDBaseT
	FDX-SOV4US	4 outputs 12G-SDI/6G-SDI/3G-SDI/HD-SDI
	FDX-SOV4UC	4 outputs 4K@60 HDCP 2.2 SDVoE
	FDX-SOV4UHS	4 outputs 4K@60 HDCP 2.2 HDMI/DVI scan converter
	FDX-SOV2UHS	2 outputs 4K@60 HDCP 2.2 HDMI/DVI scan converter
	FDX-SOV1UHM	1 output 4K@60 HDCP 2.2 HDMI/DVI scan converter multiview
	FDX-SOV4HS	4 outputs 1080p HDCP 1.4 HDMI/DVI scan converter
	FDX-SOV4TS	4 outputs 1080p HDCP 1.4 HDBaseT scan converter

### ■ Audio board

Item	Parts Number	Description
Audio board	FDX-SAB4A	4 inputs Unbalanced 4 outputs Balanced/Unbalanced
	FDX-SOA12A	12 outputs Unbalanced
	FDX-SAB64D	1 input/output 64 Dante protocol channels (32 stereo channels)

### ■ Redundant power supply unit

Item	Parts Number	Description
Redundant power supply unit	FDX-SRP32	Redundant power unit with two independent power connectors

## 12.4 FDX-S64U

Item	Description	
Input board	16 slots (Up to 64 inputs)	
Output board	16 slots (Up to 64 outputs)	
Audio board	2 slots (Up to 64 stereo channels)	
Transmission signal	Video	Up to 4K@60 (4:2:0)
	Audio	Multi-channel LPCM up to 8 channels
	Control	Up to 38.4 kbps of RS-232C, Up to 100Base-TX of LAN
Instant Alert output	1 port/captive screw (2-pin) Non-voltage contact input up to DC 24 V 300 mA Monitoring power supply voltage, fans, internal temperature, board, and audio board status	
Control	RS-232C	1 port/captive screw (3-pin), full duplex, up to 38.4 kbps
	LAN	1 port/RJ-45 10Base-T/100Base-TX (Auto Negotiation), Auto MDI/MDI-X
Functions	I/O board, audio board, CPU board, fan unit, and power unit can be replaced without removing from rack, Preset memory (32 settings), Last memory, Button security lockout, System check, WEB browser control, Status notification, HDBaseT status display	
General	Power	100 - 240 VAC ±10%, 50 Hz/60 Hz ±3 Hz (*1)
	Power consumption	About 82 Watts
	Dimensions	16.9 (W) × 17.4 (H) × 15.7 (D)" (430 (W) × 443 (H) × 400 (D) mm) (10U high) (Excluding connectors and the like)
	Weight	56.4 lbs. (25.6 kg) (With redundant power supply: 64.8 lbs. (29.4 kg))
	Temperature	Operating : 32°F to 104°F (0°C to +40°C) Storage : -4°F to +176°F (-20°C to +80°C)
	Humidity	Operating/Storage: 20% to 90% (Non Condensing)

\*1 AC 200 V is required for some combination of boards. Please contact us for details.

### ■ I/O boards

Item	Parts Number	Description
Input board	FDX-SIV4UH	4 inputs 4K@60 HDCP 2.2 HDMI/DVI
	FDX-SIV4UT	4 inputs 4K@60 HDCP 2.2 HDBaseT
	FDX-SIV4US	4 inputs 12G-SDI/6G-SDI/3G-SDI/HD-SDI
	FDX-SIV4UC	4 inputs 4K@60 HDCP 2.2 SDVoE
	FDX-SIV4S	4 inputs 3G-SDI/HD-SDI/SD-SDI
Output board	FDX-SOV4UH	4 outputs 4K@60 HDCP 2.2 HDMI/DVI
	FDX-SOV4UT	4 outputs 4K@60 HDCP 2.2 HDBaseT
	FDX-SOV4US	4 outputs 12G-SDI/6G-SDI/3G-SDI/HD-SDI
	FDX-SOV4UC	4 outputs 4K@60 HDCP 2.2 SDVoE
	FDX-SOV4UHS	4 outputs 4K@60 HDCP 2.2 HDMI/DVI scan converter
	FDX-SOV2UHS	2 outputs 4K@60 HDCP 2.2 HDMI/DVI scan converter
	FDX-SOV1UHM	1 output 4K@60 HDCP 2.2 HDMI/DVI scan converter multiview
	FDX-SOV4HS	4 outputs 1080p HDCP 1.4 HDMI/DVI scan converter
	FDX-SOV4TS	4 outputs 1080p HDCP 1.4 HDBaseT scan converter

### ■ Audio board

Item	Parts Number	Description
Audio board	FDX-SAB4A	4 inputs Unbalanced 4 outputs Balanced/Unbalanced
	FDX-SQA12A	12 outputs Unbalanced
	FDX-SAB64D	1 input/output 64 Dante protocol channels (32 stereo channels)

### ■ Redundant power supply unit

Item	Parts Number	Description
Redundant power supply unit	FDX-SRP64	Redundant power unit with two independent power connectors

## 12.5 FDX-SIV4UH

Item		Description
Input		4 inputs
Video	HDMI/DVI	HDMI/DVI 1.0 TMDS single link, HDCP 1.4/2.2 TMDS clock: 25 MHz to 300 MHz, TMDS data rate: 0.75 Gbps to 18 Gbps 36 bit Deep Color, x.v.Color, 3D (*1), HDR (*2) For 4K@50/59.94/60 RGB/YCbCr 4:4:4, 24 bit is supported. ARC/HEC/CEC are not supported. EDID emulation
	Format	VGA to 4K (Dot clock: 25 MHz to 600 MHz) 480i / 480p / 576i / 576p / 720p / 1080i / 1080p / 4K For 4K formats, 24 Hz/25 Hz/30 Hz/50 Hz (4:4:4)/60 Hz (4:4:4) are supported.
Audio	Digital	Multi-channel LPCM up to 8 channels Sampling frequency: 32 kHz to 192 kHz, Sample size: 16 bit to 24 bit Reference level: -20 dBFS, Max. input level: 0 dBFS
Connector		Female HDMI Type A (19-pin)
Maximum transmission distances		98 ft. (30 m) (1080p@60), 66 ft. (20 m) (4K@60 4:2:0), 39 ft. (12 m) (4K@60 4:4:4) (*3)
General	Power consumption	About 14 Watts
	Weight	0.7 lbs. (0.3 kg)
	Temperature	Operating : 32°F to 104°F (0°C to +40°C) Storage : -4°F to +176°F (-20°C to +80°C)
	Humidity	Operating/Storage: 20% to 90% (Non Condensing)

- \*1 3D is supported if external EDID is selected while a 3D-supported sink device is connected for EDID setting or if copied EDID of 3D-supported sink device is selected for EDID setting.
- \*2 HDR is supported if external EDID is selected while an HDR-supported sink device is connected for EDID setting or if copied EDID of an HDR-supported sink device is selected for EDID setting.
- \*3 The maximum cable distance varies depending on the connected devices and was measured under following conditions:  
 • 1080p@60 : When IDK's 24 AWG cable was used and signals of 1080p@60 24 bit/pixel (8 bit/component) was input.  
 • 4K@60 4:2:0 : When IDK's 24 AWG cable was used and signals of 4K@60 4:2:0 24 bit/pixel (8 bit/component) was input.  
 • 4K@60 4:4:4 : When IDK's 18 Gbps supported cable was used and signals of 4K@60 4:4:4 24 bit/pixel (8 bit/component) was input.  
 The maximum cable distance depends on the connected devices. The distance may not be extended with some device combinations, cabling method, or other manufacturer's cable. Video may be disturbed or may not be output even if signals are within the range mentioned above.

## 12.6 FDX-SIV4UT

Item		Description
Input		4 inputs
Video	HDBaseT	HDBaseT HDCP 1.4/2.2 36 bit Deep Color, x.v.Color, 3D (*1), HDR (*2) For WQHD, WQXGA, and 4K formats, 24 bit is supported. ARC/HEC/CEC are not supported. EDID emulation, RS-232C/LAN
	Format	VGA to 4K (Dot clock: 25 MHz to 600 MHz) For WQHD/WQXGA, only Reduced Blanking is supported. 480i / 480p / 576i / 576p / 720p / 1080i / 1080p / 4K For 4K formats, 24 Hz/25 Hz/30 Hz/50 Hz (4:2:0)/60 Hz (4:2:0) are supported.
Audio	Digital	Multi-channel LPCM up to 8 channels Sampling frequency: 32 kHz to 192 kHz, Sample size: 16 bit to 24 bit Reference level: -20 dBFS, Max. input level: 0 dBFS
Connector		RJ-45 (*3)
Cable		CAT.5E HDC, Cat5e UTP/STP, Cat6 UTP/STP (T568A/T568B straight-through)
Maximum transmission distances		328 ft. (100 m), 492 ft. (150 m) (Long reach mode is used) (*4)
General	Power consumption	About 31 Watts
	Weight	1.1 lbs. (0.5 kg)
	Temperature	Operating : 32°F to 104°F (0°C to +40°C) Storage : -4°F to +176°F (-20°C to +80°C)
	Humidity	Operating/Storage: 20% to 90% (Non Condensing)

- \*1 3D is supported if external EDID is selected while a 3D-supported sink device is connected for EDID setting or if copied EDID of 3D-supported sink device is selected for EDID setting.
- \*2 HDR is supported if external EDID is selected while an HDR-supported sink device is connected for EDID setting or if copied EDID of an HDR-supported sink device is selected for EDID setting.
- \*3 RJ-45 (HDBaseT connector) is only for extending digital video and audio signals over a Cat5e/Cat6 cable. Use it with IDK's HDBaseT Products. Do not use for LAN devices.
- \*4 The maximum transmission distance was obtained when IDK's CAT.5E HDC cable was used. The distance may not be extended with some device combinations, cabling method, or other manufacturer's cable. Video may be disturbed or may not be output even if signals are within the range mentioned above. The maximum transmission distance is the shorter distance of connected HDBaseT product or sink device's maximum transmission distance. Up to 492 ft. (150 m): 1080p (24 bit) in Long reach mode. For Long reach mode, use IDK's HDBaseT Products that supports 328 ft. (100 m) or longer.

## 12.7 FDX-SIV4US

Item		Description
Input		4 inputs (SINGLE LINK) 2 inputs (DUAL LINK) 1 input (QUAD LINK) Each input connector has a loop-through output connector. Note: When the FDX-S is powered on, SDI input signals are output from SDI loop-through output connectors.
Video	SDI	12G-SDI/6G-SDI/3G-SDI/HD-SDI NRZI/NRZ, 0.8 V <sub>[p-p]</sub> /75 Ω SMPTE ST-2082-1 (12G-SDI)/SMPTE ST-2081-1 (6G-SDI)/SMPTE 424M (3G-SDI)/SMPTE 292M (HD-SDI) For FDX-S64U, 12G-SDI is not supported.
	Format	720p / 1080i / 1080p / 4K 3G-SDI signals : Only Level A Multiple link : 2SI (2 Sample Interleave) 720p : 23.98 Hz and 24 Hz are not supported.
Audio	Digital	LPCM up to 8 channels (Selecting 2 groups of audio groups 1 to 4) Sampling frequency: 48 kHz/96kHz, Sample size: 16 bit to 24 bit Reference level: -20 dBFS, Max. input level: 0 dBFS
Connector		BNC
Cable		75 Ω coaxial cable for high frequency signal
Maximum transmission distances (*1)		With 1505A (BELDEN RG-59), HD-SDI: 7.9 ft. (200 m) 3G-SDI: 5.1 ft. (130 m) With 1694A (BELDEN RG-6), HD-SDI: 820 ft. (250 m) 3G-SDI: 525 ft. (160 m) 6G-SDI: 262 ft. (80 m) 12G-SDI: 197 ft. (60 m)
Function		12G-SDI/6G-SDI/3G-SDI/HD-SDI can be mixed (When gearbox function (*2) is disabled) Gearbox (DUAL LINK 3G: equivalent to 6G-SDI; DUAL LINK 6G 2SI: equivalent to 12G-SDI; QUAD LINK 3G LEVEL A 2SI: equivalent to 12G-SDI) For FDX-S64U, SDI input gearbox mode is not supported.
General	Power consumption	About 35 Watts
	Weight	1.3 lbs. (0.6 kg)
	Temperature	Operating : 32°F to 104°F (0°C to +40°C) Storage : -4°F to +176°F (-20°C to +80°C)
	Humidity	Operating/Storage: 20% to 90% (Non Condensing)

\*1 The maximum distances may be shorten depending on the quality of cable. Please make sure that the cable is long enough.

\*2 Can be enabled/disable separately for each board, and it converts the following signals: from DUAL LINK 3G-SDI to SINGLE LINK 6G-SDI; from DUAL LINK 6G-SDI to SINGLE LINK 12G-SDI; from QUAD LINK 3G-SDI to SINGLE LINK 12G-SDI.

## 12.8 FDX-SIV4UC

Item		Description
Input		4 inputs
Video	10GbE (*1)	SDVoE, AES-128 36 bit Deep Color, HDR (*2) For 4K@50/59.94/60 RGB/YCbCr 4:4:4, 24 bit is supported. x.v.Color/3D/ARC/HEC/CEC are not supported. EDID emulation, RS-232C/LAN
	Format	VGA to 4K (Dot clock: 25 MHz to 600 MHz) For WQHD/WQXGA, only Reduced Blanking is supported. 480i / 480p / 576i / 576p / 720p / 1080i / 1080p / 4K For 4K formats, 24 Hz/25 Hz/30 Hz/50 Hz (4:4:4)/60 Hz (4:4:4) are supported.
Audio	Digital	Multi-channel LPCM up to 8 channels Sampling frequency: 32 kHz to 192 kHz, Sample size: 16 bit to 24 bit Reference level: -20 dBFS, Max. input level: 0 dBFS
Connector		RJ-45
Cable		CAT6A (STP)
Maximum transmission distance		328 ft. (100 m) (*3)
General	Power consumption	About 42 Watts
	Weight	1.3 lbs. (0.6 kg)
	Temperature	Operating : 32°F to 104°F (0°C to +40°C) Storage : -4°F to +176°F (-20°C to +80°C)
	Humidity	Operating/Storage: 20% to 90% (Non Condensing)

\*1 For 10GbE extension, use this product in combination with other IDK's SDVoE supported products.

\*2 HDR is supported if external EDID is selected while an HDR-supported sink device is connected for EDID setting or if copied EDID of an HDR-supported sink device is selected for EDID setting.

\*3 The maximum specified distances may not be achievable with some device combinations, cabling method, or other manufacturer's cable. For the same reasons, video signal disturbances or interruptions may occur, even if signals are within the specified distance (cable length) parameters.

The maximum cable length varies depending on the connected devices. The specifications have been qualified under following conditions:  
• 10GbE: When CAT6A (STP) cable is used.

## 12.9 FDX-SIV4S

Item		Description
Input		4 inputs (With loop-through output) Note: When the FDX-S is powered on, SDI input signals are output from SDI loop-through output connectors.
Video	SDI	3G-SDI/HD-SDI/SD-SDI NRZI/NRZ, 0.8 V <sub>p-p</sub> /75 Ω SMPTE 424M (3G-SDI)/SMPTE 292M (HD-SDI)/SMPTE 259M-C (SD-SDI)
	Format	480i / 576i / 720p / 1080i / 1080p 3G-SDI signals: Level A and Level B 720p: 23.98 Hz and 24 Hz are not supported.
Audio	Digital	LPCM up to 8 channels (Selecting 2 groups of audio groups 1 to 4) Sampling frequency: 48 kHz, Sample size: 16 bit to 24 bit Reference level: -20 dBFS, Max. input level: 0 dBFS
Connector		BNC
Cable		75 Ω coaxial cable for high frequency signal
Maximum transmission distances		With 1505A (BELDEN RG-59), SD-SDI: 1083 ft. (330 m)/HD-SDI: 656 ft. (200 m)/3G-SDI: 394 ft. (120 m) With 1694A (BELDEN RG-6), SD-SDI: 1312 ft. (400 m)/HD-SDI: 787 ft. (240 m)/3G-SDI: 459 ft. (140 m) * The maximum distances may be shorten depending on the quality of cable. Please make sure that the cable is long enough.
Function		3G-SDI/HD-SDI/SD-SDI input
General	Power consumption	About 30 Watts
	Weight	0.9 lbs. (0.4 kg)
	Temperature	Operating : 32°F to 104°F (0°C to +40°C) Storage : -4°F to +176°F (-20°C to +80°C)
	Humidity	Operating/Storage: 20% to 90% (Non Condensing)

## 12.10 FDX-SOV4UH

Item		Description
The number of outputs		4
Input	Video	Format 480i / 480p / 576i / 576p / 720p / 1080i / 1080p / 4K For 4K formats, 24 Hz/25 Hz/30 Hz/50 Hz (4:4:4)/60 Hz (4:4:4) are supported.
	Audio	Digital Multi-channel LPCM up to 8 channels Sampling frequency: 32 kHz to 192 kHz, Sample size: 16 bit to 24 bit Reference level: -20 dBFS, Max. input level: 0 dBFS
Output	Video	HDMI/DVI HDMI/DVI 1.0 TMDS single link, HDCP 1.4/2.2 TMDS clock: 25 MHz to 300 MHz, TMDS data rate: 0.75 Gbps to 18 Gbps 36 bit Deep Color, x.v.Color, 3D, HDR For 4K@50/59.94/60 RGB/YCbCr 4:4:4, 24 bit is supported. ARC/HEC/CEC are not supported.
		Format VGA to 4K (Dot clock: 25 MHz to 600 MHz) 480i / 480p / 576i / 576p / 720p / 1080i / 1080p / 4K For 4K formats, 24 Hz/25 Hz/30 Hz/50 Hz (4:4:4)/60 Hz (4:4:4) are supported.
	Audio	Digital Multi-channel LPCM up to 8 channels Sampling frequency: 32 kHz to 192 kHz, Sample size: 16 bit to 24 bit Reference level: -20 dBFS, Max. output level: 0 dBFS
Connector		Female HDMI Type A (19-pin)
Maximum transmission distances		98 ft. (30 m) (1080p@60), 39 ft. (12 m) (4K@60) (*1)
Functions		Anti-snow, Connection Reset (*2)
General	Power consumption	About 11 Watts
	Weight	0.7 lbs. (0.3 kg)
	Temperature	Operating : 32°F to 104°F (0°C to +40°C) Storage : -4°F to +176°F (-20°C to +80°C)
	Humidity	Operating/Storage: 20% to 90% (Non Condensing)

\*1 The maximum cable distance varies depending on the connected devices and was measured under following conditions:

- 1080p@60: When IDK's 24 AWG cable was used and signals of 1080p@60 24 bit/pixel (8 bit/component) was output.
- 4K@60 : When IDK's 18 Gbps supported cable was used and signals of 4K@60 24 bit/pixel (8 bit/component) was output.

The maximum cable distance depends on the connected devices. The distance may not be extended with some device combinations, cabling method, or other manufacturer's cable. Video may be disturbed or may not be output even if signals are within the range mentioned above.

\*2 For digital systems, some problems, such as an HDCP authentication error, can often be recovered by physically disconnecting and reconnecting the digital cables. However, the Connection Reset feature will fix these problems automatically without the need to physically plug and unplug the cables. It creates the same condition as if the cable were physically disconnected and reconnected. This feature only works for the FDX-S's output. If other devices are connected between the FDX-S's output and sink device, this feature may be invalid.

## 12.11 FDX-SOV4UT

Item		Description
The number of outputs		4
Input	Video	Format VGA to 4K (Dot clock: 25 MHz to 600 MHz) 480i / 480p / 576i / 576p / 720p / 1080i / 1080p / 4K For 4K formats, 24 Hz/25 Hz/30 Hz/50 Hz (4:4:4)/60 Hz (4:4:4) are supported.
	Audio	Digital Multi-channel LPCM up to 8 channels Sampling frequency: 32 kHz to 192 kHz, Sample size: 16 bit to 24 bit Reference level: -20 dBFS, Max. input level: 0 dBFS
Output	Video	HDBaseT HDCP 1.4/2.2 36 bit Deep Color, x.v.Color, 3D, HDR For WQHD, WQXGA, and 4K formats, 24 bit is supported. ARC/HEC/CEC are not supported. RS-232C/LAN
		Format VGA to 4K (Dot clock: 25 MHz to 600 MHz) For WQHD/WQXGA, only Reduced Blanking is supported. 480i / 480p / 576i / 576p / 720p / 1080i / 1080p / 4K For 4K formats, 24 Hz/25 Hz/30 Hz/50 Hz (4:2:0)/60 Hz (4:2:0) are supported.
	Audio	Digital Multi-channel LPCM up to 8 channels Sampling frequency: 32 kHz to 192 kHz, Sample size: 16 bit to 24 bit Reference level: -20 dBFS, Max. output level: 0 dBFS
Connector		RJ-45 (*1)
Cable		CAT.5E HDC, Cat5e UTP/STP, Cat6 UTP/STP (T568A/T568B straight-through)
Maximum transmission distances		328 ft. (100 m), 492 ft. (150 m) (Long reach mode is used) (*2)
Functions		Anti-snow, Connection Reset (*3)
General	Power consumption	About 18 Watts
	Weight	1.1 lbs. (0.5 kg)
	Temperature	Operating : 32°F to 104°F (0°C to +40°C) Storage : -4°F to +176°F (-20°C to +80°C)
	Humidity	Operating/Storage: 20% to 90% (Non Condensing)

\*1 RJ-45 (HDBaseT connector) is only for extending digital video and audio signals over a Cat5e/Cat6 cable. Use it with IDK's HDBaseT Products. Do not use for LAN devices.

\*2 The maximum transmission distance was obtained when IDK's CAT.5E HDC cable was used. The distance may not be extended with some device combinations, cabling method, or other manufacturer's cable. Video may be disturbed or may not be output even if signals are within the range mentioned above. The maximum transmission distance is the shorter distance of connected HDBaseT product or sink device's maximum transmission distance. Up to 492 ft. (150 m): 1080p (24 bit) in Long reach mode. For Long reach mode, use IDK's HDBaseT Products that supports 328 ft. (100 m) or longer.

\*3 For digital systems, some problems, such as an HDCP authentication error, can often be recovered by physically disconnecting and reconnecting the digital cables. However, the Connection Reset feature will fix these problems automatically without the need to physically plug and unplug the cables. It creates the same condition as if the cable were physically disconnected and reconnected. This feature only works for the FDX-S's output. If other devices are connected between the FDX-S's output and sink device, this feature may be invalid.

## 12.12 FDX-SOV4US

Item		Description
The number of output		4 (SINGLE LINK) 2 (DUAL LINK) 1 (QUAD LINK)
Input	Video	Format 720p to 4K (Dot clock: 74.25 MHz to 600 MHz) 720p / 1080i / 1080p / 4K For 4K formats, 24 Hz/25 Hz/30 Hz/50 Hz (4:4:4)/60 Hz (4:4:4) are supported.
	Audio	Digital Multi-channel LPCM up to 8 channels Sampling frequency: 48 kHz, Sample size: 16 bit to 24 bit Reference level: -20 dBFS, Max. input level: 0 dBFS
Output	Video	SDI 12G-SDI/6G-SDI/3G-SDI/HD-SDI NRZI/NRZ, 0.8 V[p-p]/75 Ω SMPTE ST-2082-1 (12G-SDI)/SMPTE ST-2081-1 (6G-SDI)/SMPTE 424M (3G-SDI)/SMPTE 292M (HD-SDI)
		Format 720p / 1080i / 1080p / 4K 3G-SDI signals : Only Level A Multiple link : 2SI (2 Sample Interleave) 720p : 23.98 Hz and 24 Hz are not supported.
	Audio	Digital LPCM up to 8 channels (Selecting 2 groups of audio groups1 to 4) Sampling frequency: 48 kHz, Sample size: 16 bit to 24 bit Reference level: -20 dBFS, Max. output level: 0 dBFS
Connector		BNC
Cable		75 Ω coaxial cable for high frequency signal
Maximum transmission distances (*1)		With 1505A (BELDEN RG-59), HD-SDI: 7.9 ft. (200 m) 3G-SDI: 5.1 ft. (130 m) With 1694A (BELDEN RG-6), HD-SDI: 820 ft. (250 m) 3G-SDI: 525 ft. (160 m) 6G-SDI: 262 ft. (80 m) 12G-SDI: 197 ft. (60 m)
Functions		12G-SDI/6G-SDI/3G-SDI/HD-SDI can be mixed (When gearbox function (*2) is disabled) Gearbox (DUAL LINK 3G: equivalent to 6G-SDI; DUAL LINK 6G 2SI: equivalent to 12G-SDI; QUAD LINK 3G LEVEL A 2SI: equivalent to 12G-SDI) Color format conversion: From RGB or YCbCr 4:4:4 to YCbCr 4:2:2
General	Power consumption	About 35 Watts
	Weight	1.1 lbs. (0.5 kg)
	Temperature	Operating : 32°F to 104°F (0°C to +40°C) Storage : -4°F to +176°F (-20°C to +80°C)
	Humidity	Operating/Storage: 20% to 90% (Non Condensing)

\*1 The maximum distances may be shorten depending on the quality of cable. Please make sure that the cable is long enough.  
The maximum distances are for when connected to FDX-SIV4US.

\*2 Can be enabled/disable separately for each board, and it converts signal from each input board to DUAL LINK 3G-SDI, DUAL LINK 6G-SDI, or QUAD LINK 3G-SDI.

## 12.13 FDX-SOV4UC

Item		Description
The number of outputs		4
Input	Video	Format VGA to 4K (Dot clock: 25 MHz to 600 MHz) 480i / 480p / 576i / 576p / 720p / 1080i / 1080p / 4K For 4K formats, 24 Hz/25 Hz/30 Hz/50 Hz (4:4:4)/60 Hz (4:4:4) are supported.
	Audio	Digital Multi-channel LPCM up to 8 channels Sampling frequency: 32 kHz to 192 kHz, Sample size: 16 bit to 24 bit Reference level: -20 dBFS, Max. input level: 0 dBFS
Output	Video	10GbE (*1) SDVoE, AES-128 36 bit Deep Color, HDR For 4K@50/59.94/60 RGB/YCbCr 4:4:4, 24 bit is supported. x.v.Color/3D/ARC/HEC/CEC are not supported. RS-232C/LAN
		Format VGA to 4K (Dot clock: 25 MHz to 600 MHz) For WQHD/WQXGA, only Reduced Blanking is supported. 480i / 480p / 576i / 576p / 720p / 1080i / 1080p / 4K For 4K formats, 24 Hz/25 Hz/30 Hz/50 Hz (4:4:4)/60 Hz (4:4:4) are supported.
	Audio	Digital Multi-channel LPCM up to 8 channels Sampling frequency: 32 kHz to 192 kHz, Sample size: 16 bit to 24 bit Reference level: -20 dBFS, Max. output level: 0 dBFS
Connector		RJ-45
Cable		CAT6A (STP)
Maximum transmission distance		328 ft. (100 m) (*2)
General	Power consumption	About 43 Watts
	Weight	1.3 lbs. (0.6 kg)
	Temperature	Operating : 32°F to 104°F (0°C to +40°C) Storage : -4°F to +176°F (-20°C to +80°C)
	Humidity	Operating/Storage: 20% to 90% (Non Condensing)

\*1 For 10GbE extension, use this product in combination with other IDK's SDVoE supported products.

\*2 The maximum specified distances may not be achievable with some device combinations, cabling method, or other manufacturer's cable. For the same reasons, video signal disturbances or interruptions may occur, even if signals are within the specified distance (cable length) parameters.

The maximum cable length varies depending on the connected devices. The specifications have been qualified under following conditions:  
 • 10GbE: When CAT6A (STP) cable is used.

## 12.14 FDX-SOV4UHS

Item			Description
The number of outputs			4
Input	Video	Format	VGA to 4K (Dot clock: 25 MHz to 600 MHz) 480p / 576p / 720p / 1080i / 1080p / 4K For 4K formats, 24 Hz / 25 Hz / 30 Hz / 50 Hz (4:4:4) / 60 Hz (4:4:4) are supported.
	Audio	Digital	Multi-channel LPCM up to 8 channels Sampling frequency: 32 kHz to 192 kHz, Sample size: 16 bit to 24 bit Reference level: -20 dBFS, Max. input level: 0 dBFS
Output	Video	HDMI/DVI	HDMI/DVI 1.0 TMDS single link, HDCP 1.4/2.2 TMDS clock: 25.175 MHz to 297 MHz, TMDS data rate: 0.755 Gbps to 17.82 Gbps 30 bit Deep Color For 4K@50/59.94 RGB/YCbCr 4:4:4, 24 bit is supported. x.v.Color/3D/HDR/ARC/HEC/CEC are not supported.
		Format	VGA / XGA / WXGA (1280x768) / WXGA (1280x800) / Quad-VGA / SXGA / WXGA (1360x768) / WXGA (1366x768) / SXGA+ / WXGA+ / WXGA++ / UXGA / WSXGA+ / VESAHD / WUXGA / QWXGA / WQHD / WQXGA For VESAHD / WUXGA / QWXGA / WQHD / WQXGA, only Reduced Blanking is supported. 480p / 576p / 720p / 1080i / 1080p / 4K (3840x2160) / 4K (4096x2160)
	Audio	Digital	Multi-channel LPCM up to 8 channels Sampling frequency: 32 kHz to 192 kHz, Sample size: 16 bit to 24 bit Reference level: -20 dBFS, Max. output level: 0 dBFS
Connector			Female HDMI Type A (19-pin)
Maximum transmission distances			98 ft. (30 m) (1080p@60), 39 ft. (12 m) (4K@60) (*1)
Functions	Scan Converter		Motion adaptive interlaced/progressive conversion, Aspect ratio control, Picture adjustment (brightness, contrast, image position, image size, etc.), Seamless Switching
	Others		Videowall output, Lip Sync (Max. 256 ms.), Anti-snow, Connection Reset (*2)
General	Power consumption		About 41 Watts
	Weight		1.8 lbs. (0.8 kg)
	Temperature		Operating : 32°F to 104°F (0°C to +40°C) Storage : -4°F to +176°F (-20°C to +80°C)
	Humidity		Operating/Storage: 20% to 90% (Non Condensing)

\*1 The maximum cable distance varies depending on the connected devices and was measured under following conditions:

- 1080p@60: When IDK's cable was used and signals of 1080p@60 24 bit/pixel (8 bit/component) was output.
- 4K@60 : When IDK's 18 Gbps supported cable was used and signals of 4K@60 24 bit/pixel (8 bit/component) was output.

The maximum cable distance depends on the connected devices. The distance may not be extended with some device combinations, cabling method, or other manufacturer's cable. Video may be disturbed or may not be output even if signals are within the range mentioned above.

\*2 For digital systems, some problems, such as an HDCP authentication error, can often be recovered by physically disconnecting and reconnecting the digital cables. However, the Connection Reset feature will fix these problems automatically without the need to physically plug and unplug the cables. It creates the same condition as if the cable were physically disconnected and reconnected. This feature only works for the FDX-S's output. If other devices are connected between the FDX-S's output and sink device, this feature may be invalid.

## 12.15 FDX-SOV2UHS

Item		Description
The number of outputs		2
Input	Video	Format VGA to 4K (Dot clock: 25 MHz to 600 MHz) 480i / 480p / 576i / 576p / 720p / 1080i / 1080p / 4K For 4K formats, 24 Hz/25 Hz/30 Hz/50 Hz (4:4:4)/60 Hz (4:4:4) are supported.
	Audio	Digital Multi-channel LPCM up to 8 channels Sampling frequency: 32 kHz to 192 kHz, Sample size: 16 bit to 24 bit Reference level: -20 dBFS, Max. input level: 0 dBFS
Output	Video	HDMI/DVI HDMI/DVI 1.0 TMDS single link, HDCP 1.4/2.2 TMDS clock: 25.175 MHz to 297 MHz, TMDS data rate: 0.755 Gbps to 17.82 Gbps 30 bit Deep Color For 4K@50/59.94 RGB/YCbCr 4:4:4, 24 bit is supported. x.v.Color/3D/HDR/ARC/HEC/CEC are not supported.
		Format VGA / XGA / WXGA (1280x768) / WXGA (1280x800) / Quad-VGA / SXGA / WXGA (1360x768) / WXGA (1366x768) / SXGA+ / WXGA+ / WXGA++ / UXGA / WSXGA+ / VESAHD / WUXGA / QWXGA / WQHD / WQXGA For VESAHD/WUXGA/QWXGA/WQHD/WQXGA, only Reduced Blanking is supported. 480p / 576p / 720p / 1080i / 1080p / 4K (3840x2160) / 4K (4096x2160)
	Audio	Digital Multi-channel LPCM up to 8 channels Sampling frequency: 32 kHz to 192 kHz, Sample size: 16 bit to 24 bit Reference level: -20 dBFS, Max. output level: 0 dBFS
Connector		Female HDMI Type A (19-pin)
Maximum transmission distances		98 ft. (30 m) (1080p@60), 39 ft. (12 m) (4K@60) (*1)
Functions	Scan Converter	Motion adaptive interlaced/progressive conversion, Aspect ratio control, Picture adjustment (brightness, contrast, image position, image size, etc.), Seamless Switching
	Others	Videowall output, Lip Sync (Max. 256 ms.), Anti-snow, Connection Reset (*2)
General	Power consumption	About 24 Watts
	Weight	1.3 lbs. (0.6 kg)
	Temperature	Operating : 32°F to 104°F (0°C to +40°C) Storage : -4°F to +176°F (-20°C to +80°C)
	Humidity	Operating/Storage: 20% to 90% (Non Condensing)

\*1 The maximum cable distance varies depending on the connected devices and was measured under following conditions:

- 1080p@60: When IDK's 24 AWG cable was used and signals of 1080p@60 24 bit/pixel (8 bit/component) was output.
- 4K@60 : When IDK's 18 Gbps supported cable was used and signals of 4K@60 24 bit/pixel (8 bit/component) was output.

The maximum cable distance depends on the connected devices. The distance may not be extended with some device combinations, cabling method, or other manufacturer's cable. Video may be disturbed or may not be output even if signals are within the range mentioned above.

\*2 For digital systems, some problems, such as an HDCP authentication error, can often be recovered by physically disconnecting and reconnecting the digital cables. However, the Connection Reset feature will fix these problems automatically without the need to physically plug and unplug the cables. It creates the same condition as if the cable were physically disconnected and reconnected. This feature only works for the FDX-S's output. If other devices are connected between the FDX-S's output and sink device, this feature may be invalid.

## 12.16 FDX-SOV1UHM

Item		Description
The number of output		1
Input	Video	Format VGA to 4K (Dot clock: 25 MHz to 600 MHz) 480p / 576p / 720p / 1080i / 1080p / 4K For 4K formats, 24 Hz/25 Hz/30 Hz/50 Hz (4:4:4)/60 Hz (4:4:4) are supported.
	Audio	Digital Multi-channel LPCM up to 8 channels Sampling frequency: 32 kHz to 192 kHz, Sample size: 16 bit to 24 bit Reference level: -20 dBFS, Max. input level: 0 dBFS
Output	Video	HDMI/DVI HDMI/DVI 1.0 TMDS single link, HDCP 1.4/2.2 TMDS clock: 25.175 MHz to 297 MHz, TMDS data rate: 0.755 Gbps to 17.82 Gbps 30 bit Deep Color For 4K@50/59.94 RGB/YCbCr 4:4:4, 24 bit is supported. x.v.Color/3D/HDR/ARC/HEC/CEC are not supported.
		Format VGA / XGA / WXGA (1280x768) / WXGA (1280x800) / Quad-VGA / SXGA / WXGA (1360x768) / WXGA (1366x768) / SXGA+ / WXGA+ / WXGA++ / UXGA / WSXGA+ / VESAHD / WUXGA / QWXGA / WQHD / WQXGA For VESAHD/WUXGA/QWXGA/WQHD/WQXGA, only Reduced Blanking is supported. 480p / 576p / 720p / 1080i / 1080p / 4K (3840x2160) / 4K (4096x2160)
	Audio	Digital Multi-channel LPCM up to 8 channels Sampling frequency: 32 kHz to 192 kHz, Sample size: 16 bit to 24 bit Reference level: -20 dBFS, Max. output level: 0 dBFS
Connector		Female HDMI Type A (19-pin)
Maximum transmission distances		98 ft. (30 m) (1080p@60), 39 ft. (12 m) (4K@60) (*1)
Functions	Scan Converter	Video combination, Motion adaptive interlaced/progressive conversion, Aspect ratio control, Picture adjustment (brightness, contrast, image position, image size, etc.), Seamless Switching
	Others	Window patten (10 patterns), Window combination settings (background color, display priority, display ON/OFF, position, size, title character, Window border), Videowall output, Lip Sync (Max. 256 ms.), Anti-snow, Connection Reset (*2)
General	Power consumption	About 24 Watts
	Weight	1.3 lbs. (0.6 kg)
	Temperature	Operating : 32°F to 104°F (0°C to +40°C) Storage : -4°F to +176°F (-20°C to +80°C)
	Humidity	Operating/Storage: 20% to 90% (Non Condensing)

\*1 The maximum cable distance varies depending on the connected devices and was measured under following conditions:

- 1080p@60: When IDK's 24 AWG cable was used and signals of 1080p@60 24 bit/pixel (8 bit/component) was output.
- 4K@60 : When IDK's 18 Gbps supported cable was used and signals of 4K@60 24 bit/pixel (8 bit/component) was output.

The maximum cable distance depends on the connected devices. The distance may not be extended with some device combinations, cabling method, or other manufacturer's cable. Video may be disturbed or may not be output even if signals are within the range mentioned above.

\*2 For digital systems, some problems, such as an HDCP authentication error, can often be recovered by physically disconnecting and reconnecting the digital cables. However, the Connection Reset feature will fix these problems automatically without the need to physically plug and unplug the cables. It creates the same condition as if the cable were physically disconnected and reconnected. This feature only works for the FDX-S's output. If other devices are connected between the FDX-S's output and sink device, this feature may be invalid.

## 12.17 FDX-SOV4HS

Item		Description
The number of outputs		4
Input	Video	Format VGA to QWXGA (Dot clock: 25 MHz to 165 MHz) For WUXGA/QWXGA, only Reduced Blanking is supported. 480i / 480p / 576i / 576p / 720p / 1080i / 1080p
	Audio	Digital Multi-channel LPCM up to 8 channels Sampling frequency: 32 kHz to 192 kHz, Sample size: 16 bit to 24 bit Reference level: -20 dBFS, Max. input level: 0 dBFS
Output	Video	HDMI/DVI HDMI/DVI 1.0 TMDS single link, HDCP 1.4 TMDS clock: 25.175 MHz to 202.5 MHz, TMDS data rate: 0.755 Gbps to 6.075 Gbps 30 bit Deep Color x.v.Color/3D/HDR/ARC/HEC/CEC are not supported. Built-in cable EQ
		Format VGA / XGA / WXGA (1280x768) / WXGA (1280x800) / Quad-VGA / SXGA / WXGA (1360x768) / WXGA (1366x768) / SXGA+ / WXGA+ / WXGA++ / UXGA / WSXGA+ / VESAHD / WUXGA / QWXGA For VESAHD/WUXGA/QWXGA, only Reduced Blanking is supported. 480p / 576p / 720p / 1080i / 1080p
	Audio	Digital Multi-channel LPCM up to 8 channels Sampling frequency: 32 kHz to 192 kHz, Sample size: 16 bit to 24 bit Reference level: -20 dBFS, Max. output level: 0 dBFS
Connector		Female HDMI Type A (19-pin)
Maximum transmission distances		131 ft. (40 m) (*1)
Functions	Scan Converter	Motion adaptive interlaced/progressive conversion, Aspect ratio control, Picture adjustment (brightness, contrast, image position, image size, etc.), Seamless Switching
	Others	Widewall output, Lip Sync (Max. 256 ms.), Anti-snow, Connection Reset (*2)
General	Power consumption	About 33 Watts
	Weight	1.8 lbs. (0.8 kg)
	Temperature	Operating : 32°F to 104°F (0°C to +40°C) Storage : -4°F to +176°F (-20°C to +80°C)
	Humidity	Operating/Storage: 20% to 90% (Non Condensing)

\*1 The maximum cable distance varies depending on the connected devices and was measured under following conditions:  
 • 1080p@60: When IDK's 24 AWG cable was used and signals of 1080p@60 24 bit/pixel (8 bit/component) was input or output.  
 The maximum cable distance depends on the connected devices. The distance may not be extended with some device combinations, cabling method, or other manufacturer's cable. Video may be disturbed or may not be output even if signals are within the range mentioned above.

\*2 For digital systems, some problems, such as an HDCP authentication error, can often be recovered by physically disconnecting and reconnecting the digital cables. However, the Connection Reset feature will fix these problems automatically without the need to physically plug and unplug the cables. It creates the same condition as if the cable were physically disconnected and reconnected. This feature only works for the FDX-S's output. If other devices are connected between the FDX-S's output and sink device, this feature may be invalid.

## 12.18 FDX-SOV4TS

Item		Description
The number of outputs		4
Input	Video	Format VGA to QWXGA (Dot clock: 25 MHz to 165 MHz) For WUXGA/QWXGA, only Reduced Blanking is supported. 480i / 480p / 576i / 576p / 720p / 1080i / 1080p
	Audio	Digital Multi-channel LPCM up to 8 channels Sampling frequency: 32 kHz to 192 kHz, Sample size: 16 bit to 24 bit Reference level: -20 dBFS, Max. input level: 0 dBFS
Output	Video	HDBaseT HDCP 1.4 30 bit Deep Color x.v.Color/3D/HDR/ARC/HEC/CEC are not supported. RS-232C/LAN
		Format VGA / XGA / WXGA (1280x768) / WXGA (1280x800) / Quad-VGA / SXGA / WXGA (1360x768) / WXGA (1366x768) / SXGA+ / WXGA+ / WXGA++ / UXGA / WSXGA+ / VESAHD / WUXGA / QWXGA For VESAHD/WUXGA/QWXGA, only Reduced Blanking is supported. 480p / 576p / 720p / 1080i / 1080p
	Audio	Digital Multi-channel LPCM up to 8 channels Sampling frequency: 32 kHz to 192 kHz, Sample size: 16 bit to 24 bit Reference level: -20 dBFS, Max. output level: 0 dBFS
Connector		RJ-45 (*1)
Cable		CAT.5E HDC, Cat5e UTP/STP, Cat6 UTP/STP (T568A/T568B straight-through)
Maximum transmission distances		328 ft. (100 m), 492 ft. (150 m) (Long reach mode is used) (*2)
Functions	Scan Converter	Motion adaptive interlaced/progressive conversion, Aspect ratio control, Picture adjustment (brightness, contrast, image position, image size, etc.), Seamless Switching
	Others	Videowall output, Lip Sync (Max. 256 ms.), Anti-snow, Connection Reset (*3)
General	Power consumption	About 40 Watts
	Weight	1.8 lbs.(0.8 kg)
	Temperature	Operating : 32°F to 104°F (0°C to +40°C) Storage : -4°F to +176°F (-20°C to +80°C)
	Humidity	Operating/Storage: 20% to 90% (Non Condensing)

\*1 RJ-45 (HDBaseT connector) is only for extending digital video and audio signals over a Cat5e/Cat6 cable. Use it with IDK's HDBaseT Products. Do not use for LAN devices.

\*2 The maximum transmission distance was obtained when IDK's CAT.5E HDC cable was used. The distance may not be extended with some device combinations, cabling method, or other manufacturer's cable. Video may be disturbed or may not be output even if signals are within the range mentioned above. The maximum transmission distance is the shorter distance of connected HDBaseT product or sink device's maximum transmission distance. Up to 492 ft. (150 m): 1080p (24 bit) in Long reach mode. For Long reach mode, use IDK's HDBaseT Products that supports 328 ft. (100 m) or longer.

\*3 For digital systems, some problems, such as an HDCP authentication error, can often be recovered by physically disconnecting and reconnecting the digital cables. However, the Connection Reset feature will fix these problems automatically without the need to physically plug and unplug the cables. It creates the same condition as if the cable were physically disconnected and reconnected. This feature only works for the FDX-S's output. If other devices are connected between the FDX-S's output and sink device, this feature may be invalid.

## 12.19 FDX-SAB4A

Item		Description
Input	Analog audio	4 inputs Unbalanced Stereo LR Input impedance: 24 kΩ Reference level: -10dBu, Max. input level: +10dBu
Output	Analog audio	4 outputs Balanced/Unbalanced Stereo LR Output impedance: 100 Ω balanced/50 Ω unbalanced Reference level: -10dBu, Max. output level: +10dBu
Connector		Input : 4 captive screw (3-pin) Output : 4 captive screw (5-pin)
Function		Lip Sync (Max. 256 ms.)
General	Power consumption	About 9 Watts
	Weight	1.3 lbs. (0.6 kg)
	Temperature	Operating : 32°F to 104°F (0°C to +40°C) Storage : -4°F to +176°F (-20°C to +80°C)
	Humidity	Operating/Storage: 20% to 90% (Non Condensing)

## 12.20 FDX-SOA12A

Item		Description
Output	Analog audio	12 outputs Unbalanced Stereo LR Output impedance: 50 Ω Reference level: -10dBu, Max. output level: +10dBu
Connector		Captive screw (3-pin)
Function		Lip Sync (Max. 256 ms.)
General	Power consumption	About 18 Watts
	Weight	1.3 lbs. (0.6 kg)
	Temperature	Operating : 32°F to 104°F (0°C to +40°C) Storage : -4°F to +176°F (-20°C to +80°C)
	Humidity	Operating/Storage: 20% to 90% (Non Condensing)

## 12.21 FDX-SAB64D

Item		Description
Input	Dante network audio	1 input Format: Dante protocol Sampling frequency: 48 kHz, Sample size: 24 bit Maximum audio input channel: 64 channels (32 stereo audio channels)
Output	Dante network audio	1 output Format: Dante protocol Sampling frequency: 48 kHz, Sample size: 24 bit Maximum audio output channel: 64 channels (32 stereo audio channels)
Connector		2 RJ-45 (Primary/Secondary) (*1)
General	Power consumption	About 11 Watts
	Weight	1.3 lbs. (0.6 kg)
	Temperature	Operating : 32°F to 104°F (0°C to +40°C) Storage : -4°F to +176°F (-20°C to +80°C)
	Humidity	Operating/Storage: 20% to 90% (Non Condensing)

\*1 These RJ-45 connectors are only for Dante format.

## 12.22 FDX-SRP08

---

Item	Description
Power	100 - 240 VAC $\pm$ 10%, 50 Hz/60 Hz $\pm$ 3 Hz, 2 power connectors
Weight	4 lbs. (1.8 kg)
Temperature	Operating : 32°F to 104°F (0°C to +40°C) Storage : -4°F to +176°F (-20°C to +80°C)
Humidity	Operating/Storage: 20% to 90% (Non Condensing)

## 12.23 FDX-SRP16

---

Item	Description
Power	100 - 240 VAC $\pm$ 10%, 50 Hz/60 Hz $\pm$ 3 Hz, 2 power connectors
Weight	6 lbs. (2.7 kg)
Temperature	Operating : 32°F to 104°F (0°C to +40°C) Storage : -4°F to +176°F (-20°C to +80°C)
Humidity	Operating/Storage: 20% to 90% (Non Condensing)

## 12.24 FDX-SRP32

---

Item	Description
Power	100 - 240 VAC $\pm$ 10%, 50 Hz/60 Hz $\pm$ 3 Hz, 2 power connectors
Weight	10.6 lbs. (4.8 kg)
Temperature	Operating : 32°F to 104°F (0°C to +40°C) Storage : -4°F to +176°F (-20°C to +80°C)
Humidity	Operating/Storage: 20% to 90% (Non Condensing)

## 12.25 FDX-SRP64

---

Item	Description
Power	100 - 240 VAC $\pm$ 10%, 50 Hz/60 Hz $\pm$ 3 Hz, 2 power connectors
Weight	23.4 lbs. (10.6 kg)
Temperature	Operating : 32°F to 104°F (0°C to +40°C) Storage : -4°F to +176°F (-20°C to +80°C)
Humidity	Operating/Storage: 20% to 90% (Non Condensing)

## 13 Troubleshooting

This chapter provides recommendations in case difficulties are encountered during FDX-S setup and operation.

In case the FDX-S does not work correctly, please check the following items first.

- Are the FDX-S and all devices connected to power and powered on?
- Are signal cables connected correctly?
- Are there any loose or partially mated connections?
- Are the interconnecting cables specified correctly to support adequate bandwidth?
- For 4K format, is an 18 Gbps high-speed cable used?
- Are specifications of connected devices matched to each other?
- Are configuration settings for the connected devices correct?
- Is there any nearby equipment that may cause electrical noise/RF interference?

If the problem persists, review the following section for guidelines and recommendations. Refer to the manuals of connected devices as well, since they may possibly be the cause of the problem.

Problem	Cause/Check item/Solution	Page
• Video output		
Video is not being output.	[1] If output board other than scan converter output board is installed, check if the EDID resolution setting of this device is set to the input resolution supported by the sink device? If a scan converter output board is installed, check if the output resolution supported by the sink device is set. <ul style="list-style-type: none"> <li>• Vertical sync frequency: For TV output resolutions (480i to 4K), video of 59.94 Hz or 60Hz may not be output.</li> <li>• PC output resolutions (VGA to 4K) may not be output to LCD TVs and plasma TVs.</li> </ul>	133  87
	[2] Are signals output from the source device? If the input resolution is displayed in "INPUT STATUS 1", check [3] to [8]; if "No Signal" is displayed, check [9] to [11].	168
	[3] Check the presence of HDCP. Check if the input signal is protected by HDCP in "INPUT STATUS 2". H, D : Signal protected by HDCP 1.4. h, d, s : The signal is not protected.  If signal is protected by HDCP, check HDCP and stream types as well. T : HDCP 2.2 stream type 1 t : HDCP 2.2 stream type 0 No value : HDCP 1.4 For multi window, check input signals of each window.	168

Problem	Cause/Check item/Solution	Page
● Video output (Cont'd)		
Video is not being output.	[4] Check if the sink device support HDCP in “SINK DEVICE EDID 2”. If it does not match the result of [3], video may not be displayed. Check the every sink device connector. [OFF] or [- - -]: Sink device’s resolution may not be supported. Check the specification of the sink device. Some HDMI/DVI devices check if the connected device is HDCP compliant and determines whether to output HDCP signal or not. Since the FDX-S is HDCP compliant, the FDX-S may not output video if connected to a sink device that does not support HDCP. In such a case, disable the HDCP input from the source device.	168           115
	[5] If output board other than scan converter output board is installed, check if the resolution supported by the sink device is input? Check the resolution and video frequency in “[INPUT STATUS 1”. If a scan converter output board is installed, check if the output resolution supported by the sink device is set. Sink device’s resolution may not be supported. Check the specification of the sink device.	173    87
	[6] For 4K format, does the sink device support SCDC? Check if the sink device supports SCDC in “[SINK DEVICE EDID 3]”. • ON : SCDC supported. • -- : SCDC is not supported; vide is not displayed.	173
	[7] Change the setting of Hot plug ignoring duration.	108
	[8] If a long cable is connected for input or output when 4K@60 HDMI/DVI digital I/O board is installed, replace it with a 16 ft. (5 m) or shorter cable. Even though a 16 ft. (5 m) or longer cable can be connected for digital I/O of the FDX-S, HDCP authorization or EDID acquisition may fail depending on the cable quality and the connected device.	26
	[9] The time setting for monitoring no-signal input may be too short.	114
	[10] Check the video output setting of the source device.	—
	[11] If Long reach mode of 4K@60 HDBaseT I/O board is set to enabled, only up to 1080p (24 bit) or 148 MHz can be transmitted.	105 116
	[12] For SDI input or SDI output, does the gearbox mode support the input or selected signal? The receiver may not support the output format; check the specifications of the receiver.	109 110 117



Problem	Cause/Check item/Solution	Page
● Video output (Cont'd)		
The left, right, top and bottom sides are cut off.	Some sink devices overscan input video, and the video may be cut out. Check the display setting of the sink device. If a scan converter output board is installed, check image position and image size settings.	—
Video is reduced vertically or horizontally.	Some sink devices display input video with full screen mode, and the aspect ratio cannot be kept. Check the display setting of the sink device. With some resolutions, full-screen display cannot be avoided. If output board other than scan converter output board is installed, change the output resolution of the source device. If a scan converter output board is installed, check the output resolution setting.	—
Black is displayed at top, bottom, right and left on PC video or only part of the PC video is displayed, and the rest can be revealed by scrolling with the mouse.	If the PC has the Panel Fit function, select [Scale Full Screen]. If the resolution that is set for the PC and the resolution that is actually output from the PC are not matched, those problems may occur. Check the resolution of the PC and the EDID resolution setting.	133
PC's dual monitor cannot be set or the setting is canceled.	If the monitoring function for no-signal input is enabled, the dual monitor function of your PC may not work correctly. In this case, disable the monitoring function.	114
Video is displayed in purple or green.	Some sink devices do not find the color space of the input video correctly, and the video may be displayed in purple or green. Set the correct color space in the output mode to solve this problem.	104
Brightness is improper.	If a scan converter output board is installed, you can adjust the output and input brightness settings.	124 125
	Is HDR signal used? If HDR-non-supported sink device tries to receive HDR signal, the video is displayed with improper brightness. Check if the sink device supports HDR in [SINK DEVICE EDID 3]. Some I/O boards do not support HDR. If the source device determines HDR with EDID and outputs HDR signal, check the EDID setting of the FDX-S.	168  187 to 197 131

Problem	Cause/Check item/Solution	Page
● Audio output		
Audio is not being output.	Is audio embedded to input signal?	168
	Check input audio signal, sampling frequency, and other settings in [INPUT AUDIO STATUS]. Also, check embedded audio settings.	128
	Ensure that audio output is turned on.	127
	If there are multiple output connectors in the source device, check the audio output setting of the source device.	—
	Ensure that the input audio format is supported by the connected sink device. Typically, LCD monitors may not output 88.2 kHz or higher sampling frequency of LPCM and compressed audio (such as Dolby Digital, DTS, and other format). In order to play a Blu-ray disc having compressed audio, check the audio output setting of the source device. The source device's audio signal characteristics can be managed by the HDC's EDID configuration settings.	137 to 139
	Ensure that DVI signal is not being output from the source device.	173
	Ensure that the output mode is not set to DVI output.	104
	If the EDID of the connected sink device cannot be obtained for some reason, the FDX-S cannot determine the sink type. As a result, audio may not be output. In such case, set " <b>10.5.10 Sink device EDID check</b> " to "ALWAYS1" or "ALWAYS2".	168 107
Even though multi-channel audio is played, only 2-channel audio is output	For multi-channel, change the EDID setting which is set to 2-channel audio by default. If the problem still cannot be solved, check if multi-channel audio is output from the source device again.	140
Audio that does not match output video.	Check if embedded audio is set to audio board input audio? If so, change the setting.	128
Audio is not output from audio board.	If compressed audio (Dolby Digital, DTS, and the like) is input, analog audio or Dante is not output. You can check the input audio type in input signal status.	129 168
Audio with incorrect setting is output from audio board.	Video output channel is selected to embedded audio, check the embedded audio setting. Note that digital audio of selected video input channel is output. (Audio that is embedded to video output signal is not output from the audio board.)	128 129
	For Dante output, check the setting of DanteController. Note that channel number which is displayed on DanteController does not match the Dante I/O number of the FDX-S menu.	74

Problem	Cause/Check item/Solution	Page
● Audio output (Cont'd)		
Compressed audio (such as Dolby Digital, DTS) is not output from the source device.	Compressed audio input is set to OFF (EDID settings) by factory default. If using compressed audio, change the EDID setting.	137 to 139
	Check the audio output settings of the source device.	—
● Button operation		
Buttons do not operate.	Ensure that buttons are not locked.	55
	When the FDX-S is powered on, it takes about 15 seconds to start up. During the start-up process, all buttons are disabled.	—
● Communication command control		
Control commands cannot be issued from PC to the FDX-S.	Are the following items set correctly? For RS-232C : Baud rate and data word length For LAN: IP address and subnet mask	141 to 142
	When the FDX-S is powered on, it takes about 15 seconds to start up. During the start-up process, communication command control is disabled.	—
● WEB browser control		
WEB browser cannot be issued from PC to the FDX-S.	Is the connection setting of the TCP port valid for the web browser?	142
	Immediately after the FDX-S is powered on, control from the WEB browser cannot be received.	47
	Ensure that the WEB browser JavaScript is effective.	—

If additional assistance is required, please perform the following tests and then contact us.

No.	Checking items	Result
1	The problem occurs at all connectors?	Yes or No
2	Connect the devices using genuine cables without connecting the FDX-S. The problem still cannot be solved? Please contact us for assistance.	Yes or No

---

## User Guide of FDX-S Series

Ver.4.15.0

Issued on: 5 January 2025

---



### Headquarters

IDK Corporation  
7-9-1 Chuo, Yamato-shi, Kanagawa-pref.  
242-0021 JAPAN  
TEL: +81-46-200-0764 FAX: +81-46-200-0765

Email: [idk\\_eng@idk.co.jp](mailto:idk_eng@idk.co.jp)

URL: [www.idkav.com](http://www.idkav.com)

### USA

IDK America Inc.  
72 Grays Bridge Road Suite 1-C, Brookfield, CT 06804  
TEL: +1-203-204-2445

Email: [sales@idkav.com](mailto:sales@idkav.com)

URL: [www.idkav.com](http://www.idkav.com)

### Europe

IDK Europe GmbH  
Lise-Meitner-Str. 6, D-40878 Ratingen  
TEL: +49-2102-578-301-0

Email: [info@idkav.eu](mailto:info@idkav.eu)

URL: [www.idkav.com](http://www.idkav.com)



### Product information Support

Arvanics Corporation  
7-9-1 Chuo, Yamato-shi, Kanagawa-pref.  
242-0021 JAPAN  
TEL: +81-46-259-6920 FAX: +81-46-259-6930

Email: [info@arvanics.com](mailto:info@arvanics.com)

URL: [www.arvanics.com](http://www.arvanics.com)

Information in this document is subject to change without notice.

©2020 IDK Corporation, all rights reserved. All trademarks mentioned are the property of their respective owners.