

## HDMI Distribution Amplifier

# VAC-S Series

VAC-S12U/VAC-S14U/VAC-S16U/VAC-S18U

<User Guide>

Ver.2.0.0

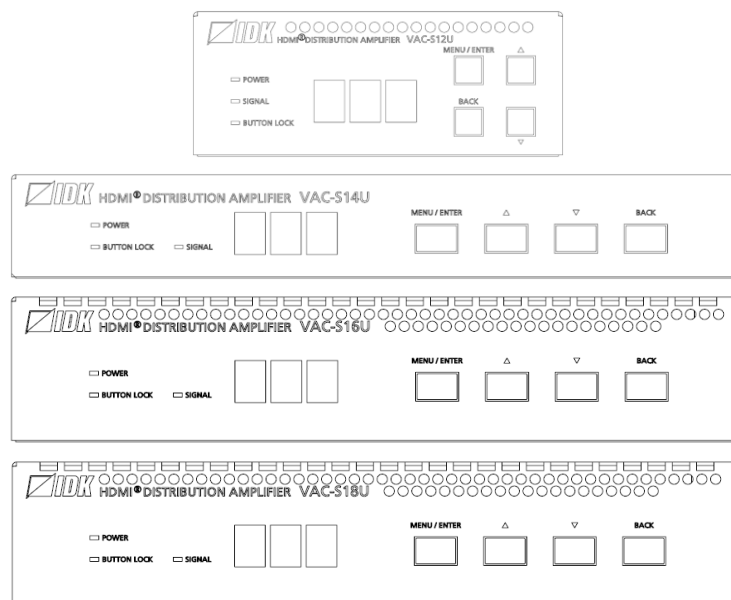

- Thank you for choosing our product.
- To ensure the best performance of this product, please read this user guide fully and carefully before using it and keep this manual together with the product for future reference as needed.

## **Trademarks**

- HDBaseT™ and the HDBaseT Alliance Logo are trademarks of the HDBaseT Alliance.
- The terms HDMI and HDMI High-Definition Multimedia Interface, and the HDMI Logo are trademarks or registered trademarks of HDMI Licensing Administrator, Inc. in the United States and other countries.
- SDVoE™ and SDVoE logo are trademarks of SDVoE Alliance.
- All other company and product names mentioned in this document are either registered trademarks or trademarks of their respective owners. In this document, the “®” or “™” marks may not be specified.
- ©2021 IDK Corporation, all rights reserved.

# Before reading this manual

- All rights reserved.
- Some information contained in this user guide such as exact product appearance, diagrams, menu operations, and so on may differ depending on the product version.
- This user guide is subject to change without notice. You can download the latest version from IDK's website at: [www.idkav.com](http://www.idkav.com)

The reference manual consists of the following two volumes:

- User guide (this document)
- Command guide: Please download the command guide from the website above.

**FCC STATEMENT**

**Note:** This equipment has been tested and found to comply with the limits for a Class A digital device, pursuant to part 15 of the FCC Rules. These limits are designed to provide reasonable protection against harmful interference when the equipment is operated in a commercial environment. This equipment generates, uses, and can radiate radio frequency energy and, if not installed and used in accordance with the instruction manual, may cause harmful interference to radio communications. Operation of this equipment in a residential area is likely to cause harmful interference, in which case the user will be required to correct the interference at his own expense.

(Class A)

**Supplier's Declaration of Conformity  
47 CFR § 2.1077 Compliance Information**

**Unique Identifier**

Type of Equipment: HDMI DISTRIBUTION AMPLIFIER  
Model Name: VAC-S12U, VAC-S14U, VAC-S16U, VAC-S18U

**Responsible Party – U.S. Contact Information**

Company Name: IDK America Inc.  
Address: 72 Grays Bridge Road Suite 1-C, Brookfield, CT 06804  
Telephone number: +1-203-204-2445  
URL: www.idkav.com

**FCC Compliance Statement**

This device complies with Part 15 of the FCC Rules. Operation is subject to the following two conditions: (1) This device may not cause harmful interference, and (2) this device must accept any interference received, including interference that may cause undesired operation.

(FCC SDoC)

**CE MARKING**

This equipment complies with the essential requirements of the relevant European health, safety and environmental protection legislation.

**WEEE MARKING**





Waste Electrical and Electronic Equipment (WEEE), Directive 2002/96/EC  
(This directive is only valid in the EU.)







This equipment complies with the WEEE Directive (2002/96/EC) marking requirement.  
The left marking indicates that you must not discard this electrical/electronic equipment in domestic household waste.

# Safety Instructions

Read all safety and operating instructions before using this product. Follow instructions and heed warnings/cautions.

Instructions and warnings/cautions for all products are provided. Some of them may not be applicable to your product.

	<h2 style="margin: 0;">Warning</h2>	Indicates the presence of a hazard that may result in death or serious personal injury if the warning is ignored or the product is handled incorrectly.
	<h2 style="margin: 0;">Caution</h2>	Indicates the presence of a hazard that may cause minor personal injury or property damage if the caution is ignored or the product is handled incorrectly.

Symbol	Description	Example
 Caution	This symbol is intended to alert the user. (Warning and caution)	 Hot surfaces Caution
 Prohibited	This symbol is intended to prohibit the user from specified actions.	 Do not disassemble
 Instruction	This symbol is intended to instruct the user.	 Unplug

## Warning

### For lifting heavy products:

 Instruction	<ul style="list-style-type: none"> <li>● <b>Lifting must be done by two or more personnel.</b></li> </ul> <p>To avoid injury: When lifting the product, bend your knees, keep your back straight and get close to it with two or more persons.</p>
--	--





### For installing and connecting products:

 Prohibited	<ul style="list-style-type: none"> <li>● <b>Do not place the product in unstable place.</b></li> </ul> <p>Install the product in a horizontal and stable place, as this may fall or tip over and cause injury.</p> <ul style="list-style-type: none"> <li>● <b>Secure the product if installing in the locations with vibration.</b></li> </ul> <p>Vibration may move or tip over the product unexpectedly, resulting in injury.</p>
---	--

# Warning

 <b>Instruction</b>	<ul style="list-style-type: none"> <li>● <b>Installation work must be performed by professionals.</b> The product is intended to be installed by skilled technicians. For installation, please contact a system integrator or IDK. Improper installation may lead to the risk of fire, electric shock, injury, or property damage.</li> <li>● <b>Insert the power plug into an outlet that is unobstructed.</b> Unobstructed access to the plug enables unplugging the product in case of any extraordinary failure, abnormal situation or for easy disconnection during extended periods of non-use.</li> <li>● <b>Insert the power plug into an appropriate outlet completely.</b> If the plug is partially inserted, arcing may cause the connection to overheat, increasing the risk of electric shock or fire. Do not use a damaged plug or connect to a loose outlet.</li> <li>● <b>Unplug the product from an AC power source during installation or service.</b> When connecting peripheral devices to this product, unplug all involved devices from outlets. Ground potential differences may cause fire or other difficulties.</li> <li>● <b>The product must be electrically earthed/grounded.</b> To reduce the risk of electric shock, ensure the product is connected to a mains socket outlet with a protective earthing connection.</li> <li>● <b>For powering/powered functions, compatible cables must be used.</b> Otherwise, it may cause problems or a fire.</li> </ul>
---	---

**For operating products:**



 <b>Prohibited</b>	<ul style="list-style-type: none"> <li>● <b>Keep out any foreign objects.</b> To avoid fire or electric shock, do not permit foreign objects, such as metal and paper, to enter the product from vent holes or other apertures.</li> <li>● <b>For power cables/plugs, AC adapters, and cables for powering/powered functions,</b> <ul style="list-style-type: none"> <li>• Do not scratch, heat, or modify, including splicing or lengthening them.</li> <li>• Do not pull, place heavy objects on them, or pinch them.</li> <li>• Do not bend, twist, tie or clamp them together forcefully.</li> </ul> </li> </ul> <p>Misuse of the power cable and plug may cause fire or electric shock. If power cables/plugs become damaged, contact your IDK representative.</p>
 <b>Do not disassemble</b>	<ul style="list-style-type: none"> <li>● <b>Do not repair, modify or disassemble.</b> Since the product includes circuitry that uses potentially lethal, high voltage levels, disassembly by unauthorized personnel may lead to the risk of fire or electric shock. For internal inspection or repair, contact your IDK representative.</li> </ul>
 <b>Do not touch</b>	<ul style="list-style-type: none"> <li>● <b>Do not touch the product and connected cables during electric storms.</b> Contact may cause electric shock.</li> </ul>
 <b>Instruction</b>	<ul style="list-style-type: none"> <li>● <b>Clean the power plug regularly.</b> If the plug is covered in dust, it may increase the risk of fire.</li> </ul>

**If the following problem occurs:**





 <b>Unplug</b>	<ul style="list-style-type: none"> <li>● <b>Unplug immediately if the product smokes, makes unusual noise, or produces a burning odor.</b></li> <li>● <b>Unplug immediately if the product is damaged by falling or having been dropped.</b></li> <li>● <b>Unplug immediately if water or other objects are directed inside.</b></li> </ul> <p>If you continue to use the product under these conditions, it may increase the risk of electric shock or fire. For maintenance and repair, contact your IDK representative.</p>
--	--

# **Caution**

**For installing and connecting products:**

 <b>Prohibited</b>	<ul style="list-style-type: none"> <li>● <b>Do not place the product in a location where it will be subjected to high temperatures.</b> If the product is subjected to direct sunlight or high temperatures while under operation, it may affect the product's performance and reliability and may increase the risk of fire.</li> <li>● <b>Do not store or operate the product in dusty, oil smoke filled, or humid place.</b> Placing the product in such environment may increase the risk of fire or electric shock.</li> <li>● <b>Do not block the vent holes.</b> If ventilation slots are blocked, it may cause the product to overheat, affecting performance and reliability and may increase the risk of fire.</li> <li>● <b>Do not place or stack heavy items on the product.</b> Failure to observe this precaution may result in damage to the product itself as well as other property and may lead to the risk of personal injury.</li> <li>● <b>Do not exceed ratings of outlet and wiring devices.</b> Exceeding the rating of an outlet may increase the risk of fire and electric shock.</li> </ul>
 <b>No wet hands</b>	<ul style="list-style-type: none"> <li>● <b>Do not handle power plug with wet hands.</b> Failure to observe this precaution may increase the risk of electric shock.</li> </ul>
 <b>Instruction</b>	<ul style="list-style-type: none"> <li>● <b>Use and store the product within the specified temperature/humidity range.</b> If the product is used outside the specified range of temperature and humidity continuously, it may increase the risk of fire or electric shock.</li> <li>● <b>Do not place the product at elevations of 1.24 mi. (2,000 m) or higher above sea level.</b> Failure to do so may shorten the life of the internal parts and result in malfunctions.</li> <li>● <b>When mounting the product into the rack, provide sufficient cooling space.</b> Mount the product in a rack meeting EIA standards, and maintain spaces above and below for air circulation. For your safety as required, attach an L-shaped bracket in addition to the panel mount bracket kit to improve mechanical stability.</li> <li>● <b>Never insert screws without the rubber feet into the threaded holes on the bottom of the product.</b> Never insert screws alone into the threaded holes on the bottom of the product. Doing so may lead to damage when the screws contact electric circuitry or components inside the product. Reinstall the originally supplied rubber feet using the originally supplied screws only.</li> </ul>

**For operating products:**

 <p><b>Hot surfaces Caution</b></p>	<p><b>For products with the hot surfaces caution label only:</b></p> <ul style="list-style-type: none"> <li>● <b>Do not touch the product's hot surface.</b></li> </ul> <p>If the product is installed without enough space, it may cause malfunction of other products. If you touch product's hot surface, it may cause burns.</p>
 <p><b>Prohibited</b></p>	<ul style="list-style-type: none"> <li>● <b>Use only the supplied power cable and AC adapter.</b></li> <li>● <b>Do not use the supplied power cable and AC adapter with other products.</b></li> </ul> <p>If non-compliant adapter or power cables are used, it may increase the risk of fire or electric shock.</p>
 <p><b>Unplug</b></p>	<ul style="list-style-type: none"> <li>● <b>If the product won't be used for an extended period of time, unplug it.</b></li> </ul> <p>Failure to observe this precaution may increase the risk of fire.</p> <ul style="list-style-type: none"> <li>● <b>Unplug the product before cleaning.</b></li> </ul> <p>To prevent electric shock.</p>
 <p><b>Instruction</b></p>	<ul style="list-style-type: none"> <li>● <b>Do not prevent heat release.</b></li> </ul> <p>If cooling fan stops, power off the product and contact IDK. Failure to do so may raise internal temperature and increase the risk of malfunction, fire, or electric shock.</p> <ul style="list-style-type: none"> <li>● <b>Keep vents clear of dust.</b></li> </ul> <p>If the vent holes near the cooling fan or near the fan are covered with dust, internal temperatures increase and may increase the risk of malfunction. Clean the vent holes and near the fan as needed. If dust accumulates inside of the product, it may increase the risk of fire or electric shock. Periodic internal cleaning, especially before humid rainy season, is recommended. For internal cleaning, contact your IDK representative.</p>

## Table of Contents

1	Included items.....	11
2	About VAC-S.....	12
3	Features.....	13
3.1	Down conversion.....	14
3.2	Output mode for when signal is input.....	14
3.3	LAN.....	15
3.4	Control from Web browser.....	15
4	Panels.....	16
4.1	Front panel.....	16
4.2	Rear panel.....	17
5	System Configuration Example.....	18
6	Precautions.....	19
6.1	Installation.....	19
6.2	Connection details.....	19
6.2.1	HDMI cable.....	20
6.2.2	Cable Lacing Bracket.....	20
6.2.3	Connecting audio cable.....	21
6.3	Connecting LAN cable.....	21
6.4	DIN plug AC adapter with locking mechanism.....	22
7	Basic Operation.....	24
7.1	Menu operation.....	24
7.2	WEB operation.....	25
7.2.1	WEB browser.....	26
7.3	Front panel security lockout.....	27
7.4	Unsolicited status notification.....	27
7.5	Initialization.....	28
8	Menu.....	29
8.1	Front menu.....	30
8.2	WEB browser menu.....	32
8.3	EDID.....	34
8.3.1	Copying EDID.....	35
8.3.2	Resolution.....	36
8.3.3	External EDID.....	39
8.3.4	Selecting copied EDID.....	40
8.3.5	Deep Color.....	41
8.3.6	LPCM audio.....	41
8.3.7	AC-3 Dolby Digital audio.....	42
8.3.8	AAC audio.....	42
8.3.9	Dolby Digital Plus audio.....	43
8.3.10	DTS audio.....	43
8.3.11	DTS-HD audio.....	44
8.3.12	Dolby TrueHD audio.....	44
8.3.13	Speaker configuration.....	45
8.3.14	Copying CEC physical address.....	46
8.3.15	Frame rate.....	46
8.4	Audio.....	47
8.4.1	Stable audio input wait.....	47

8.4.2	Outputting audio .....	47
8.4.3	Audio to be output .....	47
8.4.4	Output audio for when no video signal is input .....	48
8.5	Input .....	49
8.5.1	HDCP input .....	49
8.5.2	No-signal input monitoring .....	50
8.6	Output .....	51
8.6.1	Hot plug ignoring duration .....	51
8.6.2	Sink device EDID check .....	52
8.6.3	Output format .....	53
8.6.4	Down conversion output .....	54
8.6.5	Presence of output signal for when signal is input .....	55
8.6.6	Presence of output signal for when no signal is input .....	56
8.7	LAN .....	57
8.7.1	IP address .....	57
8.7.2	Subnet mask .....	58
8.7.3	TCP port number .....	59
8.7.4	MAC address .....	60
8.8	Configuring VAC-S .....	60
8.8.1	Reboot .....	60
8.8.2	Grouping front panel security lockout .....	60
8.8.3	Power saving mode .....	61
8.8.4	Version .....	61
8.8.5	Displaying/Hiding menu .....	62
8.9	Status indication .....	63
8.9.1	Input signal status .....	63
8.9.2	Sink device status .....	67
8.9.3	System status .....	71
8.10	Operations only settable from WEB menu .....	72
8.10.1	Editing channel and device names .....	72
8.10.2	Automatic updating time .....	72
8.10.3	Saving/Restoring all settings .....	72
8.10.4	Initialization .....	73
9	License .....	74
10	Product specification .....	75
10.1	VAC-S12U .....	75
10.2	VAC-S14U .....	76
10.3	VAC-S16U .....	77
10.4	VAC-S18U .....	78
11	Troubleshooting .....	79

# 1 Included items

Ensure that all items illustrated below are included in the package.

If any items are missing or damaged, please contact IDK.

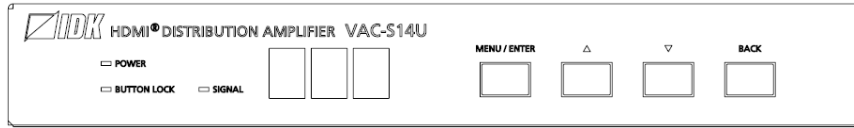

One (1) main unit (Example: VAC-S14U)

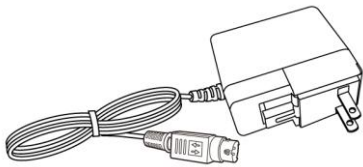

One (1) AC adapter (4 ft. (1.2 m))

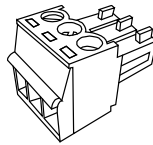

3-pin captive screw connector  
 VAC-S12U × 2 VAC-S14U × 1  
 VAC-S16U × 1 VAC-S18U × 1

**[Fig. 1.1] Included items**

## 2 About VAC-S

The VAC-S series (hereafter referred to as “VAC-S”) is a HDCP 2.2 compliant distribution amplifier supporting signals up to 4K at 60 Hz (4:4:4). It features one HDMI input, 2, 4, 6, or 8 HDMI outputs, and one analog audio outputs. The VAC-S12U includes an audio input connector for analog audio input.

Input video signal is distributed and output from HDMI output connectors while embedded audio signal is converted into analog audio signal and output from the audio output connector.

OUT1 includes a down converter that enables 4K input video signals to be converted automatically to 1080p if the sink device does not support 4K.

Output signals can be set to muted (black screen) or disabled for each channel separately.

Input and output signals of all VAC-S units in the system can be monitored from WEB browser for problem analysis.

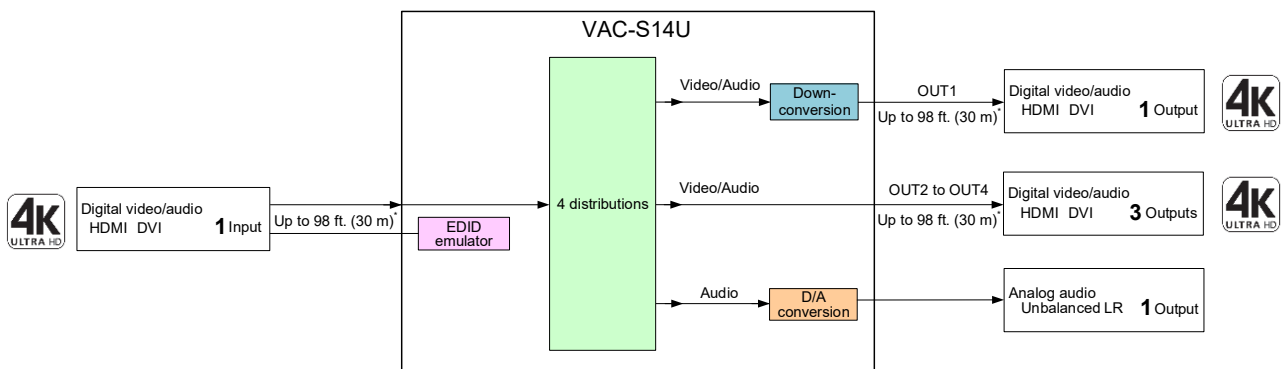

\* Maximum transmission distances  
 98 ft. (30 m) : 1080p@60  
 39 ft. (12m) : 4K@60 (when cable supporting 18 Gbps transmission is used)

**[Fig. 2.1] VAC-S14U diagram**

## 3 Features

---

### ■ Video

- One HDMI signal is distributed and output to two, four, six, or eight outputs simultaneously (VAC-S12U/VAC-S14U/VAC-S16U/VAC-S18U)
- Up to 4K@60 (4:4:4)
- HDCP 1.4/2.2
- HDR
- 3D
- x.v.Color
- HDMI Transmission distances:
  - Up to 98 ft. (30 m): 1080p@60
  - Up to 39 ft. (12 m): 4K@60 (when cable supporting 18 Gbps transmission is used)
- OUT1 supports down conversion (4K to 1080p)
- Each video output can be off or muted separately
- Cascade connection
- Anti-snow

### ■ Audio

- De-embedding
- Embedding (VAC-S12U only)

### ■ Control input

- LAN

### ■ Others

- Status notification
- I/O signal status display
- EDID emulation
- DDC buffer
- WEB browser control
- CEC (Pass-through)
- Connection Reset
- Button security lockout
- AC adapter with locking mechanism
- System check

### 3.1 Down conversion

If the input signal is 4K resolution, the VAC-S is capable of converting 4K resolution to 1080p.

If the connected sink device support only up to 2K format and down conversion output is set to “FOLLOW SINK EDID”, the output signal can be converted from 4K to 1080p automatically.

【See: 8.6.4 Down conversion output】

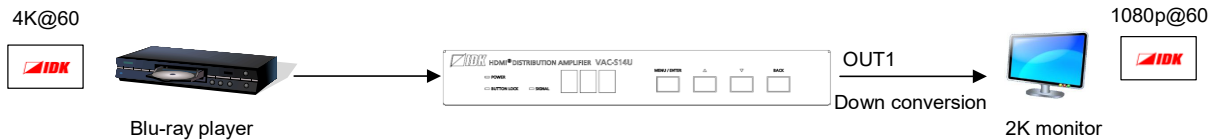

[Fig. 3.1] Down conversion

**Note:**

Down-converted signal is output from OUT1 only.

### 3.2 Output mode for when signal is input

Video and audio can be off for each output channel separately.

Off : No signal is output from the VAC-S. The connected monitors can be standby mode and save energy.

Black : A black screen is output from the VAC-S. Since the video is just hidden, the video can be displayed sooner after changing the mode.

If “Video output OFF”, “Black output ON”, or “Audio output OFF” is selected, the “BACK” button can be used to enable/disable this function.

If returning to the top page with this setting enabled, the “BACK” button illuminates. By pressing the button again while the button illuminates, this setting will be disabled and the button LED is turned off.

【See: 8.6.5 Presence of output signal for when signal is input】

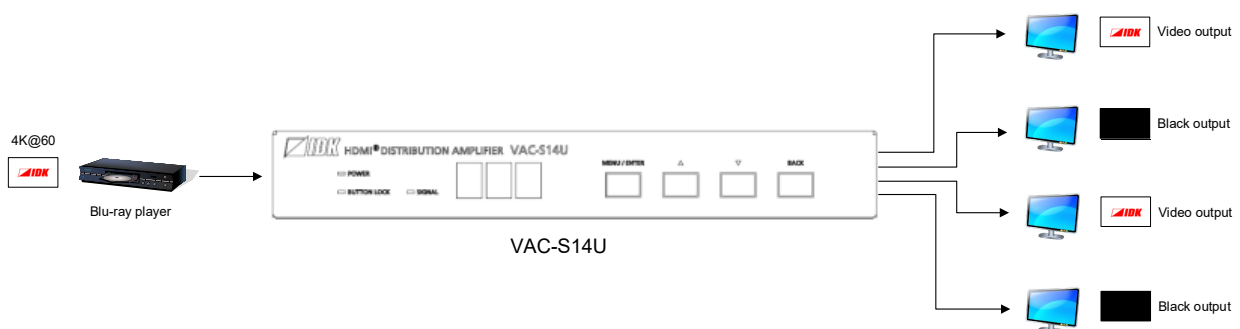

[Fig. 3.2] Video off (Example)

**Note:**

The function for displaying a black screen is available only if video signal is input.

### 3.3 LAN

The VAC-S can be accessed and controlled through LAN communication.

The VAC-S does not support automatic acquisition of IP address using DHCP (Dynamic Host Configuration Protocol). If you use the VAC-S in a network with DHCP, use a fixed IP address.

[See: 8.7.1 IP address]

### 3.4 Control from Web browser

To open the Web menu window, enter the IP address + “/menu.html” into the address bar.

[MENU]: Shows all settable items.

[VIEW STATUS]: Shows information of I/O signals and connected devices.

[See: 8.7.1 IP address]

**VAC-S18U HDMI DISTRIBUTION AMPLIFIER**

[ MENU ]	[ VIEW STATUS ]				
<ul style="list-style-type: none"> <li>CHANNEL SELECT</li> <li>INPUT SETTINGS</li> <li>OUTPUT SETTINGS</li> <li>INPUT AUDIO SETTINGS</li> <li>OUTPUT AUDIO SETTINGS</li> <li>EDID SETTINGS</li> <li>LAN SETTINGS</li> <li>SYSTEM SETTINGS</li> <li style="background-color: #f0f0f0;">VIEW STATUS</li> </ul>	<p>INPUT STATUS</p> <p>VIDEO STATUS : IN                      FORMAT : 3840x2160p 59.94Hz                      INPUT MODE : HDMI MODE                      HDCP : HDCP 2.2 Type0                      COLOR SPACE : 422 LIMITED RANGE YUV709                      DEEP COLOR : 24 BIT COLOR                      SCRAMBLE : SCRAMBLE ON</p> <p>AUDIO STATUS : IN                      FORMAT : LINEAR PCM                      SAMPLING FREQUENCY : 48 kHz                      CHANNEL : 2 CHANNEL                      BIT LENGTH : 24 BIT</p>	<p>SINK DEVICE STATUS</p> <p>OUT1 - OUT4</p> <p>HDCP AUTHENTICATION : HDCP 2.2 Type 0                      OUTPUT MODE : HDMI MODE                      COLOR SPACE : 422                      COLOR RANGE : LIMITED RANGE                      DEEP COLOR : 24 BIT COLOR                      SCRAMBLE : SCRAMBLE ON</p>	<p>OUT2</p> <p>HDCP 2.2 Type 0                      HDMI MODE                      422                      LIMITED RANGE                      24 BIT COLOR                      SCRAMBLE ON</p>	<p>OUT3</p> <p>HDCP 2.2 Type 0                      HDMI MODE                      422                      LIMITED RANGE                      24 BIT COLOR                      SCRAMBLE ON</p>	<p>OUT4</p> <p>HDCP 2.2 Type 0                      HDMI MODE                      422                      LIMITED RANGE                      24 BIT COLOR                      SCRAMBLE ON</p>
	<p>SINK DEVICE EDID</p> <p>MONITOR NAME : HDC-RH421UHD                      RESOLUTION : 3840x2160 594.00MHz                      HDMI/DVI : HDMI MODE                      COLOR SPACE : RGB / 422 / 444 / 420                      DEEP COLOR : 24 BIT COLOR                      PCM FREQUENCY : 32 / 44 / 48 kHz                      PCM BIT LENGTH : 16 / 20 / 24 BIT                      PCM CHANNEL : 2 CHANNEL                      COMPRESSED AUDIO : NOT SUPPORTED                      HDR : NOT SUPPORTED                      SDC : SUPPORTED                      3D : NOT SUPPORTED</p>	<p>OUT2</p> <p>ICP-401UHD                      3840x2160 594.00MHz                      HDMI MODE                      RGB / 422 / 444 / 420                      24 BIT COLOR                      32 / 44 / 48 kHz                      16 / 20 / 24 BIT                      2 CHANNEL                      NOT SUPPORTED                      NOT SUPPORTED                      SUPPORTED                      NOT SUPPORTED</p>	<p>OUT3</p> <p>MSD-802UHD                      3840x2160 594.00MHz                      HDMI MODE                      RGB / 422 / 444 / 420                      24 BIT COLOR                      32 / 44 / 48 kHz                      16 / 20 / 24 BIT                      2 CHANNEL                      NOT SUPPORTED                      NOT SUPPORTED                      SUPPORTED                      NOT SUPPORTED</p>	<p>OUT4</p> <p>VAC-S12U                      3840x2160 594.00MHz                      HDMI MODE                      RGB / 422 / 444 / 420                      24 BIT COLOR                      32 / 44 / 48 kHz                      16 / 20 / 24 BIT                      2 CHANNEL                      NOT SUPPORTED                      NOT SUPPORTED                      SUPPORTED                      NOT SUPPORTED</p>	
	<p>SYSTEM STATUS</p> <p>TEMPERATURE : 42.5 C                      POWER : 12.102 V</p>				
	<p>VERSION</p> <p>VAC-S18U : 01.00.00</p>				

[Fig. 3.3] WEB menu

## 4 Panels

### 4.1 Front panel

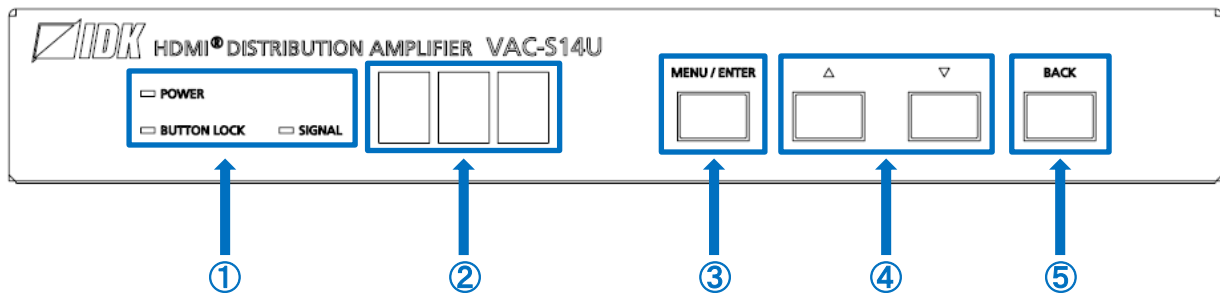

[Fig. 4.1] Front panel drawings (VAC-S14U)

[Table 4.1] Front panel features

#	Feature	Description
①	LED indicators	<p>POWER : Illuminates when power is supplied from the AC adapter.</p> <p>BUTTON LOCK : Illuminates when the MENU/ENTER button is locked.                      【See: 7.3 Front panel security lockout】</p> <p>SIGNAL : Illuminates when video signal is input.                      Does not illuminate when no video signal is input.</p>
②	7-Segment display	When powered on, displays device name and then the light is turned off. Pages for setting menus display menu number, settings, setting status, or other values related to the menu. After 60 seconds of menu operation buttons* inactivity, it goes back to the top page.
③	MENU/ENTER button	Enters menu and selects options.
④	▲/▼ buttons	Scrolls menu or selects values.
⑤	BACK button	Available only in menu page. Goes back to the previous page. If “8.6.5 Presence of output signal for when signal is input” is set to off or mute this button can be used as on/off switching button.

\*Menu operation buttons: ③, ④, and ⑤ in the menu page.

## 4.2 Rear panel

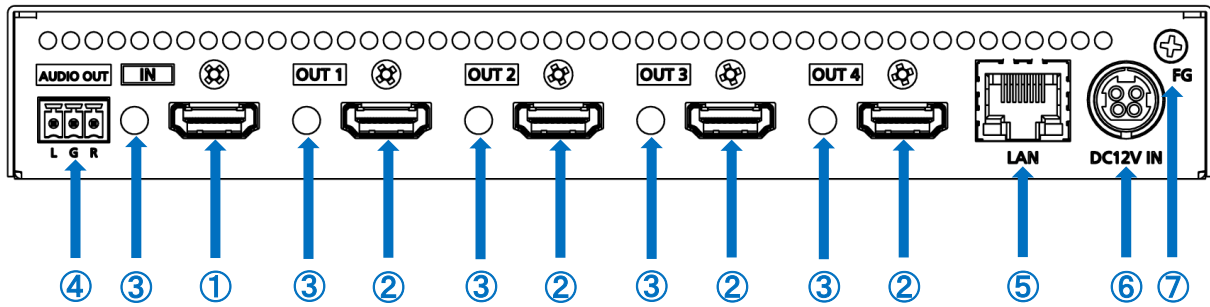

[Fig. 4.2] Rear panel drawing (VAC-S14U)

[Table 4.2] Rear panel features

#	Feature	Description
①	HDMI input connector	Input connectors for HDMI and DVI signals to interface source devices, such as Blu-ray players.
②	HDMI output connectors	Output connectors for HDMI and DVI signals, interfaces sink devices such as LC monitors and projectors.
③	HDMI cable fixing holes (Not used)	Not used.
④	Analog audio output connector	3-pin captive screw analog audio output connector interfaces amplifiers, speakers, and mixers 【See: 6.2.3 Connecting audio cable】
⑤	LAN connector	For external control by communication commands or web browsers 【See: 6.3 Connecting LAN cable】
⑥	Power supply connector	For use with supplied AC adapter
⑦	Frame ground	Use for bonding chassis to local ground. An M3 screw is used.
-	Analog audio input connector (VAC-S12U only)	Input connector for analog audio signals 【See: 6.2.3 Connecting audio cable】

## 5 System Configuration Example

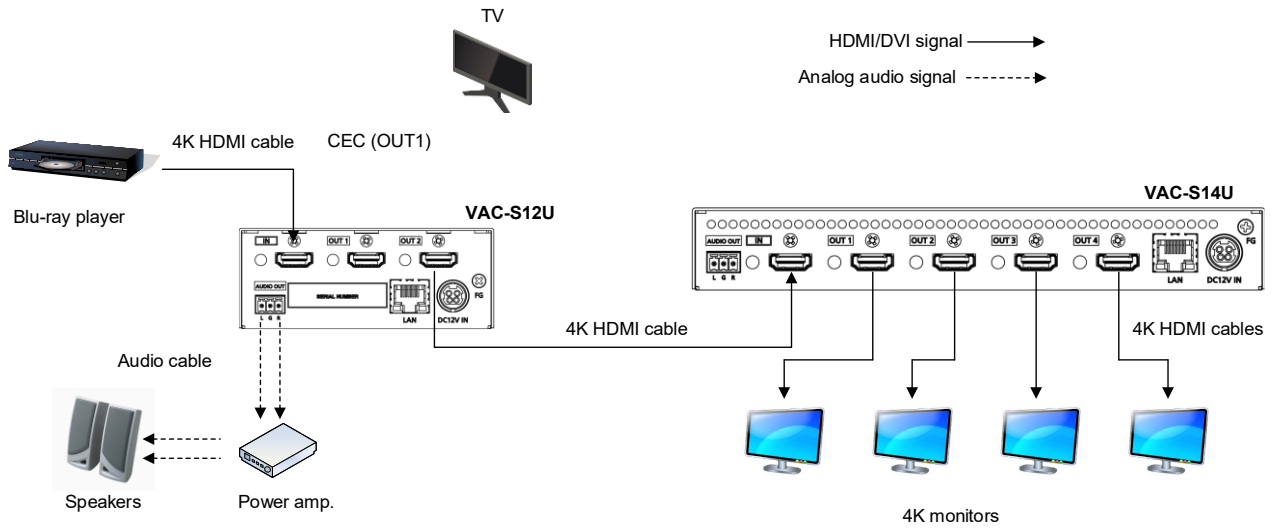

[Fig. 5.1] Application example (VAC-S)

## 6 Precautions

---

Before connecting to external devices, follow the precautions below.

### 6.1 Installation

---

When installing the VAC-S, observe the following precautions; otherwise, the internal temperature increases and it may affect the product lifetime and operation.

- Do not stack or place one VAC-S directly on top of another VAC-S.
- Do not block vent holes.

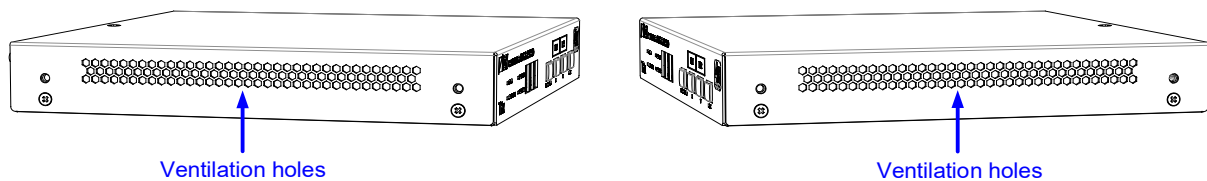

[Fig. 6.1] Ventilation holes

- To provide adequate ventilation, maintain sufficient clearances around the VAC-S (1.2 in. (30 mm) or more).
- Consider installing the VAC-S in an environment compatible with the maximum temperature indicated in the specification sheet 32°F to 104°F (0°C to +40°C).

**Tip:**

For installing the VAC-S in an EIA rack, we offer optional rack mounting hardware. Please contact us as needed.

### 6.2 Connection details

---

When connecting the VAC-S to external devices, observe the following precautions.

- Read manuals for the external devices.
- Before connecting cables to the VAC-S or an external device, dissipate static electricity by touching grounded metal such as equipment racks before handling signal cables. Failure to observe this precaution may result in ESD (electrostatic discharge) damage.
- Power all units off before connecting cables.
- Be sure to fully seat all plugs and connections and dress cables to reduce stress on connectors.

## 6.2.1 HDMI cable

When the video is 4K format, the maximum TMDS data rate (transmission speed) is 18 Gbps. If a high-speed HDMI cable is used, the maximum TMDS data rate of 10.2 Gbps can be transferred, and the video cannot be displayed stably.

Please select an 18 Gbps high-speed cable depending on the 4K format. The maximum transmission distance depends on the cable type, source and sink devices. You are recommended to use high quality cables.

**[Table 6.1] 18 Gbps high-speed cable for 4 K format**

	TMDS data rate (Gbps)								
	RGB, YCbCr 4:4:4			YCbCr 4:2:2			YCbCr 4:2:0		
4K format	24 bit	30 bit	36 bit	24 bit	30 bit	36 bit	24 bit	30 bit	36 bit
3840x2160p (24/25/30)	10.2 Gbps	18 Gbps	18 Gbps	10.2 Gbps	10.2 Gbps	10.2 Gbps	N/A	N/A	N/A
4096x2160 (24/25/30)	10.2 Gbps	18 Gbps	18 Gbps	10.2 Gbps	10.2 Gbps	10.2 Gbps	N/A	N/A	N/A
3840x2160p (50/59.94/60)	18 Gbps	N/A	N/A	18 Gbps	18 Gbps	18 Gbps	10.2 Gbps	18 Gbps	18 Gbps
4096x2160 (50/59.94/60)	18 Gbps	N/A	N/A	18 Gbps	18 Gbps	18 Gbps	10.2 Gbps	18 Gbps	18 Gbps

18 Gbps: 18 Gbps high-speed cable; 10.2 Gbps: 10.2 Gbps cable

**Note:**

If a cable is extended and a cable joint (JJ) is used, video may be interrupted or may not be output.

## 6.2.2 Cable Lacing Bracket

Use the cable lacing bracket to secure a standard HDMI cable as shown.

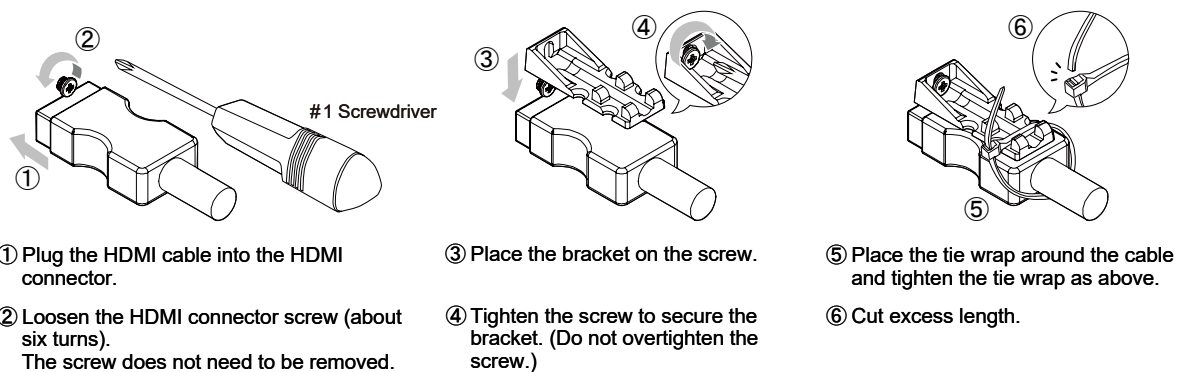

**[Fig. 6.2] Cable Lacing Bracket (FB-01 For IDK products only)**

### 6.2.3 Connecting audio cable

Connect audio cables to the 3-pin captive screw connectors.  
 24 AWG to 16 AWG conductor gauge and a strip length of 0.28 in. (7 mm) are recommended.

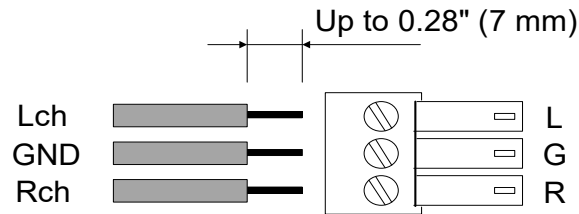

[Fig. 6.3] Connecting audio cable to 3-pin captive screw connector

### 6.3 Connecting LAN cable

Pin assignment of the LAN connector is as follows.  
 Auto MDI/MDI-X that detecting and switching straight cable/cross cable is supported.

Light in orange if the send/receive rate is 100 Mbps.  
 Goes off if it is 10 Mbps.

Light in green while link is established.  
 Blinks in green while data is being sent/received.

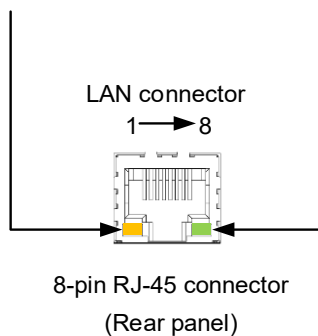

Pin#	Signal Name	
	MDI	MDI-X
1	TX+ (Transmitted Data +)	RX+ (Received Data +)
2	TX- (Transmitted Data -)	RX- (Received Data -)
3	RX+ (Received Data +)	TX+ (Transmitted Data +)
4	N.C. (Not Connected)*	N.C. (Not Connected)*
5	N.C. (Not Connected)*	N.C. (Not Connected)*
6	RX- (Received Data -)	TX- (Transmitted Data -)
7	N.C. (Not Connected)*	N.C. (Not Connected)*
8	N.C. (Not Connected)*	N.C. (Not Connected)*

\*Not used

[Fig. 6.4] LAN connector

## 6.4 DIN plug AC adapter with locking mechanism

The shapes of AC plugs with screw locking mechanism vary from country to country. The AC plug can be removed from the AC adapter.

### Removing AC plug:

Slide the AC plug (②) from the AC adapter while holding down the portion mentioned below (①)

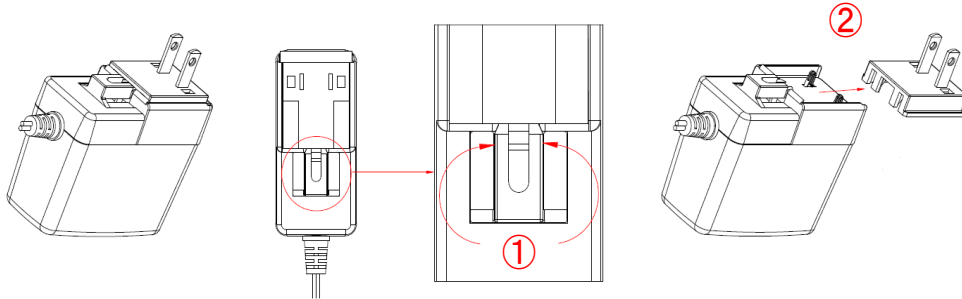

[Fig. 6.5] Removing AC plug (Example: Plug type A)

### Attaching AC plug:

Gently slide the AC plug into the AC adapter (③) until it clicks (④)

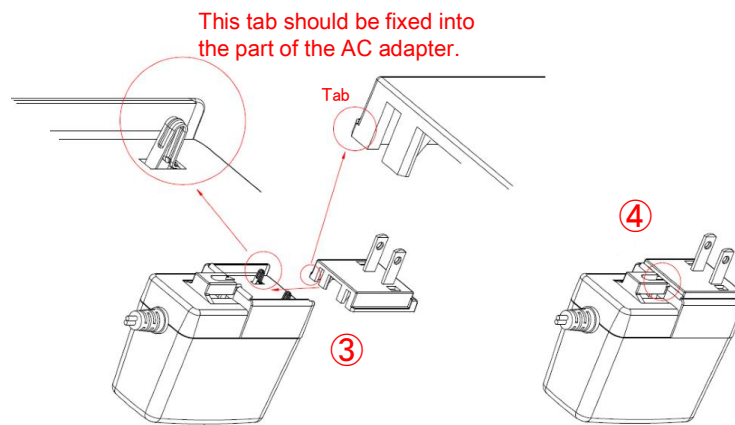

[Fig. 6.6] Attaching AC plug (Example: Plug type A)

■ **Plugging and unplugging DC plug**

Plug the DC plug to the power supply connector of the unit until it clicks.  
 Hold the portion mentioned below when unplugging the DC plug.

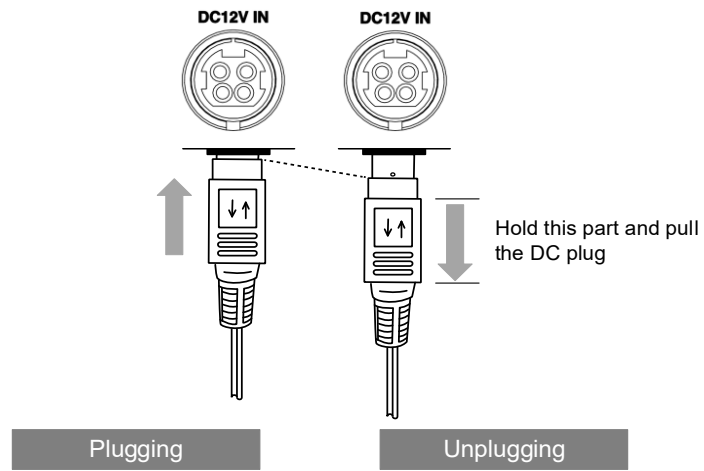

**[Fig. 6.7] Plugging and unplugging DC plug**

## 7 Basic Operation

### 7.1 Menu operation

Selecting menu number

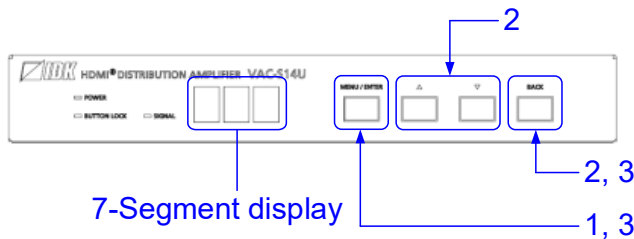

Selecting setting number

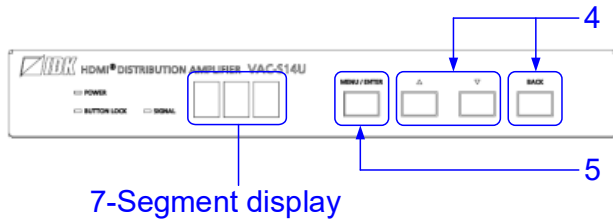

- 1 Press the “MENU/ENTER” button to display a menu number.

---

- 2 Use the “▲”/“▼” buttons to select the desired menu number.  
If returning to the top page, the light is turned off.

---

- 3 Press the “MENU/ENTER” button to display a setting value.  
Press the “BACK” button to go back to Step 2.

---

- 4 Use the “▲”/“▼” buttons to select the desired value for the menu.  
If you do not touch the button for 10 seconds, it goes back to Step 2.  
Press the “BACK” button to go back to the Step 2.

---

- 5 Press the “MENU/ENTER” button to apply the setting.  
The menu number displays again.

**Note:**

After 60 seconds of menu operation buttons\* inactivity, the menu goes back to the top page and the light turned off.

[Fig. 7.1] Setting from front buttons

## 7.2 WEB operation

JavaScript is used for the VAC-S WEB browser. When you set the VAC-S from WEB browser menu, enable JavaScript before setting up. Refer to each browser's help menu if you do not know how to enable JavaScript.

To open the Web menu window, enter the IP address + "/menu.html" into the address bar.

【See: 8.7.1 IP address】



【Fig. 7.2】 WEB menu

## 7.2.1 WEB browser

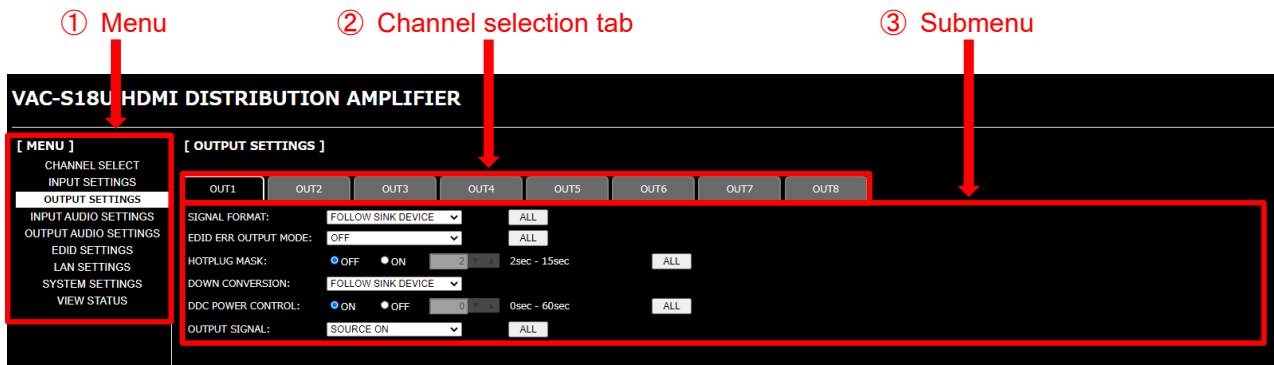

[Fig. 7.3] WEB menu

- ① Select the desired item from the menu to display setting items in the submenu.
- ② If there is a setting item that can be set for each channel, channel tab will be displayed.
- ③ Set items in the submenu by referring to the table below.

[Table 7.1] Form control

Form control	Example	Description
Set/execution button	<input type="button" value="SET"/>	Click the button to execute the desired operation.
Pull down list	<input type="text" value="OUT1"/> ▼	Use the down button to select the desired value.
Arrow button	<input type="text" value="10"/> ▼ ▲	Use the up/down buttons to set the desired value. You also can enter the value directly.
Radio button	<input type="radio"/> OFF <input checked="" type="radio"/> ON	Select one of options.

## 7.3 Front panel security lockout

Press and hold the "BACK" button for three seconds or longer to set/cancel button lock.

If powering off the VAC-S with the buttons locked, the VAC-S starts up with the buttons locked next time.

【See: 8.8.2 Grouping front panel security lockout】

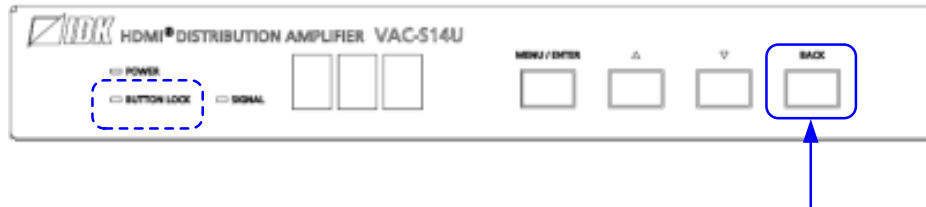

Press and hold the BACK button to enable/disable button security lockout.

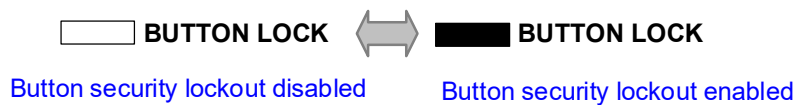

[Fig. 7.4] Locking/unlocking (VAC-S14U)

### Tip:

If button security lockout is set to be enabled while menu is displayed, it will be back to the top page.

## 7.4 Unsolicited status notification

If status is changed or a problem is detected, the unsolicited status notice will be sent via LAN communication.

To enable this feature, execute the command by referring to the command guide.

## 7.5 Initialization

All user configurable settings can be reset to their respective factory default values by powering the VAC-S on while pressing and holding the “BACK” button. “CLr” is displayed on the 7-Segment display during initialization, and the device name is displayed when settings are initialized.

Note that after returning to factory default, the previous setting values cannot be restored.

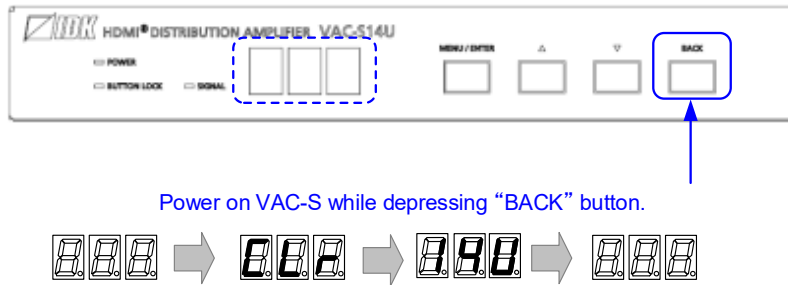

[Fig. 7.5] Initialization

## 8 Menu

You can set the VAC-S from the front buttons or Web browser.

[Table 8.1] Menu number and menu name

Front menu	WEB menu	Function	Page
F01 to F03	EDID SETTINGS → SINK DEVICE EDID COPY	Copying EDID	35
F10	EDID SETTINGS → RESOLUTION	Resolution	36
F12	EDID SETTINGS → CH.FOR EXTERNAL MODE	External EDID	39
F14	EDID SETTINGS → CH.FOR COPY MODE	Selecting copied EDID	40
F16	INPUT SETTING → NO INPUT MONITORING	No-signal input monitoring	50
F20	EDID SETTINGS → DEEP COLOR	Deep Color	41
F22	EDID SETTINGS → AUDIO FORMAT	LPCM audio	41
F24		AC-3 Dolby Digital audio	42
F26		AAC audio	42
F28		Dolby Digital Plus audio	43
F30		DTS audio	43
F32		DTS-HD audio	44
F34		Dolby TrueHD audio	44
F36		EDID SETTINGS → SPEAKER CONFIGURATION	Speaker configuration
F38	EDID SETTINGS → CEC ADDRESS COPY	Copying CEC physical address	46
F40	EDID SETTINGS → FRAME RATE	Frame rate	46
F70 to F7n <sup>1</sup> F78 <sup>2</sup>	OUTPUT AUDIO SETTINGS → OUTPUT SIGNAL	Outputting audio	47
F80, F81, F88	OUTPUT AUDIO SETTINGS → SOURCE SELECTION	Audio to be output <sup>2</sup>	47
F90	VIEW STATUS → VERSION	Version	61
F99	–	Displaying/Hiding menu	62
C01	INPUT SETTINGS → HDCP INPUT MODE	HDCP input	49
C06	INPUT AUDIO SETTINGS → STABLE WAIT	Stable audio input wait	47
C10 to C1n <sup>*</sup>	OUTPUT SETTINGS → HOTPLUG MASK	Hot plug ignoring duration	51
C20 to C2n <sup>*</sup>	OUTPUT SETTINGS → EDID ERR. OUTPUT MODE	Sink device EDID check	52
C30 to C3n <sup>*</sup>	OUTPUT SETTINGS → SIGNAL FORMAT	Output format	53
C40	OUTPUT SETTINGS → DOWN CONVERSION	Down conversion output	54
C50 to C5n <sup>*</sup>	OUTPUT SETTINGS → OUTPUT SIGNAL	Presence of output signal for when signal is input	55
C60 to C6n <sup>*</sup>	OUTPUT SETTINGS → DDC POWER CONTROL	Presence of output signal for when no signal is input	56
C68, C69	OUTPUT SETTINGS → AUDIO ONLY OUTPUT	Output audio for when no video signal is input <sup>2</sup>	48
C80 to C83	LAN SETTINGS → IP ADDRESS	IP address	57
C84	LAN SETTINGS → SUBNET MASK	Subnet mask	58
C85	LAN SETTINGS → PORT NUMBER	TCP port number	59
C86	LAN SETTINGS → MAC ADDRESS	MAC address	60
C91	SYSTEM SETTINGS → REBOOT	Reboot	60
C92	SYSTEM SETTINGS → BUTTON LOCK	Grouping front panel security lockout	60
C93	SYSTEM SETTINGS → POWER SAVE MODE	Power saving mode	61
L01 to L22	VIEW STATUS → INPUT STATUS	Input signal status	63
L30 to LLn <sup>*</sup>	VIEW STATUS → SINK DEVICE STATUS / SINK DEVICE EDID	Sink device status	67
H00 to H02	VIEW STATUS → SYSTEM STATUS	System status	71

<sup>1</sup>VAC-S12U: n=1, VAC-S14U: n=3, VAC-S16U: n=5, VAC-S18U: n=7

<sup>2</sup>VAC-S12U only

## 8.1 Front menu

You can set the following three settings using front buttons:

- Setting video or audio signals (Setting menu)
- Checking operations (Maintenance menu)
- Displaying VAC-S's status (Status indication menu)

Menu number and target channels vary depending on your model (VAC-S12U/VAC-S14U/VAC-S16U/VAC-S18U). The maximum number of output is 8, and the lists below are based on the number, 8.

### ■ Setting menus

Set video and audio signals for normal use.

[Table 8.2] Setting menu

Menu number	Function	Page
F01 to F03	Copying EDID	35
F10	Resolution	36
F12	External EDID	39
F14	Selecting copied EDID	40
F16	No-signal input monitoring	50
F20	Deep Color	41
F22	LPCM audio	41
F24	AC-3 Dolby Digital audio	42
F26	AAC audio	42
F28	Dolby Digital Plus audio	43
F30	DTS audio	43
F32	DTS-HD audio	44
F34	Dolby TrueHD audio	44
F36	Speaker configuration	45
F38	Copying CEC physical address	46
F40	Frame rate	46
F70 to F7n* <sup>1</sup> F78* <sup>2</sup>	Outputting audio	47
F80, F81, F88	Audio to be output* <sup>2</sup>	47
F90	Version	61
F99	Displaying/Hiding menu	62

\*<sup>1</sup>VAC-S12U: n=1, VAC-S14U: n=3, VAC-S16U: n=5, VAC-S18U: n=7

\*<sup>2</sup>VAC-S12U only

### ■ Maintenance menus

Set necessary items for checking operation.

The maintenance menus are not displayed by default. To display the menus, change the setting of “8.8.5 Displaying/Hiding menu”.

[Table 8.3] Maintenance menu

Menu number	Function	Page
C01	HDCP input	49
C06	Stable audio input wait	47
C10 to C1n*	Hot plug ignoring duration	51
C20 to C2n*	Sink device EDID check	52
C30 to C3n*	Output format	53
C40	Down conversion output	54
C50 to C5n*	Presence of output signal for when signal is input	55
C60 to C6n*	Presence of output signal for when no signal is input	56
C68, C69	Output audio for when no video signal is input* <sup>2</sup>	48
C80 to C83	IP address	57
C84	Subnet mask	58
C85	TCP port number	59
C86	MAC address	60
C91	Reboot	60
C92	Grouping front panel security lockout	60
C93	Power saving mode	61

\*<sup>1</sup>VAC-S12U: n=1, VAC-S14U: n=3, VAC-S16U: n=5, VAC-S18U: n=7

\*<sup>2</sup>VAC-S12U only

### ■ Status indication menus

Display input status, connection status of sink devices, and the VAC-S's status.

The Status indication menus are not displayed by default. To display the menus, change the setting of “8.8.5 Displaying/Hiding menu”.

[Table 8.4] Status indication menu

Menu number	Function	Page
L01 to L22	Input signal status	63
L30 to LLn*	Sink device status	67
H00 to H02	System status	71

\*VAC-S12U: n=1, VAC-S14U: n=3, VAC-S16U: n=5, VAC-S18U: n=7

## 8.2 WEB browser menu

The VAC-S can be controlled from a WEB browser through LAN.

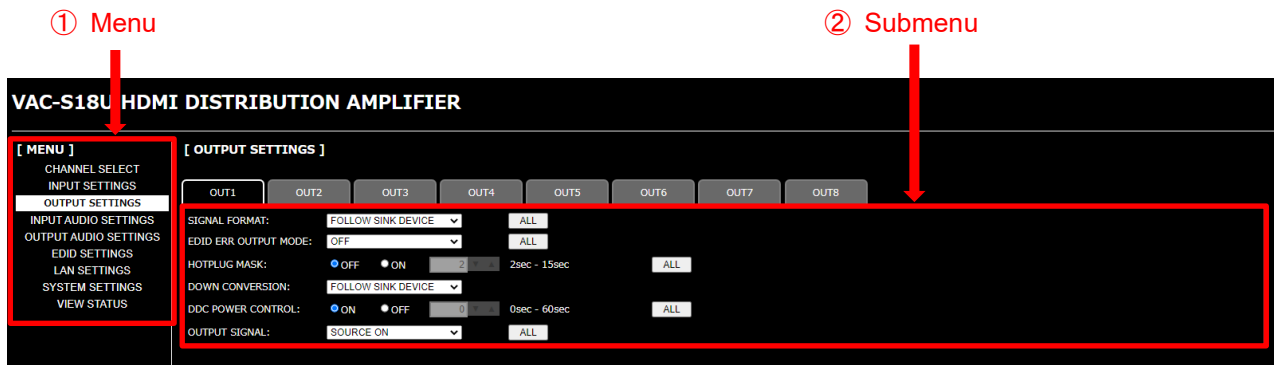

[Fig. 8.1] WEB menu

[Table 8.5] Menu and submenu

[1/2]

Menu	Submenu	Function	Page
CHANNEL SELECT	OUTPUT SIGNAL	Presence of output signal for when signal is input	55
INPUT SETTINGS	NO INPUT MONITORING	No-signal input monitoring	50
	HDCP INPUT MODE	HDCP input	49
OUTPUT SETTINGS	SIGNAL FORMAT	Output format	53
	EDID ERR.OUTPUT MODE	Sink device EDID check	52
	HOTPLUG MASK	Hot plug ignoring duration	51
	DOWN CONVERSION	Down conversion output	54
	DDC POWER CONTROL	Presence of output signal for when no signal is input	56
	OUTPUT SIGNAL	Presence of output signal for when signal is input	55
INPUT AUDIO SETTINGS	STABLE WAIT	Stable audio input wait	47
OUTPUT AUDIO SETTINGS	OUTPUT SIGNAL	Outputting audio	47
	AUDIO ONLY OUTPUT	Output audio for when no video signal is input*	48
	SOURCE SELECTION	Audio to be output*	47

\* VAC-S12U only

Menu	Submenu	Function	Page	
EDID SETTINGS	RESOLUTION	Resolution	36	
	CH. FOR EXTERNAL MODE	External EDID	39	
	CH. FOR COPY MODE	Selecting copied EDID	40	
	DEEP COLOR	Deep Color	41	
	FRAME RATE	Frame rate	46	
	AUDIO FORMAT	LPCM audio	LPCM audio	41
		AC-3 Dolby Digital audio	AC-3 Dolby Digital audio	42
		AAC audio	AAC audio	42
		Dolby Digital Plus audio	Dolby Digital Plus audio	43
		DTS audio	DTS audio	43
		DTS-HD audio	DTS-HD audio	44
		Dolby TrueHD audio	Dolby TrueHD audio	44
	SPEAKER CONFIGURATION	Speaker configuration	45	
	CEC ADDRESS COPY	Copying CEC physical address	46	
CEC PHYSICAL ADDRESS	Displaying CEC physical address	46		
SINK DEVICE EDID COPY	Copying EDID	35		
LAN SETTINGS	IP ADDRESS	IP address	57	
	SUBNET MASK	Subnet mask	58	
	PORT NUMBER	TCP port number	59	
	MAC ADDRESS	MAC address	60	
SYSTEM SETTINGS	BUTTON LOCK	Grouping front panel security lockout	60	
	POWER SAVE MODE	Power saving mode	61	
	AUTO RELOAD TIME	Automatic updating time	72	
	BACKUP / RESTORE	Saving/Restoring all settings	72	
	REBOOT	Reboot	60	
	INITIALIZATION	Initialization	73	
VIEW STATUS	INPUT STATUS	Input signal status	63	
	SINK DEVICE STATUS	Sink device status	67	
	SINK DEVICE EDID	Sink device status	67	
	SYSTEM STATUS	System status	71	
	VERSION	Version	61	

## 8.3 EDID

EDID can be set using the following data:

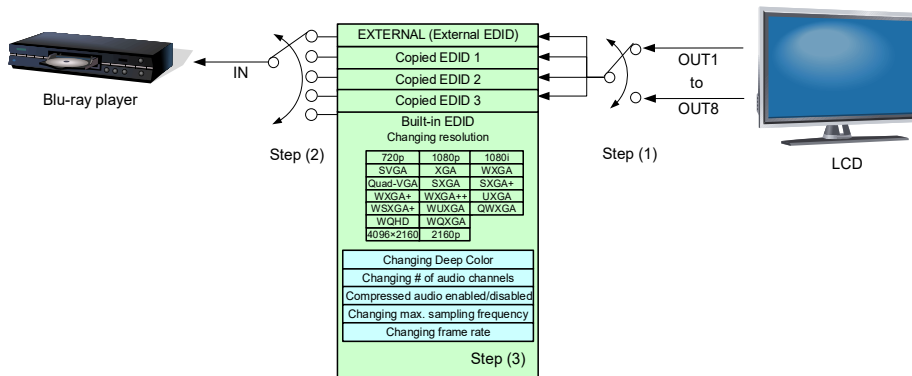

**[Fig. 8.2] Setting EDID**

Step 1: Select the target sink device for external EDID/copy EDIDs.

Skip this step if the built-in EDID is used.

【See: 8.3.1 Copying EDID】

【See: 8.3.3 External EDID】

Step 2: Set the EDID that will be sent to the source device.

【See: 8.3.2 Resolution】

【See: 8.3.4 Selecting copied EDID】

Step 3: If you use built-in EDID, customize the data as required.

【See: 8.3.5 Deep Color】

【See: 8.3.6 LPCM audio】

【See: 8.3.7 AC-3 Dolby Digital audio】

【See: 8.3.8 AAC audio】

【See: 8.3.9 Dolby Digital Plus audio】

【See: 8.3.10 DTS audio】

【See: 8.3.11 DTS-HD audio】

【See: 8.3.12 Dolby TrueHD audio】

【See: 8.3.13 Speaker configuration】

【See: 8.3.15 Frame rate】

### 8.3.1 Copying EDID

EDID of the sink device is loaded and registered to the VAC-S. The stored EDID can be treated as built-in EDID by registering the EDID.

Menu	F01 to F03: Copied data 1 to Copied data 3
WEB menu	EDID SETTINGS → SINK DEVICE EDID COPY
Setting value	

**[Table 8.6] Setting values for copying EDID**

Description	Front	WEB browser
OUT1 [Default]	01	OUT1 COPY1 to 3
OUT2	02	OUT2 COPY1 to 3
OUT3	03	OUT3 COPY1 to 3
OUT4	04	OUT4 COPY1 to 3
OUT5	05	OUT5 COPY1 to 3
OUT6	06	OUT6 COPY1 to 3
OUT7	07	OUT7 COPY1 to 3
OUT8	08	OUT8 COPY1 to 3

**To copy EDID:**

Step 1: Register the EDID of sink device to Copied data 1, 2, or 3. Menu number: [F01 to F03]

Step 2: Select the desired Copied data. Menu number: [F14]

【See: 8.3.4 Selecting copied EDID】

Step 3: Set EDID Resolution to “COPY (Copied EDID)”. Menu number: [F10]

【See: 8.3.2 Resolution】

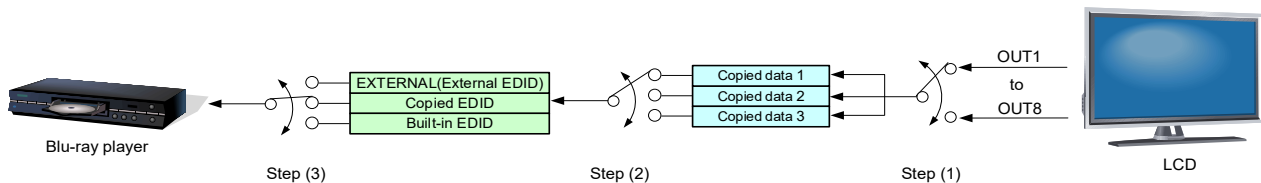

**[Fig. 8.3] Copying EDID (Example: VAC-S18U)**

**Note:**

For cascade connection, the source device reads EDID of the distribution amplifier (A) that is directly connected to the source device. If multiple distribution amplifiers are connected between source device and sink device, follow the procedure below to copy the EDID of sink device.

**To read EDID in cascade connection:**

Step 1: Copy the EDID of the sink device to the distribution amplifier (B).

Set EDID to “COPY (Copied EDID)” or “EXTERNAL (External EDID)”

Step 2: Copy the EDID of the distribution amplifier (B) to the distribution amplifier (A).

Set EDID to “COPY (Copied EDID)” or “EXTERNAL (External EDID)”



**[Fig. 8.4] Reading EDID in cascade connection**

## 8.3.2 Resolution

You can set the supported video resolution.

In order to use values “03 to 46” which are built-in EDID, set the “03 to 46 are the built-in EDID.

If using the internal EDID, specify the maximum supported resolution.

Menu	F10
WEB menu	EDID SETTINGS → RESOLUTION
Setting value	

Timing of 720p, 1080i, 1080p, 2560×1080, 2160p, and 4096×2160 is the same as that of HD signal meeting the CTA-861 standard.

For other resolutions, timing parameters meet the VESA DMT or VESA CVT standards.

HDR is supported if external EDID is selected while an HDR-supported sink device is connected for EDID setting or if copied EDID of an HDR-supported sink device is selected for EDID setting.

3D is supported if external EDID is selected while a 3D-supported sink device is connected for EDID setting or if copied EDID of 3D-supported sink device is selected for EDID setting.

【See: 8.3.3 External EDID】

【See: 8.3.4 Selecting copied EDID】

**[Table 8.7] Maximum resolution of EDID**

[1/2]

Setting value	Maximum resolution	Pixels	Standard	Remarks
01	EXTERNAL (External EDID)	—	—	If no sink device is connected, the last setting will be applied.
02	COPY (Copied EDID)	—	—	If no acquired data (EDID is not copied), “43” will be applied.
03	1080p	1920×1080	HDTV	
04	720p	1280×720		
05	1080i	1920×1080		
06	SVGA	800×600	VESA	
07	XGA	1024×768		
08	VESA720	1280×720	CVT	
09	WXGA	1280×768	VESA	
10	WXGA	1280×800		
11	Quad-VGA	1280×960		
12	SXGA	1280×1024		
13	WXGA	1360×768		
14	WXGA	1366×768		
15	SXGA+	1400×1050		
16	WXGA+	1440×900		
17	WXGA++	1600×900		(RB)
18	UXGA	1600×1200		
19	WSXGA+	1680×1050		
20	VESA1080	1920×1080	CVT	(RB)

[2/2]

Setting value	Maximum resolution	Pixels	Standard	Remarks
21	WUXGA	1920×1200	VESA	(RB)
22	QWXGA	2048×1152		(RB)
23	WQHD	2560×1440		(RB)
24	WQXGA	2560×1600		(RB)
41	2160p (24/25/30)	3840×2160	UHDTV	
42	2160p (50/59.94/60, 4:2:0)	3840×2160		YCbCr 4:2:0 supported
43	2160p (50/59.94/60, 4:4:4) [Default]	3840×2160		YCbCr 4:2:0, YCbCr 4:2:2, YCbCr 4:4:4 supported
44	4096x2160 (24/25/30)	4096×2160	DCI	
45	4096x2160 (50/59.94/60, 4:2:0)	4096×2160		YCbCr 4:2:0 supported
46	4096x2160 (50/59.94/60, 4:4:4)	4096×2160		YCbCr 4:2:0, YCbCr 4:2:2, YCbCr 4:4:4 supported

(RB): Reduced Blanking

**Notes:**

- For 4096x2160 (“44”, “45”, “46”)
  - The source device may select 3840x2160 (30p, YCbCr 4:4:4) depending on the EDID definition.
  - First set built-in EDID and then select 4096x2160 in the source device side.
- For YCbCr 4:2:0 (“42”, “45”)
  - The source device may select 3840x2160 (30p, YCbCr 4:4:4) depending on the EDID definition. First set built-in EDID and then select YCbCr 4:2:0 in the source device side.
- If a source device that does not support 4K is connected to an input connector having 4K EDID, the source device may output DVI signal meaning audio is not output. To output HDMI signal, change the EDID setting to a format other than 4K.

[Table 8.8] Maximum resolution and supported pixels

Max. resolution	Pixels	Supported Pixels																									
		640x480	800x600	1024x768	1280x720	1280x768	1280x800	1280x960	1280x1024	1360x768	1366x768	1400x1050	1440x900	1600x900	1600x1200	1680x1050	1920x1080	1920x1200	2048x1152	2560x1440	2560x1600	3840x2160 (30p)	4096x2160 (30p)	3840x2160 (60p)	4096x2160 (60p)		
01	—	—	—	—	—	—	—	—	—	—	—	—	—	—	—	—	—	—	—	—	—	—	—	—	—	—	
02	—	—	—	—	—	—	—	—	—	—	—	—	—	—	—	—	—	—	—	—	—	—	—	—	—	—	—
03	1080p	Y	Y	Y	N	N	Y	Y	Y	Y	Y	Y	Y	Y	Y	Y	Y	N	N	N	N	N	N	N	N	N	N
04	720p	Y	Y	N	Y	N	N	N	N	N	N	N	N	N	N	N	N	N	N	N	N	N	N	N	N	N	N
05	1080i	Y	Y	Y	N	N	N	N	N	N	N	N	N	N	N	N	N	N	N	N	N	N	N	N	N	N	N
06	800x600	Y	Y	N	N	N	N	N	N	N	N	N	N	N	N	N	N	N	N	N	N	N	N	N	N	N	N
07	1024x768	Y	Y	Y	N	N	N	N	N	N	N	N	N	N	N	N	N	N	N	N	N	N	N	N	N	N	N
08	1280x720	Y	Y	Y	Y	N	N	N	N	N	N	N	N	N	N	N	N	N	N	N	N	N	N	N	N	N	N
09	1280x768	Y	Y	Y	Y	Y	N	N	N	N	N	N	N	N	N	N	N	N	N	N	N	N	N	N	N	N	N
10	1280x800	Y	Y	Y	Y	Y	Y	N	N	N	N	N	N	N	N	N	N	N	N	N	N	N	N	N	N	N	N
11	1280x960	Y	Y	Y	Y	Y	Y	Y	N	N	N	N	N	N	N	N	N	N	N	N	N	N	N	N	N	N	N
12	1280x1024	Y	Y	Y	Y	Y	Y	Y	Y	N	N	N	N	N	N	N	N	N	N	N	N	N	N	N	N	N	N
13	1360x768	Y	Y	Y	Y	Y	Y	Y	Y	Y	N	N	N	N	N	N	N	N	N	N	N	N	N	N	N	N	N
14	1366x768	Y	Y	Y	Y	Y	Y	Y	Y	Y	Y	N	N	N	N	N	N	N	N	N	N	N	N	N	N	N	N
15	1400x1050	Y	Y	Y	Y	N	Y	Y	Y	Y	Y	Y	N	N	N	N	N	N	N	N	N	N	N	N	N	N	N
16	1440x900	Y	Y	Y	Y	N	Y	Y	Y	Y	Y	Y	Y	N	N	N	N	N	N	N	N	N	N	N	N	N	N
17	1600x900	Y	Y	Y	Y	N	Y	Y	Y	Y	Y	Y	Y	Y	N	N	N	N	N	N	N	N	N	N	N	N	N
18	1600x1200	Y	Y	Y	Y	N	Y	Y	Y	Y	Y	Y	Y	Y	Y	N	N	N	N	N	N	N	N	N	N	N	N
19	1680x1050	Y	Y	Y	Y	N	Y	Y	Y	Y	Y	Y	Y	Y	Y	Y	N	N	N	N	N	N	N	N	N	N	N
20	1920x1080	Y	Y	Y	N	N	Y	Y	Y	Y	Y	Y	Y	Y	Y	Y	Y	Y	N	N	N	N	N	N	N	N	N
21	1920x1200	Y	Y	Y	N	N	Y	Y	Y	N	N	Y	Y	Y	Y	Y	Y	Y	N	N	N	N	N	N	N	N	N
22	2048x1152	Y	Y	Y	N	N	N	Y	Y	N	N	Y	Y	Y	Y	Y	Y	Y	Y	Y	N	N	N	N	N	N	N
23	2560x1440	Y	Y	Y	N	N	N	N	Y	N	N	Y	Y	Y	Y	Y	Y	Y	Y	Y	Y	N	N	N	N	N	N
24	2560x1600	Y	Y	Y	N	N	N	N	Y	N	N	Y	Y	Y	Y	Y	Y	Y	Y	Y	Y	Y	N	N	N	N	N
41	2160p (24/25/30)	Y	Y	Y	N	N	N	N	Y	N	N	Y	Y	Y	Y	Y	Y	Y	Y	Y	Y	Y	Y	Y	N	N	N
42	2160p (50/59.94/60, 4:2:0)	Y	Y	Y	N	N	N	N	Y	N	N	Y	Y	Y	Y	Y	Y	Y	Y	Y	Y	Y	Y	Y	N	P	N
43	2160p (50/59.94/60, 4:4:4)	Y	Y	Y	N	N	N	N	Y	N	N	Y	Y	Y	Y	Y	Y	Y	Y	Y	Y	Y	Y	Y	N	Y	N
44	4096x2160 (24/25/30)	Y	Y	Y	N	N	N	N	Y	N	N	Y	Y	Y	Y	Y	Y	Y	Y	Y	Y	Y	Y	Y	Y	N	N
45	4096x2160 (50/59.94/60, 4:2:0)	Y	Y	Y	N	N	N	N	Y	N	N	Y	Y	Y	Y	Y	Y	Y	Y	Y	Y	Y	Y	Y	Y	P	P
46	4096x2160 (50/59.94/60, 4:4:4)	Y	Y	Y	N	N	N	N	Y	N	N	Y	Y	Y	Y	Y	Y	Y	Y	Y	Y	Y	Y	Y	Y	Y	Y

Y: Supported, P: Only YCbCr 4:2:0, N: Not supported, —: Not used

### 8.3.3 External EDID

You can set the output connector to be recalled when the EDID type is set to "EXTERNAL".

Menu F12  
 WEB menu EDID SETTINGS → CH.FOR EXTERNAL MODE  
 Setting value

**[Table 8.9] Setting values for External EDID**

Description	Front	WEB browser
OUT1 [Default]	01	OUT1
OUT2	02	OUT2
OUT3	03	OUT3
OUT4	04	OUT4
OUT5	05	OUT5
OUT6	06	OUT6
OUT7	07	OUT7
OUT8	08	OUT8

**To use external EDID:**

Step 1: Select the HDMI output connector to which the target sink device is connected.

Menu number [F12]

Step 2: Select "EXTERNAL (External EDID)".

Menu number [F10]

【See: 8.3.2 Resolution】

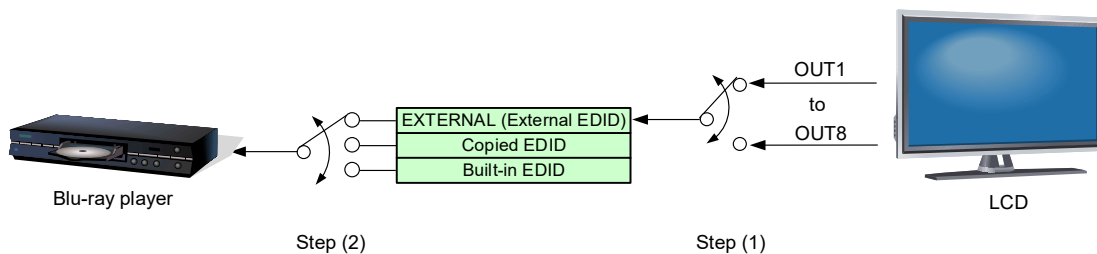

**[Fig. 8.5] External EDID (Example: VAC-S18U)**

### 8.3.4 Selecting copied EDID

You can select a copied EDID.

【See: 8.3.1 Copying EDID】

Menu	F14
WEB menu	EDID SETTINGS → CH.FOR COPY MODE
Setting value	

**[Table 8.10] Selecting copied EDID**

Description	Front	WEB browser
Copied data 1 [Default]	01	COPY1
Copied data 2	02	COPY2
Copied data 3	03	COPY3

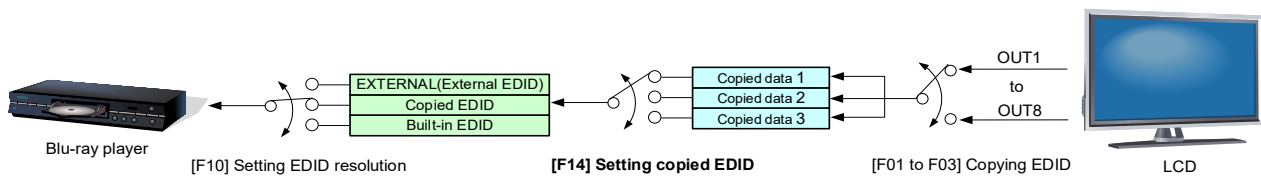

**[Fig. 8.6] Setting copied EDID (Example: VAC-S18U)**

### 8.3.5 Deep Color

You can set the color depth to be output from the source device.

Menu	F20
WEB menu	EDID SETTINGS → DEEP COLOR
Setting value	

[Table 8.11] Deep Color

Description	Front	WEB browser
24 bit/pixel (8 bit/component) [Default]	24	24 BIT COLOR
30 bit/pixel (10 bit/component)	30	30 BIT COLOR
36 bit/pixel (12 bit/component)	36	36 BIT COLOR

The setting will be applied only if “**8.3.2 Resolution**” is set to one of “03” to “46”.

**Notes:**

- If you select “30 bit/pixel (10 bit/component)” and “36 bit/pixel (12 bit/component)”, compared to “24 bit/pixel (8 bit/component)”, “30 bit/pixel (10 bit/component)” and “36 bit/pixel (12 bit/component)” are transmitted using a higher clock frequency. The clock frequency may cause noise if a poor-quality or an excessively long cable is connected.  
In such a case, the noise may be removed by setting the color to “24 bit/pixel (8 bit/component)”.
- For 4K format vertical synchronous frequency at 50/59.94/60 Hz (YCbCr 4:4:4), “24 bit/pixel (8 bit/component)” is selected automatically regardless of the setting of this menu.

### 8.3.6 LPCM audio

Menu	F22
WEB menu	EDID SETTINGS → AUDIO FORMAT → Linear PCM
Setting value	

[Table 8.12] LPCM audio

Description	Front	WEB browser
32 kHz	32	32kHz
44.1 kHz	44	44.1kHz
48 kHz [Default]	48	48kHz
88.2 kHz	88	88.2kHz
96 kHz	96	96kHz
176.4kHz	176	176.4kHz
192 kHz	192	192kHz

The setting will be applied only if “**8.3.2 Resolution**” is set to one of “03” to “46”.

You can set the maximum sampling frequency of LPCM that is output from the source device.

**Note:**

LC monitors may not support some high sampling frequencies.

### 8.3.7 AC-3 Dolby Digital audio

---

You can set the AC-3 Dolby Digital audio to be output from the source device.

Menu **F24**  
 WEB menu EDID SETTINGS → AUDIO FORMAT → Dolby Digital  
 Setting value

**[Table 8.13] AC-3 Dolby Digital audio**

Description	Front	WEB browser
OFF [Default]	oFF	OFF
32 kHz	32	32kHz
44.1 kHz	44	44.1kHz
48 kHz	48	48kHz

The setting will be applied only if “**8.3.2 Resolution**” is set to one of “03” to “46”.

**Note:**

LC monitors do not support some audio formats. Select an audio format and sampling frequency supported by the device.

### 8.3.8 AAC audio

---

You can set the AAC audio to be output from the source device.

Menu **F26**  
 WEB menu EDID SETTINGS → AUDIO FORMAT → AAC  
 Setting value

**[Table 8.14] AAC audio**

Description	Front	WEB browser
OFF [Default]	oFF	OFF
32 kHz	32	32kHz
44.1 kHz	44	44.1kHz
48 kHz	48	48kHz
88.2 kHz	88	88.2kHz
96 kHz	96	96kHz

The setting will be applied only if “**8.3.2 Resolution**” is set to one of “03” to “46”.

**Note:**

LC monitors do not support some audio formats. Select an audio format and sampling frequency supported by the device.

### 8.3.9 Dolby Digital Plus audio

---

You can set the Dolby Digital Plus audio to be output from the source device.

Menu F28

WEB menu EDID SETTINGS → AUDIO FORMAT → Dolby Digital+

Setting value

[Table 8.15] Dolby Digital Plus audio

Description	Front	WEB browser
OFF [Default]	oFF	OFF
32 kHz	32	32kHz
44.1 kHz	44	44.1kHz
48 kHz	48	48kHz

The setting will be applied only if “8.3.2 Resolution” is set to one of “03” to “46”.

**Note:**

LC monitors do not support some audio formats. Select an audio format and sampling frequency supported by the device.

### 8.3.10 DTS audio

---

You can set the DTS audio to be output from the source device.

Menu F30

WEB menu EDID SETTINGS → AUDIO FORMAT → DTS

Setting value

[Table 8.16] DTS audio

Description	Front	WEB browser
OFF [Default]	oFF	OFF
32 kHz	32	32kHz
44.1 kHz	44	44.1kHz
48 kHz	48	48kHz
96 kHz	96	96kHz

The setting will be applied only if “8.3.2 Resolution” is set to one of “03” to “46”.

**Note:**

LC monitors do not support some audio formats. Select an audio format and sampling frequency supported by the device.

### 8.3.11 DTS-HD audio

---

You can set the DTS-HD audio to be output from the source device.

Menu **F32**  
 WEB menu EDID SETTINGS → AUDIO FORMAT → DTS-HD  
 Setting value

[Table 8.17] DTS-HD audio

Description	Front	WEB browser
OFF [Default]	oFF	OFF
44.1 kHz	44	44.1kHz
48 kHz	48	48kHz
88.2 kHz	88	88.2kHz
96 kHz	96	96kHz
176.4 kHz	176	176.4kHz
192 kHz	192	192kHz

The setting will be applied only if “**8.3.2 Resolution**” is set to one of “03” to “46”.

**Note:**

LC monitors do not support some audio formats. Select an audio format and sampling frequency supported by the device.

### 8.3.12 Dolby TrueHD audio

---

You can set the Dolby TrueHD audio to be output from the source device.

Menu **F34**  
 WEB menu EDID SETTINGS → AUDIO FORMAT → Dolby TureHD  
 Setting value

[Table 8.18] Dolby TrueHD audio

Description	Front	WEB browser
OFF [Default]	oFF	OFF
44.1 kHz	44	44.1kHz
48 kHz	48	48kHz
88.2 kHz	88	88.2kHz
96 kHz	96	96kHz
176.4 kHz	176	176.4kHz
192 kHz	192	192kHz

The setting will be applied only if “**8.3.2 Resolution**” is set to one of “03” to “46”.

**Note:**

LC monitors do not support some audio formats. Select an audio format and sampling frequency supported by the device.

### 8.3.13 Speaker configuration

You can set the number of multiple channels to be output from the source device.

Menu F36  
 WEB menu EDID SETTINGS → SPEAKER CONFIGURATION  
 Setting value

[Table 8.19] Speaker configuration

Description	Front	WEB browser
LR [Default]	02	2CH
2.1 channel surround sound	03	2.1CH
5.1 channel surround sound	06	5.1CH
7.1 channel surround sound	08	7.1CH

The setting will be applied only if “8.3.2 Resolution” is set to one of “03” to “46”.

#### ■ The number of channels and speaker configuration

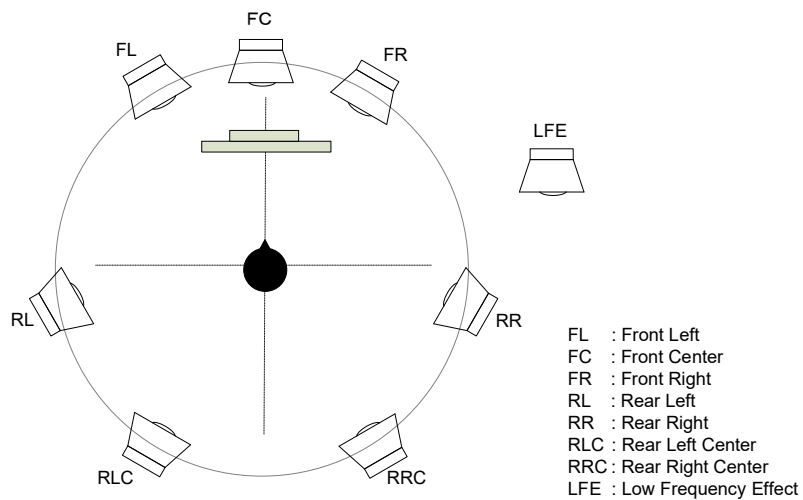

Sound type (Number of speakers)	FL/FR	LFE	FC	RL/RR	RLC/RRC
LR (2)	ON	OFF	OFF	OFF	OFF
2.1 channel surround sound (3)	ON	ON	OFF	OFF	OFF
5.1 channel surround sound (6)	ON	ON	ON	ON	OFF
7.1 channel surround sound (8)	ON	ON	ON	ON	ON

[Fig. 8.7] The number of channels and speaker configuration

**Note:**

Some LC monitors do not support multi-channel audio.

### 8.3.14 Copying CEC physical address

You can copy CEC physical address of the sink device that is connected to OUT1 to the VAC-S EDID. CEC passes through between IN1 and OUT1.

Menu	F38
WEB menu	EDID SETTINGS → CEC ADDRESS COPY
Setting value	

[Table 8.20] CEC physical address

Description	Front	WEB browser
Not copying physical address [Default]	oFF	OFF
Copying physical address	on	OUT1

The setting will be applied only if CEC-supported source device and sink device is connected and “8.3.2 Resolution” is set to one of “03” to “46”.

If the CEC physical address of the connected sink device and VAC-S’s address are not the same, the CEC functions, such as input switching in the sink device at start-up, may not work correctly. The problem can be solved by using the CEC physical address that is copied in the VAC-S.

CEC physical address that is set for the VAC-S’s EDID are displayed on the CEC PHYSICAL ADDRESS:” column of the WEB browser.

**Note:**

CEC system link functions supported by other manufacturers’ are not guaranteed to work correctly by this setting. Check the actual configuration.

### 8.3.15 Frame rate

If selecting 2160p and 4096x2160 EDID resolutions, the frequency will be 30 Hz or 25 Hz. For other resolutions, the frequency will be 60 Hz or 50 Hz.

Menu	F40
WEB menu	EDID SETTINGS → FRAME RATE
Setting value	

[Table 8.21] Frame rate

Description	Front	WEB browser
OFF [Default]	oFF	60Hz/30Hz
ON	on	50Hz/25Hz

You can set the video frequency that is output from source device.

The setting will be applied only if “8.3.2 Resolution” is set to one of “03” to “46”.

## 8.4 Audio

### 8.4.1 Stable audio input wait

Menu	C06
WEB menu	INPUT AUDIO SETTINGS → STABLE WAIT
Setting value	

[Table 8.22] Stable audio input wait

Description	Front	WEB browser
No wait (Disabled)	oFF	OFF
Short	01	SHORT
Middle [Default]	02	MIDDLE
Long	03	LONG

This feature is for waiting until input audio becomes stable in order to avoid popping noise when audio source is turned on or the like.

If initial digital sound cannot be output, disable this feature. In such a case, however, unstable input signal may become noise.

### 8.4.2 Outputting audio

You can enable/disable digital audio that is output from each output channel.

Menu	F70 to F77: OUT1 to OUT8, F78 : AUDIO OUT (VAC-S12U only)
WEB menu	OUTPUT AUDIO SETTINGS → OUTPUT SIGNAL
Setting value	

[Table 8.23] Outputting audio

Description	Front	WEB browser
ON [Default]	on	ON
OFF	oFF	OFF

### 8.4.3 Audio to be output

VAC-S12U only

Menu	F80 to F81: OUT1 to OUT2, F88: AUDIO OUT
WEB menu	OUTPUT AUDIO SETTINGS → SOURCE SELECTION
Setting value	

[Table 8.24] Audio selection

Description	Front	WEB browser
Digital input audio [Default]	dig	DIGITAL
Analog input audio	AnA	ANALOG

## 8.4.4 Output audio for when no video signal is input

VAC-S12U only

Menu	C68 ~ C69 : OUT1 ~ OUT2
WEB menu	OUTPUT AUDIO SETTINGS → AUDIO ONLY OUTPUT
Setting value	

[Table 8.25] Output audio for when no video signal is input

Description	Front	WEB browser
ON	on	ON
OFF [Default]	oFF	OFF

“ON”: Follows the setting of “**Audio to be output (P.47)**”. Black image is output at an optimal resolution of the connected sink device. In this case, “**Presence of output signal for when no signal is input (P.56)**” is disabled.

“OFF”: No audio or video is output.

## 8.5 Input

### 8.5.1 HDCP input

Menu	C01
WEB menu	INPUT SETTINGS → HDCP INPUT MODE
Setting value	

[Table 8.26] HDCP input

Description	Front	WEB browser
Enabling HDCP 2.2 and HDCP 1.4 [Default]	2.2	HDCP2.2
Enabling HDCP 1.4	1.4	HDCP1.4
Disabling HDCP	oFF	DISABLE

Some source devices negotiate with the connected device to determine if HDCP encryption is supported. After this negotiation, the source device determines whether HDCP signal encryption is enforced or not. This process takes place with some source device, even if the content being presented is not copyright protected. The VAC-S is HDCP compliant, if it is connected to a display device that does not support HDCP, even unprotected AV content may not be successfully displayed. Under these circumstances and if the content is indeed not protected, the problem can be solved by setting this menu to “DISABLE.”

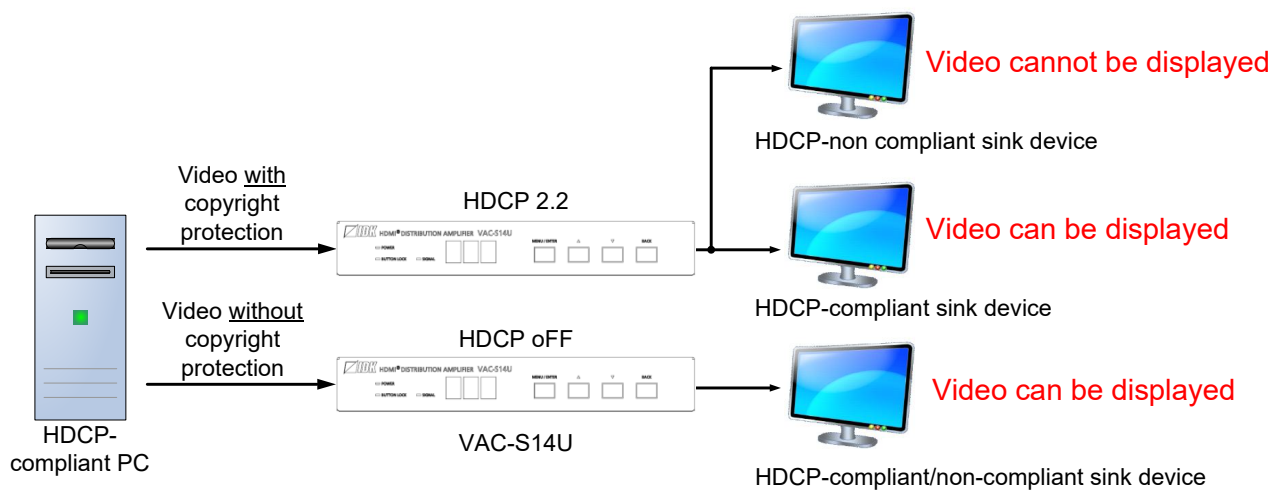

[Fig. 8.8] HDCP-compliant and HDCP non-compliant sink device

**Notes:**

Set this setting to “2.2”/“HDCP2.2” in order to display video with copyright protection.

- HDCP 2.2 (stream type 0) contents can be displayed on sink devices supporting HDCP 2.2/HDCP 1.4.
- HDCP 2.2 (stream type 1) contents can be displayed on sink devices supporting HDCP 2.2 but cannot be displayed on sink devices supporting HDCP 1.4.

## 8.5.2 No-signal input monitoring

If you change the EDID settings of the VAC-S or power the VAC-S off/on, the source device may not output a video signal. Use this menu to set the monitoring time. This is the interval beginning when a source device is not outputting a signal; and ending at the point when the VAC-S requests an output from that source device.

Menu F16  
 WEB menu INPUT SETTINGS → NO INPUT MONITORING  
 Setting value

[Table 8.27] No-signal input monitoring

Description	Front	WEB browser
OFF	oFF	OFF
2 sec. to 15 sec. [Default] 10 sec.	02 to 15	2 to 15

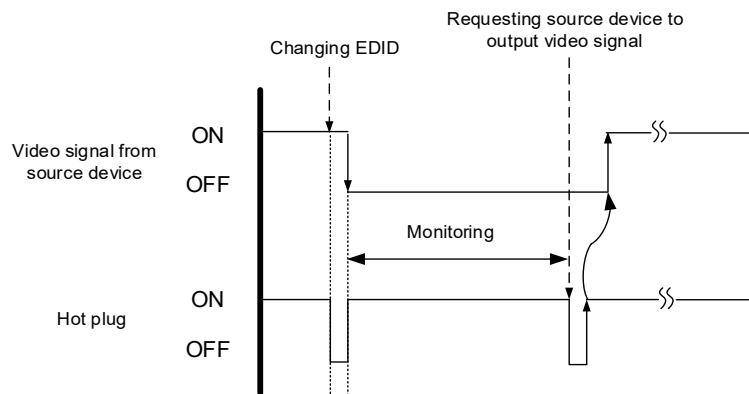

[Fig. 8.9] Monitoring absence of input

**Notes:**

If you are using the monitor power-saving or dual monitor features on your PC, set this feature to “OFF”. This will avoid potentially unpredictable operation.

When using this feature, ensure that the “monitoring time” is set for a value greater than the amount of time needed for the source to provide an output signal.

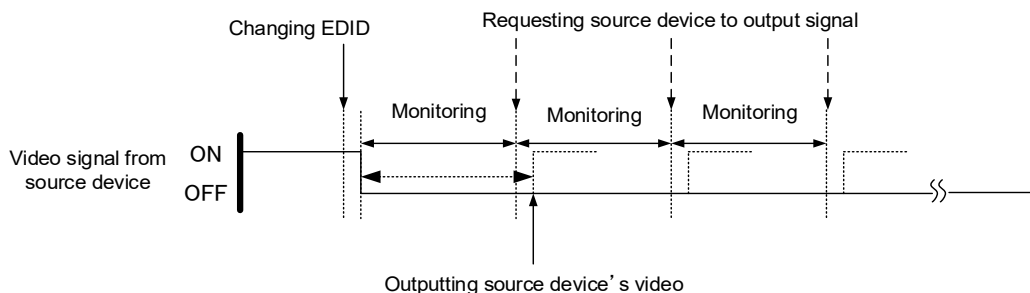

[Fig. 8.10] Monitoring absence of input

## 8.6 Output

### 8.6.1 Hot plug ignoring duration

Time for ignoring the video output request signals sent from the sink device.

Menu C10 to C17: OUT1 to OUT8  
 WEB menu OUTPUT SETTINGS → HOTPLUG MASK  
 Setting value

[Table 8.28] Hot plug ignoring duration

Description	Front	WEB browser
Not ignoring request signals [Default]	oFF	OFF
2 to 15 [sec.]	02 to 15	2 to 15

If the request signals are repeated in a short cycle, the VAC-S processes video output from the first cycle. As a result, video may not be output. This problem can be solved by setting the ignoring time.

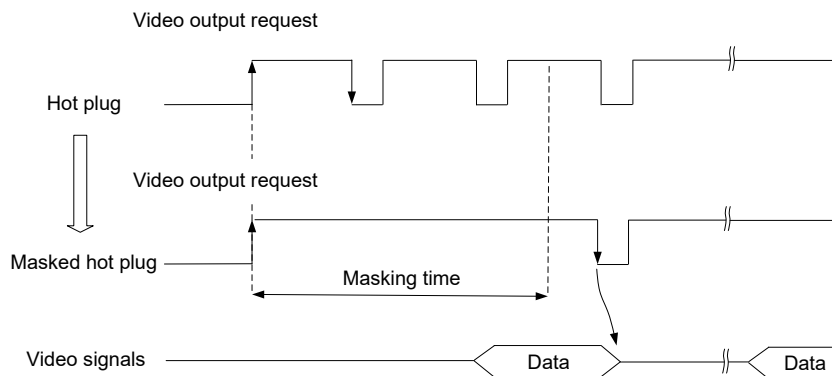
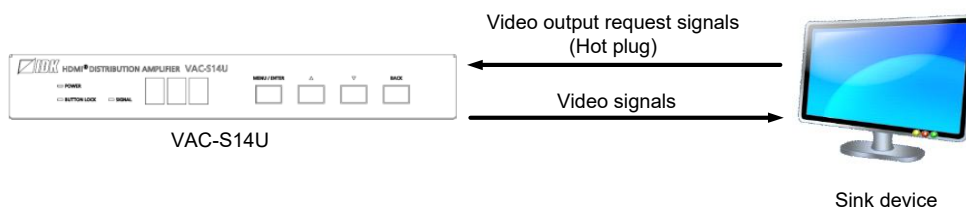

[Fig. 8.11] Hot plug mask

## 8.6.2 Sink device EDID check

You can set the sink device's EDID detection mode.

Menu	C20 to C27: OUT1 to OUT8
WEB menu	OUTPUT SETTINGS → EDID ERR. OUTPUT MODE
Setting value	

**[Table 8.29] Sink device EDID check**

Description	Front	WEB browser
In case of EDID load error, the sink device is treated as a DVI device [Default]	oFF	OFF
In case of EDID load error, the sink device is treated as a HDMI device without SCDC	Er1	ERROR1 (NO SCDC)
Always treats sink device as a HDMI device without SCDC	AL1	ALWAYS1 (NO SCDC)
In case of EDID load error, the sink device is treated as a HDMI device with SCDC	Er2	ERROR2 (SCDC)
Always treats sink device as a HDMI device with SCDC	AL2	ALWAYS2 (SCDC)

The VAC-S gets EDID from the sink device and determines if the sink device is an HDMI device or DVI device. However, if the VAC-S cannot get EDID for some reasons, problems such as no audio output and the like may occur. In these cases, VAC-S recognized the connected sink device is HDMI or DVI device and output signal as HDMI or DVI mode depending on its setting.

**Notes:**

- This setting is applied when HDMI signal is input and “**8.6.3 Output format**” is set to a format other than DVI.
- If setting this menu to a value other than the default (oFF, OFF), set “**8.3.2 Resolution**” to a value other than “01” (External EDID) and select an EDID that is supported by the sink device.

### 8.6.3 Output format

---

You can select an output signal mode and color space of the output video.

The selected mode has priority and is output to the sink device with the optimal mode.

Menu C30 to C37: OUT1 to OUT8

WEB menu OUTPUT SETTINGS → SIGNAL FORMAT

Setting value

**[Table 8.30] Output format**

Description	Front	WEB browser
AUTO [Default]	FoL	FOLLOW SINK DEVICE
RGB output	rgb	HDMI RGB MODE
YCbCr 4:2:2 output	422	HDMI YCbCr 4:2:2 MODE
YCbCr 4:4:4 output	444	HDMI YCbCr 4:4:4 MODE
DVI output	d	DVI MODE
YCbCr 4:2:0 output	420	HDMI YCbCr 4:2:0 MODE

**Notes:**

- This setting is applied when HDMI signal is input.
- When 4K@50/59.94/60 signal is input, the VAC-S outputs the signal at YCbCr 4:2:0 to the sink device supporting YCbCr 4:2:0 (not supporting YCbCr 4:4:4).
- For 4K YCbCr 4:2:0, only CEA-861 Video Format Timings are supported.
- YCbCr 4:2:0 output is available only for 4K@50/59.94/60 output, for other resolution the format is set to "AUTO".
- DVI output is 4K@30 or less input signals.  
If "DVI" is selected, digital audio is not output.

## 8.6.4 Down conversion output

The VAC-S can down convert 2160p into 1080p. Only OUT1 supports this feature.

Menu	C40: OUT1
WEB menu	OUTPUT SETTINGS → DOWN CONVERSION
Setting value	

**[Table 8.31] Down conversion**

Description	Front	WEB browser
Automatic* [Default]	FoL	FOLLOW SINK DEVICE
OFF	oFF	OFF
ON	on	ON

\*Automatic: If the sink device supports only up to 2K, signals are down converted automatically.

**[Table 8.32] Down-converted resolution**

Input resolution	Converted resolution
3840x2160p 24Hz	1920x1080p 24Hz
3840x2160p 25Hz	1920x1080p 25Hz
3840x2160p 30Hz	1920x1080p 30Hz
3840x2160p 50Hz	1920x1080p 50Hz
3840x2160p 60Hz	1920x1080p 60Hz

## 8.6.5 Presence of output signal for when signal is input

---

Video/audio can be off or muted for each output.

**Menu** C50 to C57: OUT1 to OUT8

**WEB menu** CHANNEL SELECT → OUTPUT SIGNAL  
OUTPUT SETTINGS → OUTPUT SIGNAL

**Setting value**

**[Table 8.33] Presence of input signal for when signal is input**

Description		Front	WEB browser
Video output ON	Audio output ON [Default]	on	SOURCE ON
Video output OFF	Audio output OFF	oFF	SOURCE OFF
Black output ON	Audio output OFF	bL1	V&A MUTE
Black output ON	Audio output ON	bL2	VIDEO MUTE
Video output ON	Audio output OFF	bL3	AUDIO MUTE

Video output OFF, Audio output OFF : No video, audio, or +5 V signal is output. The sink devices can be in standby state.

Black output ON : A black screen is displayed on sink devices. The sink devices are not in standby state.  
Available only if video signal is input.

Audio output OFF : No HDMI audio is output. The sink devices are not in standby state. Analog audio is not muted.

If selecting, Video output OFF, Black output ON, or Audio output OFF, the BACK button enables/disables this menu's setting.

## 8.6.6 Presence of output signal for when no signal is input

---

You can enable/disable to output the +5 V signal when no video signal is input.

Menu C60 to C67: OUT1 to OUT8

WEB menu OUTPUT SETTINGS → DDC POWER CONTROL

Setting value

**[Table 8.34] Presence of input signal for when no signal is input**

Description		Front	WEB browser
ON	Outputs +5 V signal at all times. [Default]	on	ON
OFF	0 sec. Stops outputting +5 V signal immediately if no video signal is input.	oFF	OFF (0)
	1 sec. to 60 sec. Stops outputting +5 V signal after the lapse of set time if no video signal is input.	01 to 60	OFF (1 to 60)

If a sink device is not switched to standby status even without signal to be input, set this menu to “OFF”.

## 8.7 LAN

### 8.7.1 IP address

You can set the IP address.

Menu C80: ①  
C81: ②  
C82: ③  
C83: ④

WEB menu LAN SETTINGS → PARAMETERS → IP ADDRESS

Setting value

[Table 8.35] IP address

Description		Front	WEB browser
000.000.000.000 to 255.255.255.255 : [Default] 192.168.001.199	①	000 to 255	0 to 255
	②	000 to 255	0 to 255
	③	000 to 255	0 to 255
	④	000 to 255	0 to 255

192.168.001.199

①      ②      ③      ④

**Note:**

If multiple VAC-S units are in a network, assign different IP addresses for each VAC-S unit.

## 8.7.2 Subnet mask

You can set the subnet mask.

Menu C84

WEB menu LAN SETTINGS → PARAMETERS → SUBNET MASK

Setting value

[Table 8.36] Subnet mask

Description	Front	Description	Front
0.0.0.0	1	255.255.0.0	17
128.0.0.0	2	255.255.128.0	18
192.0.0.0	3	255.255.192.0	19
224.0.0.0	4	255.255.224.0	20
240.0.0.0	5	255.255.240.0	21
248.0.0.0	6	255.255.248.0	22
252.0.0.0	7	255.255.252.0	23
254.0.0.0	8	255.255.254.0	24
255.0.0.0	9	255.255.255.0 [Default]	25
255.128.0.0	10	255.255.255.128	26
255.192.0.0	11	255.255.255.192	27
255.224.0.0	12	255.255.255.224	28
255.240.0.0	13	255.255.255.240	29
255.248.0.0	14	255.255.255.248	30
255.252.0.0	15	255.255.255.252	31
255.254.0.0	16	255.255.255.254	32

Description	WEB browser
000.000.000.000 to 255.255.255.254	0 to 255
[Default] 255.255.255.000	0 to 255
	0 to 255
	0 to 254

### 8.7.3 TCP port number

Menu C85  
 WEB menu LAN SETTINGS → PARAMETERS → PORT NUMBER  
 Setting value

[Table 8.37] TCP port number

Description	Front	WEB browser
Up to 4 connections can be used [Default]	4	CONNECTION: 4 (1100, 6000 to 6999)
Up to 8 connections can be used	8	CONNECTION: 8 (1100, 6000 to 6999)

“Up to 4 connections can be used” : Connections will be divided into 4 for WEB browser control (HTTP port number is fixed “80”) and 4 for communication command control at maximum.

“Up to 8 connections can be used” : Connections will be assigned to 8 communication command controls at maximum.

**Notes:**

- If setting this menu to “Up to 8 connections can be used”, WEB browser cannot be used any more.
- You can change the port number from communication command or WEB browser.
- The default port number for communication command control is “1100”.

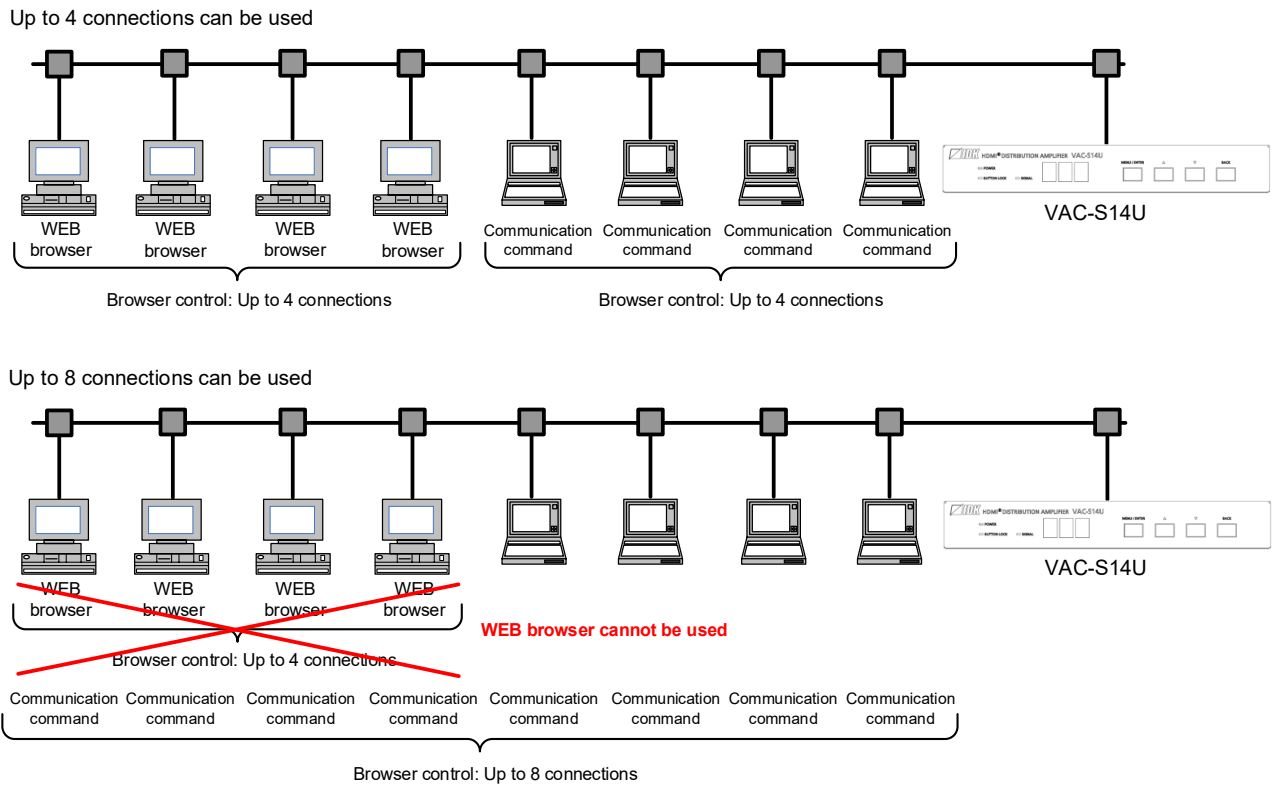

[Fig. 8.12] 8 connection setting

## 8.7.4 MAC address

---

Menu C86

WEB menu LAN SETTINGS → PARAMETERS → MAC ADDRESS

You can display the VAC-S's MAC address.

## 8.8 Configuring VAC-S

---

### 8.8.1 Reboot

---

You can reboot the VAC-S.

Menu C91

WEB menu SYSTEM SETTINGS → REBOOT

Setting value

**[Table 8.38] Reboot**

Description	Front	WEB browser
Reboot	rb	REBOOT

### 8.8.2 Grouping front panel security lockout

---

You can set front panel security lockout that prevents accidental changes to the controller settings.

Menu C92

WEB menu SYSTEM SETTINGS → BUTTON LOCK

Setting value

**[Table 8.39] Target buttons of security lockout**

Description	Front*	WEB browser
ALL [Default]	ALL	ALL
MENU/ENTER	SE	MENU/ENTER
BACK/▲/▼	bC	BACK

\*To enable/disable the security lockout from the front, press and hold the "BACK" button for three seconds.

**[See: 7.3 Front panel security lockout]**

### 8.8.3 Power saving mode

---

You can enable/disable the energy saving function. Lights of menu operation buttons are turned off automatically after 30 seconds of inactivity.

Menu	C93
WEB menu	SYSTEM SETTINGS → POWER SAVE MODE
Setting value	

[Table 8.40] Energy saving

Description	Front	WEB browser
Disabled [Default]	oFF	OFF
Enabled	on	ON

**Note:**

This setting is not applied to Status LED and 7-segment display

### 8.8.4 Version

---

Menu	F90
WEB menu	VIEW STATUS → VERSION

You can view the firmware version.

## 8.8.5 Displaying/Hiding menu

Menu **F99**

Setting value

**[Table 8.41] Setting menu display**

Description	Front
Hide [Default]	oFF
Display (Hide at start-up after reboot)	on
Always display (Display at start-up after reboot)	ALL

Setting value	Menu		
	Setting menu	Maintenance	Status indication
oFF	Display	Hide	Hide
on	Display	Hide at next start-up after reboot	Hide at next start-up after reboot
ALL	Display	Displayed	Displayed

**Note:**

This menu cannot be set from the WEB browser.

## 8.9 Status indication

### 8.9.1 Input signal status

You can view the information for input.

Menu  L01 to L22

WEB menu  VIEW STATUS → INPUT STATUS

[Table 8.42] Input status

[1/3]

Menu number	Value to be displayed	Description
● HDMI/DVI mode and color depth of input video		
L01	H24	HDMI mode 24 bit/pixel (8 bit/component)
	H30	HDMI mode 30 bit/pixel (10 bit/component)
	H36	HDMI mode 36 bit/pixel (12 bit/component)
	d24	DVI mode 24 bit/pixel (8 bit/component)
	- - -	No signal is input.
● Presence of input HDCP		
L02	on	With HDCP
	oFF	Without HDCP
	- - -	No signal is input.
● Presence of input video HDCP encryption (Encryption from source device)		
L03	1.4	Encrypted (HDCP 1.4)
	2.2	Encrypted (HDCP 2.2)
	oFF	Not encrypted
	- - -	No signal is input.
● Color space of input video		
L04	rgb	RGB
	422	YCbCr 4:2:2
	420	YCbCr 4:2:0
	444	YCbCr 4:4:4
	- - -	Unknown, No signal is input.
● Input video frequency		
L05	59.9	Input vertical synchronous frequency (Example: 59.94 Hz)
	- - -	No signal is input.
● +5 V signal		
L06	on	+5 V signal is input
	oFF	No +5 V signal is input
● Input signal resolution		
L07	1920_1080P	Displaying (scroll) input resolution. (Example: 1920×1080p 60 Hz)
	60	
	- - -	No signal is input.

Menu number	Value to be displayed	Description
<ul style="list-style-type: none"> <li>• Audio input type and the number of channels  n*: 1 = 2 channels, 2 = 2.1 channels, 5 = 5.1 channels, 7 = 7.1 channels</li> </ul>		
L10	---	Unknown, No signal is input.
	00n	Unknown
	01n	LINEAR PCM Audio
	02n	AC-3 Dolby Digital Audio
	03n	MPEG-1 Audio
	04n	MP3 Audio
	05n	MPEG-2 Audio
	06n	AACLC Audio
	07n	DTS Audio
	08n	ATRAC Audio
	09n	DSD Audio
	10n	Dolby Digital Plus Audio
	11n	DTS-HD Audio
	12n	Dolby TrueHD Audio
	13n	DST Audio
14n	WMA Audio	
15n	HE-AAC/HE-AACv2/MPEG Surround Audio	
<ul style="list-style-type: none"> <li>• Audio input sampling frequency</li> </ul>		
L11	22	22.05 kHz
	24	24 kHz
	32	32 kHz
	44	44.1 kHz
	48	48 kHz
	88	88.2 kHz
	96	96 kHz
	176	176.4 kHz
	192	192 kHz
	768	768 kHz
	_01	Unknown
	_05	
	_07	
	_11	
	_13	
_15		
---	No signal is input.	

Menu number	Value to be displayed	Description
● The number of audio input bits, HBR mode (High Bit-Rate Audio)		
L12	H16	16 bit, HBR mode
	P16	16 bit, PCM mode
	_16	16 bit, compression audio other than HBR and PCM modes
	H20	20 bit, HBR mode
	P20	20 bit, PCM mode
	_20	20 bit, compression audio other than HBR and PCM modes
	H24	24 bit, HBR mode
	P24	24 bit, PCM mode
	_24	24 bit, compression audio other than HBR and PCM modes
---	No signal is input.	
● Audio input (Digital audio)		
L13	000	No audio is input.
	001	Input is being detected.
	002	Audio is input normally.
	---	No signal is input.
● Scrambling of input signal		
L20	on	Scrambled (4K format except for YCbCr 4:2:0)
	oFF	Not scrambled.
	---	No signal is input.
● TMDS clock ratio of input signal		
L21	1_1	1/1
	1_4	1/4 (4K format except for YCbCr 4:2:0)
	---	No signal is input.
● Input signal stream type (for HDCP 2.2)		
L22	000	Type 0
	001	Type 1
	non	HDCP 1.4 or no HDCP signal
	---	No signal is input.

**[Table 8.43] Input status (WEB browser)**

WEB browser menu	Value	Description
<b>Video signal</b>		
● Input signal resolution		
FORMAT	1920x1080p 60.00Hz	Input resolution (example: 1920×1080p 60 Hz)
● HDMI/DVI mode of input signal		
INPUT MODE	HDMI MODE	HDMI mode
	DVI MODE	DVI mode
● Presence of input HDCP and stream type		
HDCP	HDCP 2.2 Type1	HDCP 2.2 stream Type 1 signal
	HDCP 2.2 Type0	HDCP 2.2 stream Type 0 signal
	HDCP 1.4	HDCP 1.4 signal
	NOT ENCRYPTED	No HDCP signal
● Color space of input signal		
COLOR SPACE	4:4:4 LIMITED RANGE YUV709	YCbCr 4:4:4
	4:2:2 LIMITED RANGE YUV709	YCbCr 4:2:2
	4:2:0 LIMITED RANGE YUV709	YCbCr 4:2:0
	RGB DEFAULT	RGB
● Color depth of input video		
DEEP COLOR	24 BIT COLOR	24 bit/pixel (8bit/component)
	30 BIT COLOR	30 bit/pixel (10bit/component)
	36 BIT COLOR	36 bit/pixel (12bit/component)
● Scrambling of input signal		
SCRAMBLE	SCRAMBLE ON	Scrambled (4K format except for YCbCr 4:2:0)
	SCRAMBLE OFF	Not scrambled.
<b>Audio signal</b>		
● Audio input format		
FORMAT	LINEAR PCM	LPCM (for LPCM)
● Audio input sampling frequency		
SAMPLING FREQUENCY	48 kHz	Sample frequency (for 48 kHz)
● The number of audio input channels		
CHANNEL	2 CHANNEL	The number of channels (for 2 channel)
● Audio input bit		
BIT LENGTH	24 BIT	Sampling bit length (for 24 bit)

## 8.9.2 Sink device status

You can view the information for output.

Menu L30 to LL7

WEB menu VIEW STATUS → SINK DEVICE STATUS / SINK DEVICE EDID

[Table 8.44] Sink device status

[1/2]

Menu number	Value to be displayed	Description
● Color depth (sink)		
L30 (OUT1) to L37 (OUT8)	24	24 bit/pixel (8 bit/component) supported
	30	30 bit/pixel (10 bit/component) supported
	36	36 bit/pixel (12 bit/component) supported
	---	Not connected
● Color space (sink)		
L40 (OUT1) to L47 (OUT8)	rgb	RGB supported
	422	YCbCr 4:2:2 supported
	444	YCbCr 4:4:4 supported
	444_420	Scroll display If sink device resolution is 4K@50/59.94/60, up to YCbCr 4:2:0.
---	Not connected	
● Color space (output)		
L50 (OUT1) to L57 (OUT8)	rgb	RGB output
	422	YCbCr 4:2:2 output
	420	YCbCr 4:2:0 output
	444	YCbCr 4:4:4 output
	---	Not connected
● Hot plug detection		
L60 (OUT1) to L67 (OUT8)	on	Hot plug is detected.
	oFF	No hot plug is detected.
● HDMI/DVI		
L70 (OUT1) to L77 (OUT8)	HC	HDMI mode (Compressed audio supported)
	HP	HDMI mode (PCM audio supported)
	d	DVI mode (Audio is not supported.)
	---	Not connected
● HDCP encryption		
L80 (OUT1) to L87 (OUT8)	000	None
	001	Being encrypted
	002	
	003	
	004	Encryption ends normally.
	005	Encryption ends abnormally.

Menu number	Value to be displayed	Description
<b>• HDCP</b>		
L90 (OUT1) to L97 (OUT8)	1.4	HDCP 1.4 supported
	2.2	HDCP supported (HDCP 2.2)
	oFF	HDCP is not supported or no HDCP signal
	---	Not connected
<b>• SCDC</b>		
LA0 (OUT1) to LA7 (OUT8)	on	SCDC supported
	oFF	SCDC is not supported.
	---	Not connected
<b>• Scrambling output</b>		
Lb0 (OUT1) to Lb7 (OUT8)	on	Scrambled
	oFF	Not scrambled.
	---	Not connected
<b>• HDR</b>		
LC0 (OUT1) to LC7 (OUT8)	on	HDR supported
	oFF	HDR is not supported.
	---	Not connected
<b>• 3D</b>		
Ld0 (OUT1) to Ld7 (OUT8)	on	3D supported
	oFF	3D is not supported.
	---	Not connected
<b>• HDCP output</b>		
LF0 (OUT1) to LF7 (OUT8)	non	No HDCP output
	1.4	HDCP 1.4 output
	h2.2	HDCP 2.2 Type 0 output
	H2.2	HDCP 2.2 Type 1 output
	ERR	Authentication error
	---	Not connected
<b>• HDMI/DVI output</b>		
LH0 (OUT1) to LH7 (OUT8)	H	HDMI output
	d	DVI output
	---	Not connected
<b>• Color range output</b>		
LL0 (OUT1) to LL7 (OUT8)	F	Full range output
	L	Limited range output
	---	Not connected

**[Table 8.45] Output status (WEB browser)**

[1/2]

WEB browser menu	Value to be displayed	Description
<b>Output signal</b>		
● HDCP encryption		
HDCP AUTHENTICATION	HDCP 2.2 Type 1	HDCP 2.2 Type 1 encryption
	HDCP 2.2 Type 0	HDCP 2.2 Type 0 encryption
	HDCP 1.4	HDCP 1.4 encryption
	HDCP CHECK NOW	Being encrypted
	HDCP NOT ENCRYPTED	HDCP is not supported.
	HDCP ERROR	Encryption ends abnormally
	HDCP NOT SUPPORT	Sink device supports HDCP.
● HDMI/DVI output		
OUTPUT MODE	HDMI MODE	HDMI output
	DVI MODE	DVI output
● Color space (output)		
COLOR SPACE	RGB	RGB output
	422	YCbCr 4:2:2 output
	444	YCbCr 4:4:4 output
	420	YCbCr 4:2:0 output
● Color range output		
COLOR RANGE	LIMITED RANGE	Limited range output
	FULL RANGE	Full range output
● Color depth output		
DEEP COLOR	24 BIT COLOR	24 bit/pixel (8 bit/component) output
	30 BIT COLOR	30 bit/pixel (10 bit/component) output
	36 BIT COLOR	36 bit/pixel (12 bit/component) output
● Scrambling output		
SCRAMBLE	SCRAMBLE ON	With scramble
	SCRAMBLE OFF	No scramble
<b>Sink device information</b>		
● Name		
MONITOR NAME	Depending on connected device	Sink device's name
● Resolution		
RESOLUTION	Depending on connected device	Supported resolution
● HDMI/DVI		
HDMI / DVI	HDMI MODE	HDMI mode
	DVI MODE	DVI mode
● Color space		
COLOR SPACE	RGB	RGB supported
	422	YCbCr 4:2:2 supported
	444	YCbCr 4:4:4 supported
	420	YCbCr 4:2:0 supported

WEB browser menu	Value to be displayed	Description
<b>Sink device information</b>		
● Color depth		
DEEP COLOR	24 BIT COLOR	24 bit/pixel (8 bit/component) supported
	30 BIT COLOR	30 bit/pixel (10 bit/component) supported
	36 BIT COLOR	36 bit/pixel (12 bit/component) supported
● Audio sampling frequency		
PCM FREQUENCY	32 kHz	32 kHz supported
	44 kHz	44.1 kHz supported
	48 kHz	48 kHz supported
	88 kHz	88.2 kHz supported
	96 kHz	96 kHz supported
	176 kHz	176.4 kHz supported
	192 kHz	192 kHz supported
● Audio bit length		
PCM BIT LENGTH	16 BIT	16 BIT supported
	20 BIT	20 BIT supported
	24 BIT	24 BIT supported
● The number of audio channels		
PCM CHANNEL	2 CHANNEL	LR
	3 CHANNEL	2.1 channel surround sound
	6 CHANNEL	5.1 channel surround sound
	8 CHANNEL	7.1 channel surround sound
● Compressed audio		
COMPRESSED AUDIO	SUPPORT	Compressed audio supported
	NOT SUPPORT	Compression audio is not supported.
● HDR		
HDR	SUPPORT	HDR supported
	NOT SUPPORT	HDR is not supported.
● SCDC		
SCDC	SUPPORT	SCDC supported
	NOT SUPPORT	SCDC is not supported.
● 3D		
3D	SUPPORT	3D supported
	NOT SUPPORT	3D is not supported.

### 8.9.3 System status

You can view status of power voltage (DC 12V IN) and internal temperature.

Menu H00 to H02  
 WEB menu VIEW STATUS → SYSTEM STATUS

[Table 8.46] System check

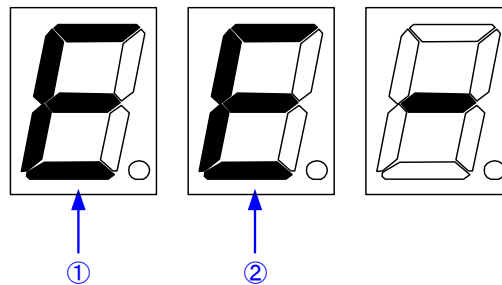

Menu number	Value (Example)	Description
● System status		
H00	---	No error detected
	E E -	Errors in power, power voltage, or internal temperature
	E - -	Error in power (DC 12 V IN) or power voltage (other than DC +12 V ±10%)
	- E -	Error in internal temperature
● Power voltage		
H01	12.0	Shows power voltage.
● Internal temperature		
H02	32.0	Shows internal temperature.

Number	Description
①	Error in power (DC 12 V IN) or power voltage (other than DC +12 V ±10%)
②	Error in internal temperature

[Table 8.47] Values displayed on WEB browser

Menu number	Value (Example)	Description
● Power voltage		
POWER STATUS	12.000 V STATUS:OK	Shows power voltage.
● Internal temperature		
TEMPERATURE STATUS	32.0 C STATUS:OK	Shows internal temperature.

**Note:**

In case an error is detected, [STATUS:NG] is displayed in red on the WEB browser.  
 In case an alarm is output, the VAC-S itself may have problems. Please contact us.

## 8.10 Operations only settable from WEB menu

---

You can operate following menus only from a WEB.

### 8.10.1 Editing channel and device names

---

Click the [NAME EDIT] button in [CHANNEL SELECT] menu to open the [NAME EDIT] window.

You can enter up to 10 one-byte characters or 40 one-byte characters for channel name or model type/device name, respectively.

The edited channel names are applied to the submenu tab and [STATUS] window.

### 8.10.2 Automatic updating time

---

#### SYSTEM SETTINGS > AUTO RELOAD TIME

You can set the automatic updating time of [CHANNEL SELECT] and [VIEW STATUS] windows by selecting the desired value (5 to 60 seconds, 5-second interval) from [AUTO RELOAD TIME] in the [SYSTEM SETTINGS] menu.

This menu is only for [CHANNEL SELECT] and [VIEW STATUS] windows; other windows cannot be updated automatically even if you select the desired number.

If you select [OFF] (default), [CHANNEL SELECT] and [VIEW STATUS] windows are not updated automatically.

### 8.10.3 Saving/Restoring all settings

---

#### SYSTEM SETTINGS > BACKUP/RESTORE

To save saved settings to a PC as a backup file:

1. Select [SYSTEM SETTINGS] from [MENU].
2. Click the [BACKUP] button of [BACKUP/RESTORE].
3. When the confirmation message appears, click the [OK] button. The backup file named with the ".idm" extension will be saved to the PC. You can change the file name.

To restore settings from PC:

1. Select [SYSTEM SETTINGS] from [MENU].
2. Select a file from [Choose File].
3. Click the [RESTORE] button of [BACKUP/RESTORE].  
Do not perform other WEB operations or power off the VAC-S during the operation.
4. If the restoration fails, an alert dialog appears during the operation.

## 8.10.4 Initialization

---

### SYSTEM SETTINGS > INITIALIZATION

You can initialize settings other than LAN communication settings by clicking the [NORMAL INITIALIZATION] button.

If you want to initialize all settings including LAN communication settings, click the [ALL INITIALIZATION] button.

Once settings are initialized, they cannot be restored.  
After initialization, the VAC-S reboots automatically.

## 9 License

---

The following table shows the licensed third-party software packages used by the VAC-S. Transferring, copying, disassembling, decompiling, or reverse-engineering the included software other than open source software that is licensed by GPL, LGPL, or other licenses are prohibited.

OSS	License	URL
FreeRTOS	MIT	<a href="https://github.com/aws/amazon-freertos/blob/main/LICENSE">https://github.com/aws/amazon-freertos/blob/main/LICENSE</a>

# 10 Product specification

## 10.1 VAC-S12U

Item		Description
Input		1 input HDMI/DVI 1.0 TMDS single link, HDCP 1.4/2.2 x.v.Color/3D (*1)/HDR (*2)/CEC (Pass-through) ARC/HEC are not supported. Connector: 1 female HDMI Type A (19-pin)
Output		2 outputs HDMI/DVI 1.0 TMDS single link, HDCP 1.4/2.2 x.v.Color/3D (*1)/HDR (*2)/CEC (Pass-through) ARC/HEC are not supported. Connector: 2 female HDMI Type A (19-pin)
Format		VGA to 4K 480i / 480p / 576i / 576p / 720p / 1080i / 1080p / 4K For 4K formats, 24 Hz/25 Hz/30 Hz/50 Hz (4:4:4)/60 Hz are supported.
Color depth		24 bit, 30 bit, 36 bit Deep Color For 4K@50/59.94/60 RGB/YCbCr 4:4:4, 24 bit is supported.
Dot clock		25 MHz to 600 MHz
TMDS clock		25 MHz to 300 MHz
TMDS data rate		0.75 Gbps to 18 Gbps
Plug & Play		DDC2B (can be selected from Built-in EDID, Copied EDID, or EDID of connected monitor) Built-in EDID: The maximum resolution can be selected.
Digital audio input		Multi-channel LPCM up to 8 channels Sampling frequency: 32 kHz to 192 kHz, Sample size: 16 bit to 24 bit Reference level: -20 dBFS, Max. input level: 0 dBFS
Digital audio output		Multi-channel LPCM up to 8 channels Sampling frequency: 32 kHz to 192 kHz, Sample size: 16 bit to 24 bit Reference level: -20 dBFS, Max. output level: 0 dBFS
Analog audio input		1 input Stereo L/R Unbalance signal Input impedance: 24k $\Omega$ , Reference level: -10 dBu, Max input level: +10 dBu Connector: 1 captive screw (3-pin)
Analog audio output		1 output Unbalanced Stereo LR Output impedance: 50 $\Omega$ , Reference level: -10 dBu, Max. output level: +10 dBu Connector: 1 captive screw (3-pin)
Maximum transmission distances	Digital input	98 ft. (30 m) (1080p@60), 39 ft. 12 m (4K@60) (*3)
	Digital output	98 ft. (30 m) (1080p@60), 39 ft. 12 m (4K@60) (*3)
Control	LAN	1 port/RJ-45 10Base-T/100Base-TX (Auto Negotiation), Auto MDI/MDI-X
Functions		WEB browser control, Anti-Snow, Connection Reset (*4), Button security lockout, OUT1 supports down conversion (4K to 1080p), Status notification, Each video output OFF, I/O signal status display, System check
General	AC adapter	Input : 100 - 240 VAC $\pm$ 10%, 50 Hz/60 Hz $\pm$ 3 Hz Output : DC 12 V 3 A 36.0 W (A dedicated AC adapter is provided)
	Power consumption	6 W
	Dimensions	4.2 (W) $\times$ 1.7 (H) $\times$ 5.9 (D)" (106 (W) $\times$ 42 (H) $\times$ 150 (D) mm) (Quarter rack wide, thin type) (Excluding connectors and the like)
	Weight	1.3 lbs. (0.6 kg)
	Temperature	Operating : 32°F to 104°F (0°C to +40°C) Storage : -4°F to +176°F (-20°C to +80°C)
	Humidity	Operating/Storage: 20% to 90% (Non Condensing)

\*1 3D is supported if external EDID is selected while a 3D-supported sink device is connected for EDID setting or if copied EDID of 3D-supported sink device is selected for EDID setting. Input 3D signal is output from all output connectors.

\*2 HDR is supported if external EDID is selected while an HDR-supported sink device is connected for EDID setting or if copied EDID of an HDR-supported sink device is selected for EDID setting. Input HDR signal is output from all output connectors.

\*3 The maximum cable distance varies depending on the connected devices and was measured under following conditions:

• 1080p@60: When Signals of 1080p@60 24 bit/pixel (8 bit/component) was input or output.

• 4K@60 : When IDK's 18 Gbps supported cable was used and signals of 4K@60 24 bit/pixel (8 bit/component) was input or output.

The maximum cable distance depends on the connected devices. The distance may not be extended with some device combinations, cabling method, or other manufacturer's cable. Video may be disturbed or may not be output even if signals are within the range mentioned above.

\*4 For digital systems, some problems, such as an HDCP authentication error, can often be recovered by physically disconnecting and reconnecting the digital cables. However, the Connection Reset feature will fix these problems automatically without the need to physically plug and unplug the cables. It creates the same condition as if the cable were physically disconnected and reconnected. This feature only works for the VAC-S's output. If other devices are connected between the VAC-S's output and sink device, this feature may be invalid.

## 10.2 VAC-S14U

Item		Description
Input		1 input HDMI/DVI 1.0 TMDS single link, HDCP 1.4/2.2 x.v.Color/3D (*1)/HDR (*2)/CEC (Pass-through) ARC/HEC are not supported. Connector: 1 female HDMI Type A (19-pin)
Output		4 outputs HDMI/DVI 1.0 TMDS single link, HDCP 1.4/2.2 x.v.Color/3D (*1)/HDR (*2)/CEC (Pass-through) ARC/HEC are not supported. Connector: 4 female HDMI Type A (19-pin)
Format		VGA to 4K 480i / 480p / 576i / 576p / 720p / 1080i / 1080p / 4K For 4K formats, 24 Hz/25 Hz/30 Hz/50 Hz (4:4:4)/60 Hz (4:4:4) are supported.
Color depth		24 bit, 30 bit, 36 bit Deep Color For 4K@50/59.94/60 RGB/YCbCr 4:4:4, 24 bit is supported.
Dot clock		25 MHz to 600 MHz
TMDS clock		25 MHz to 300 MHz
TMDS data rate		0.75 Gbps to 18 Gbps
Plug & Play		DDC2B (can be selected from Built-in EDID, Copied EDID, or EDID of connected monitor) Built-in EDID: The maximum resolution can be selected.
Digital audio input		Multi-channel LPCM up to 8 channels Sampling frequency: 32 kHz to 192 kHz, Sample size: 16 bit to 24 bit Reference level: -20 dBFS, Max. input level: 0 dBFS
Digital audio output		Multi-channel LPCM up to 8 channels Sampling frequency: 32 kHz to 192 kHz, Sample size: 16 bit to 24 bit Reference level: -20 dBFS, Max. output level: 0 dBFS
Analog audio output		1 output Unbalanced Stereo LR Output impedance: 50 Ω, Reference level: -10 dBu, Max. output level: +10 dBu Connector: 1 captive screw (3-pin)
Maximum transmission distances	Digital input	98 ft. (30 m) (1080p@60), 39 ft. 12 m (4K@60) (*3)
	Digital output	98 ft. (30 m) (1080p@60), 39 ft. 12 m (4K@60) (*3)
Control	LAN	1 port/RJ-45 10Base-T/100Base-TX (Auto Negotiation), Auto MDI/MDI-X
Functions		WEB browser control, Anti-Snow, Connection Reset (*4), Button security lockout, OUT 1 supports down conversion (4K to 1080p), Status notification, Each video output OFF, I/O signal status display, System check
General	AC adapter	Input : 100 - 240 VAC ±10%, 50 Hz/60 Hz ±3 Hz Output : DC 12 V 3 A 36.0 W (A dedicated AC adapter is provided)
	Power consumption	About 14 W
	Dimensions	8.3 (W) × 1.2 (H) × 5.9 (D)" (210 (W) × 30 (H) × 150 (D) mm) (Half rack wide, thin type) (Excluding connectors and the like)
	Weight	2.4 lbs. (1.1 kg)
	Temperature	Operating : 32°F to 104°F (0°C to +40°C) Storage : -4°F to +176°F (-20°C to +80°C)
	Humidity	Operating/Storage: 20% to 90% (Non Condensing)

- \*1 3D is supported if external EDID is selected while a 3D-supported sink device is connected for EDID setting or if copied EDID of 3D-supported sink device is selected for EDID setting. Input 3D signal is output from all output connectors.
- \*2 HDR is supported if external EDID is selected while an HDR-supported sink device is connected for EDID setting or if copied EDID of an HDR-supported sink device is selected for EDID setting. Input HDR signal is output from all output connectors.
- \*3 The maximum cable distance varies depending on the connected devices and was measured under following conditions:  
 • 1080p@60: When IDK's 24 AWG cable was used and signals of 1080p@60 24 bit/pixel (8 bit/component) was input or output.  
 • 4K@60 : When IDK's 18 Gbps supported cable was used and signals of 4K@60 24 bit/pixel (8 bit/component) was input or output.  
 The maximum cable distance depends on the connected devices. The distance may not be extended with some device combinations, cabling method, or other manufacturer's cable. Video may be disturbed or may not be output even if signals are within the range mentioned above.
- \*4 For digital systems, some problems, such as an HDCP authentication error, can often be recovered by physically disconnecting and reconnecting the digital cables. However, the Connection Reset feature will fix these problems automatically without the need to physically plug and unplug the cables. It creates the same condition as if the cable were physically disconnected and reconnected. This feature only works for the VAC-S's output. If other devices are connected between the VAC-S's output and sink device, this feature may be invalid.

## 10.3 VAC-S16U

Item		Description
Input		1 input HDMI/DVI 1.0 TMDS single link, HDCP 1.4/2.2 x.v.Color/3D (*1)/HDR (*2)/CEC (Pass-through) ARC/HEC are not supported. Connector: 1 female HDMI Type A (19-pin)
Output		6 outputs HDMI/DVI 1.0 TMDS single link, HDCP 1.4/2.2 x.v.Color/3D (*1)/HDR (*2)/CEC (Pass-through) ARC/HEC are not supported. Connector: 6 female HDMI Type A (19-pin)
Format		VGA to 4K 480i / 480p / 576i / 576p / 720p / 1080i / 1080p / 4K For 4K formats, 24 Hz/25 Hz/30 Hz/50 Hz (4:4:4)/60 Hz (4:4:4) are supported.
Color depth		24 bit, 30 bit, 36 bit Deep Color For 4K@50/59.94/60 RGB/YCbCr 4:4:4, 24 bit is supported.
Dot clock		25 MHz to 600 MHz
TMDS clock		25 MHz to 300 MHz
TMDS data rate		0.75 Gbps to 18 Gbps
Plug & Play		DDC2B (can be selected from Built-in EDID, Copied EDID, or EDID of connected monitor) Built-in EDID: The maximum resolution can be selected.
Digital audio input		Multi-channel LPCM up to 8 channels Sampling frequency: 32 kHz to 192 kHz, Sample size: 16 bit to 24 bit Reference level: -20 dBFS, Max. input level: 0 dBFS
Digital audio output		Multi-channel LPCM up to 8 channels Sampling frequency: 32 kHz to 192 kHz, Sample size: 16 bit to 24 bit Reference level: -20 dBFS, Max. output level: 0 dBFS
Analog audio output		1 output Unbalanced Stereo LR Output impedance: 50 Ω, Reference level: -10 dBu, Max. output level: +10 dBu Connector: 1 captive screw (3-pin)
Maximum transmission distances	Digital input	98 ft. (30 m) (1080p@60), 39 ft. 12 m (4K@60) (*3)
	Digital output	98 ft. (30 m) (1080p@60), 39 ft. 12 m (4K@60) (*3)
Control	LAN	1 port/RJ-45 10Base-T/100Base-TX (Auto Negotiation), Auto MDI/MDI-X
Functions		WEB browser control, Anti-Snow, Connection Reset (*4), Button security lockout, OUT 1 supports down conversion (4K to 1080p), Status notification, Each video output OFF, I/O signal status display, System check
General	AC adapter	Input : 100 - 240 VAC ±10%, 50 Hz/60 Hz ±3 Hz Output : DC 12 V 3 A 36.0 W (A dedicated AC adapter is provided)
	Power consumption	About 18 W
	Dimensions	8.3 (W) × 1.7 (H) × 5.9 (D)" (210 (W) × 42 (H) × 150 (D) mm) (Half rack wide, 1U high) (Excluding connectors and the like)
	Weight	2.9 lbs. (1.3 kg)
	Temperature	Operating : 32°F to 104°F (0°C to +40°C) Storage : -4°F to +176°F (-20°C to +80°C)
	Humidity	Operating/Storage: 20% to 90% (Non Condensing)

- \*1 3D is supported if external EDID is selected while a 3D-supported sink device is connected for EDID setting or if copied EDID of 3D-supported sink device is selected for EDID setting. Input 3D signal is output from all output connectors.
- \*2 HDR is supported if external EDID is selected while an HDR-supported sink device is connected for EDID setting or if copied EDID of an HDR-supported sink device is selected for EDID setting. Input HDR signal is output from all output connectors.
- \*3 The maximum cable distance varies depending on the connected devices and was measured under following conditions:  
 • 1080p@60: When IDK's 24 AWG cable was used and signals of 1080p@60 24 bit/pixel (8 bit/component) was input or output.  
 • 4K@60 : When IDK's 18 Gbps supported cable was used and signals of 4K@60 24 bit/pixel (8 bit/component) was input or output.  
 The maximum cable distance depends on the connected devices. The distance may not be extended with some device combinations, cabling method, or other manufacturer's cable. Video may be disturbed or may not be output even if signals are within the range mentioned above.
- \*4 For digital systems, some problems, such as an HDCP authentication error, can often be recovered by physically disconnecting and reconnecting the digital cables. However, the Connection Reset feature will fix these problems automatically without the need to physically plug and unplug the cables. It creates the same condition as if the cable were physically disconnected and reconnected. This feature only works for the VAC-S's output. If other devices are connected between the VAC-S's output and sink device, this feature may be invalid.

## 10.4 VAC-S18U

Item		Description
Input		1 input HDMI/DVI 1.0 TMDS single link, HDCP 1.4/2.2 x.v.Color/3D (*1)/HDR (*2)/CEC (Pass-through) ARC/HEC are not supported. Connector: 1 female HDMI Type A (19-pin)
Output		8 outputs HDMI/DVI 1.0 TMDS single link, HDCP 1.4/2.2 x.v.Color/3D (*1)/HDR (*2)/CEC (Pass-through) ARC/HEC are not supported. Connector: 8 female HDMI Type A (19-pin)
Format		VGA to 4K 480i / 480p / 576i / 576p / 720p / 1080i / 1080p / 4K For 4K formats, 24 Hz/25 Hz/30 Hz/50 Hz (4:4:4)/60 Hz (4:4:4) are supported.
Color depth		24 bit, 30 bit, 36 bit Deep Color For 4K@50/59.94/60 RGB/YCbCr 4:4:4, 24 bit is supported.
Dot clock		25 MHz to 600 MHz
TMDS clock		25 MHz to 300 MHz
TMDS data rate		0.75 Gbps to 18 Gbps
Plug & Play		DDC2B (can be selected from Built-in EDID, Copied EDID, or EDID of connected monitor) Built-in EDID: The maximum resolution can be selected.
Digital audio input		Multi-channel LPCM up to 8 channels Sampling frequency: 32 kHz to 192 kHz, Sample size: 16 bit to 24 bit Reference level: -20 dBFS, Max. input level: 0 dBFS
Digital audio output		Multi-channel LPCM up to 8 channels Sampling frequency: 32 kHz to 192 kHz, Sample size: 16 bit to 24 bit Reference level: -20 dBFS, Max. output level: 0 dBFS
Analog audio output		1 output Unbalanced Stereo LR Output impedance: 50 Ω, Reference level: -10 dBu, Max. output level: +10 dBu Connector: 1 captive screw (3-pin)
Maximum transmission distances	Digital input	98 ft. (30 m) (1080p@60), 39 ft. 12 m (4K@60) (*3)
	Digital output	98 ft. (30 m) (1080p@60), 39 ft. 12 m (4K@60) (*3)
Control	LAN	1 port/RJ-45 10Base-T/100Base-TX (Auto Negotiation), Auto MDI/MDI-X
Functions		WEB browser control, Anti-Snow, Connection Reset (*4), Button security lockout, OUT 1 supports down conversion (4K to 1080p), Status notification, Each video output OFF, I/O signal status display, System check
General	AC adapter	Input : 100 - 240 VAC ±10%, 50 Hz/60 Hz ±3 Hz Output : DC 12 V 3 A 36.0 W (A dedicated AC adapter is provided)
	Power consumption	About 22 W
	Dimensions	8.3 (W) × 1.7 (H) × 5.9 (D)" (210 (W) × 42 (H) × 150 (D) mm) (Half rack wide, 1U high) (Excluding connectors and the like)
	Weight	2.9 lbs. (1.3 kg)
	Temperature	Operating : 32°F to 104°F (0°C to +40°C) Storage : -4°F to +176°F (-20°C to +80°C)
	Humidity	Operating/Storage: 20% to 90% (Non Condensing)

- \*1 3D is supported if external EDID is selected while a 3D-supported sink device is connected for EDID setting or if copied EDID of 3D-supported sink device is selected for EDID setting. Input 3D signal is output from all output connectors.
- \*2 HDR is supported if external EDID is selected while an HDR-supported sink device is connected for EDID setting or if copied EDID of an HDR-supported sink device is selected for EDID setting. Input HDR signal is output from all output connectors.
- \*3 The maximum cable distance varies depending on the connected devices and was measured under following conditions:  
 • 1080p@60: When IDK's 24 AWG cable was used and signals of 1080p@60 24 bit/pixel (8 bit/component) was input or output.  
 • 4K@60 : When IDK's 18 Gbps supported cable was used and signals of 4K@60 24 bit/pixel (8 bit/component) was input or output.  
 The maximum cable distance depends on the connected devices. The distance may not be extended with some device combinations, cabling method, or other manufacturer's cable. Video may be disturbed or may not be output even if signals are within the range mentioned above.
- \*4 For digital systems, some problems, such as an HDCP authentication error, can often be recovered by physically disconnecting and reconnecting the digital cables. However, the Connection Reset feature will fix these problems automatically without the need to physically plug and unplug the cables. It creates the same condition as if the cable were physically disconnected and reconnected. This feature only works for the VAC-S's output. If other devices are connected between the VAC-S's output and sink device, this feature may be invalid.

# 11 Troubleshooting

This chapter provides recommendations in case difficulties are encountered during VAC-S setup and operation.

In case the VAC-S does not work correctly, please check the following items first.

- Are the VAC-S and all devices connected to power and powered on?
- Are signal cables connected correctly?
- Are there any loose or partially mated connections?
- Are the interconnecting cables specified correctly to support adequate bandwidth?
- For 4K format, is an 18 Gbps high-speed cable used?
- Are specifications of connected devices matched to each other?
- Are configuration settings for the connected devices correct?
- Is there any nearby equipment that may cause electrical noise/RF interference?

If the problem persists, review the following section for guidelines and recommendations. Refer to the manuals of connected devices as well, since they may possibly be the cause of the problem.

Problem	Cause/Check item/Solution	Page
• Video output		
Video is not being output.	[1] Is the EDID resolution setting of this device set to the input resolution supported by the sink device? <ul style="list-style-type: none"> <li>• EDID resolution is set to 2160p 4:4:4 by factory default. Some TVs does not support the resolution.</li> <li>• If the EDID resolution is set to 1080i, the video may not be output to the sink device that does not support the interlaced signals.</li> <li>• PC output resolutions (VGA to WQXGA) may not be output to LCD TVs and plasma TVs.</li> </ul>	36 [F10]
	[2] Does the "SIGNAL" LED illuminate? Yes : Check [3] to [8]. No : Check [9] to [11].	16
	[3] Check the presence of HDCP? 1.4 : Signal protected by HDCP 1.4. 2.2 : Signal protected by HDCP 2.2. oFF: The signal is not protected.	63 [L03]
	[4] Does the sink device support HDCP? If HDCP protected signal is input [3], video is not displayed on the sink device that does not support HDCP. [oFF] or [- - -]: Sink device's resolution may not be supported. Check the specification of the sink device. Some HDMI/DVI devices check if the connected device is HDCP compliant and determines whether to output HDCP signal or not. Since the VAC-S is HDCP compliant, the VAC-S may not output video if connected to a sink device that does not support HDCP. In such a case, disable the HDCP input from the source device.	67 [L9n]*  49 [C01]

\*VAC-S12U: n = 0 to 1, VAC-S14U: n = 0 to 3, VAC-S16U: n = 0 to 5, VAC-S18U: n = 0 to 7

Problem	Cause/Check item/Solution	Page
● Video output (Cont'd)		
Video is not being output.	<p>[5] If HDCP 2.2 signal is input, check whether the sink device supports HDCP 2.2.</p> <p>Step 1: Check input signal stream type.</p> <ul style="list-style-type: none"> <li>▪ 000 : Video is displayed to all HDCP 1.4/HDCP 2.2-compliant devices.</li> <li>▪ 001 : Video is displayed only to HDCP 2.2-compliant devices.</li> </ul> <p>Step 2: Check if HDCP is supported.</p>	65 [L22]       67 [L9n]*
	<p>[6] Is the resolution supported by the sink device? Check the resolution and video frequency of input signal. Sink device's resolution may not be supported. Check the specification of the sink device.</p>	63 [L07]
	<p>[7] Does the sink device support SCDC?</p> <p>① Check TMDS clock ratio of input signal.</p> <ul style="list-style-type: none"> <li>▪ 1_4 : SCDC signal</li> <li>▪ 1_1 : Not SCDC signal.</li> </ul> <p>② Check if the sink device supports SCDC.</p> <ul style="list-style-type: none"> <li>▪ on : SCDC supported.</li> <li>▪ oFF: SCDC is not supported; vide is not displayed.</li> </ul>	65 [L21]     67 [LAn]*
	<p>[8] Change the setting of Hot plug ignoring duration.</p>	51 [C1n]*
	<p>[9] If a long cable is connected for HDMI input or HDMI output, replace it with a 16 ft. (5 m) or shorter cable. Even though a 16 ft. (5 m) or longer cable can be connected for HDMI I/O of the VAC-S, HDCP authorization or EDID acquisition may fail depending on the cable quality and the connected device.</p>	—
	<p>[10] The time setting for monitoring no-signal input may be too short.</p>	[F16]
	<p>[11] Check the video output setting of the source device.</p>	—

\*VAC-S12U: n = 0 to 1, VAC-S14U: n = 0 to 3, VAC-S16U: n = 0 to 5, VAC-S18U: n = 0 to 7

Problem	Cause/Check item/Solution	Page
● Video output (Cont'd)		
Video is intermittent, or presents noise.	If using a long cable for HDMI input or HDMI output, replace it with a 16.4 ft. (5 m) or shorter cable. Since the VAC-S has automatic cable length equalization, long cables can be successfully used, but the VAC-S's full performance may not be realized if the cable or connected peripheral devices are of inferior quality. If the error is solved by replacing the cable, the signal may have been degraded due to excessive attenuation or crosstalk. IDK offers high-quality cables and extenders. Please contact us as needed.	—
	When high-speed signals (high resolution: such as 4K; DEEP COLOR signal) are input or output, video may not be displayed or noise may appear. This is largely dependent on cable quality and the characteristics of connected peripheral devices. If the problem occurs in all inputs, it is related to the input side of the system. If the problem occurs only in a specific output connector, it is being caused by difficulties ahead of that output. One possible solution is to change to a lower resolution format and/or set Deep Color to "24 bit". You can check the resolution and color depth of the input signal in input signal status and you can also limit resolution and color depth of input signal as defined by the VAC-S's EDID configuration settings.	36 [F10] 41 [F20]  63
Video flickers	If an interlace signal is input to a sink device that does not support interlace inputs, the video may flicker. Check the format settings for the VAC-S's output port driving the sink device.	36 [F10]
The left, right, top and bottom sides are cut off.	Some sink devices overscan input video, and the video may be cut out. Check the display setting of the sink device.	—
Video is reduced vertically or horizontally.	Some sink devices display input video with full screen mode, and the aspect ratio cannot be kept. Check the display setting of the sink device. With some resolutions, full-screen display cannot be avoided. In that case, change the output resolution of the source device.	—
A black screen is displayed at top, bottom, right and left on PC video or only part of the PC video is displayed, and the rest can be revealed by scrolling with the mouse.	If the PC has the Panel Fit function, select [Scale Full Screen]. If the resolution that is set for the PC and the resolution that is actually output from the PC are not matched, those problems may occur. Check the resolution of the PC and the EDID resolution setting.	36 [F10]
PC's dual monitor cannot be set or the setting is canceled.	If the monitoring function for no-signal input is enabled, the dual monitor function of your PC may not work correctly. In this case, disable the monitoring function.	50 [F16]

Problem	Cause/Check item/Solution	Page
● Video output (Cont'd)		
Down-converted signal is not output.	Does the input resolution support down conversion? Check the input signal resolution. For VAC-S, only OUT1 supports down conversion.	63 [L07]
When video is muted, a black screen is not output.	Is video signal input? A black screen is output only if video signal is input.	63 [L07]
Video is displayed in purple or green.	Some sink devices do not find the color space of the input video correctly, and the video may be displayed in purple or green. Set the correct color space in the output format to solve this problem.	53 [C3n]*
Brightness is improper.	Is HDR signal used? If HDR-non-supported sink device tries to receive HDR signal, the video is displayed with improper brightness. Check if the sink device supports HDR.	67 [LCn]*
● Audio output		
Video is displayed, but audio is not output.	Ensure that audio output is turned on.	47 [F7n]*
	If there are multiple output connectors in the source device, check the audio output setting of the source device.	—
	Ensure that the input audio format is supported by the connected sink device. Typically, LCD monitors may not output 88.2 kHz or higher sampling frequency of LPCM and compressed audio (such as Dolby Digital, DTS, and other formats). In order to play a Blu-ray disc having compressed audio, check the audio output setting of the source device. The source device's audio signal characteristics can be managed by the VAC-S's EDID configuration settings.	41 [F22] to 44 [F34]
	Ensure that DVI signal is not being output from the source device.	63 [L01]
	Ensure that output format is not set to DVI.	53 [C3n]*
	Ensure that output signal is not set to Audio output OFF.	55 [C5n]*
Even though multi-channel audio is played, only 2-channel audio is output	For multi-channel, change the EDID setting which is set to 2-channel audio by default.	45 [F36]
Audio is output from HDMI outputs but not from analog audio outputs.	If compressed audio (such as Dolby Digital, DTS, and other formats) is applied to the input, analog audio is not provided at output. Only 2-channel LPCM is supported.	42 [F24] to 44 [F34]

\*VAC-S12U: n = 0 to 1, VAC-S14U: n = 0 to 3, VAC-S16U: n = 0 to 5, VAC-S18U: n = 0 to 7

Problem	Cause/Check item/Solution	Page
<b>● Audio output (Cont'd)</b>		
Audio is output from analog audio outputs but not from HDMI outputs.	Ensure that audio output is turned on.	47 [F7n]*
	Is the selected resolution supported by the connected sink device? If a PC output resolution (XGA to WQXGA) is selected, some sink devices cannot output audio.	36 [F10]
	Is the selected sampling frequency supported by the connected sink device? Some LCD monitors may not output audio if the sampling frequency is high (typically 88.2 kHz or higher). Audio signal that is output from the source device can be controlled by changing EDID setting.	41 [F22]
Compressed audio (such as Dolby Digital, DTS) is not output from the source device.	Compressed audio input is set to OFF (EDID settings) by factory default. If using compressed audio, change the EDID setting.	42 [F24] to 44 [F34]
	Check the audio output settings of the source device.	—
<b>● Communication command, WEB browser control</b>		
Control commands and WEB browser cannot be issued from PC to the VAC-S.	Are IP address and subnet mask set correctly? For using WEB browser, check if the setting for TCP port connection is enabled for WEB browser.	57 [F80] to 59 [F85]
<b>● Others</b>		
Devices cannot be controlled through CEC.	To use CEC, enable the HDMI link control of the connected devices (such as LCD TVs, Blu-ray recorder, and other formats). CEC is supported only between IN1 and OUT1.	—
	If the CEC physical address of sink device EDID that is connected to OUT1 and the CEC physical address of VAC-S's EDID do not match, input switching or the like may have a problem.	46 [F38]

\*VAC-S12U: n = 0 to 1, VAC-S14U: n = 0 to 3, VAC-S16U: n = 0 to 5, VAC-S18U: n = 0 to 7

If additional assistance is required, please perform the following tests and then contact us.

No.	Checking items	Result
1	The problem occurs at all connectors?	Yes or No
2	Connect the devices using genuine cables without connecting the VAC-S. The problem still cannot be solved? Please contact us for assistance.	Yes or No

## User Guide of VAC-S Series

Ver.2.0.0

Issued on: 3 March 2026

---



### Headquarters

IDK Corporation  
7-9-1 Chuo, Yamato-shi, Kanagawa-pref.  
242-0021 JAPAN  
TEL: +81-46-200-0764 FAX: +81-46-200-0765

Email: [idk\\_eng@idk.co.jp](mailto:idk_eng@idk.co.jp)

URL: [www.idkav.com](http://www.idkav.com)

### USA

IDK America Inc.  
72 Grays Bridge Road Suite 1-C, Brookfield, CT 06804  
TEL: +1-203-204-2445

Email: [sales@idkav.com](mailto:sales@idkav.com)

URL: [www.idkav.com](http://www.idkav.com)

### Europe

IDK Europe GmbH  
Lise-Meitner-Str. 6, D-40878 Ratingen  
TEL: +49-2102-578-301-0

Email: [info@idkav.eu](mailto:info@idkav.eu)

URL: [www.idkav.com](http://www.idkav.com)



### Product information Support

Arvanics Corporation  
7-9-1 Chuo, Yamato-shi, Kanagawa-pref.  
242-0021 JAPAN  
TEL: +81-46-259-6920 FAX: +81-46-259-6930

Email: [info@arvanics.com](mailto:info@arvanics.com)

URL: [www.arvanics.com](http://www.arvanics.com)

Information in this document is subject to change without notice.

©2021 IDK Corporation, all rights reserved. All trademarks mentioned are the property of their respective owners.